



# ACCELERATORS 2021.

Highlights and Annual Report

Deutsches Elektronen-Synchrotron DESY  
A Research Centre of the Helmholtz Association







# ACCELERATORS 2021.

Highlights and Annual Report

## Higher energy for FLASH

The aim of the FLASH2020+ project is to significantly improve the photon beams available to the users of the FLASH facility. A key feature of the upgrade is an increase of the electron beam energy from 1.25 GeV to 1.35 GeV. This will allow FLASH to lase at about 20% shorter wavelengths than before, thus reaching deeper into the water window – the wavelength region in which water is transparent to soft X-rays – and paving the way for new scientific breakthroughs. The energy upgrade is being realised by replacing two old accelerator modules with two improved ones that provide a higher average accelerating gradient of over 30 MV/m – a much better performance than before.

Picture: Freddy Lachmund, DESY





# PETRA IV – anchor facility for the Science City Hamburg Bahrenfeld

Artist's view of the DESY campus in Hamburg with the PETRA IV storage ring (dashed line) and the planned experimental Hall West (left). The storage ring will be built using a "hybrid six-bend achromat" lattice with nine lattice cells per arc. This will allow the sector structure in the existing experimental halls in the east of the storage ring to be maintained in order to reuse the existing infrastructure. In addition, it allows for accommodating two more sectors in the new Hall West, making the whole facility even more efficient (more info: see p. 36).

Picture: Science Communication Lab, DESY

## Contents

➤ Introduction	4
➤ News and events	8
➤ Accelerator operation and construction	22
➤ Highlights · New technology · Developments	34
➤ References	90



# The year 2021 at DESY

## Chairman's foreword

*Dear Colleagues and Friends of DESY,*

German Nobel Laureates in physics and chemistry in 2020 and 2021 and the rapid development of a COVID-19 vaccine through the outstanding research and development work in the BioNTech company: These are spectacular scientific breakthroughs that impressively show the strong German role in worldwide fundamental and applied research.

To open up completely new possibilities of knowledge generation, DESY has a highly ambitious future plan at its two sites to shape the research campus of the 21<sup>st</sup> century. Here, applied research that leverages the potential of cutting-edge research infrastructures and rapid transfer to industry and society will be promoted and shaped in a smart "ecosystem".

To implement this plan in a highly competitive environment, we need to get important construction projects under way quickly in the current funding period so as not to fall behind internationally. This applies to the various construction

projects in the areas of research, transfer and knowledge communication on the DESY sites in Hamburg and Zeuthen, but especially to the PETRA IV project, the world-leading lighthouse in research with synchrotron radiation. With the newly developed revolutionary storage ring technology, the hybrid six-bend achromat (H6BA) lattice, we are pushing the performance of German and European light sources ahead of those in the USA and China.

The lessons learned from the coronavirus pandemic and the acute climate crisis are forcing us to leave our comfort zones. For us at DESY, this means that we are questioning the daily life we have become used to. How will we work and conduct research at DESY in the future? How and how much will we travel in the future? How will we organise a sustainable research campus in the future? How do we coordinate climate-friendly operation for users at our large-scale research facilities without any compromises in quality? Will it then still be possible to be appealing to new user

**Figure 2**  
The newly opened Start-up Labs Bahrenfeld building close to the PETRA III experimental hall "Max von Laue"



groups from academia and industry? If we find the right answers and smart solutions, I am convinced that DESY will remain a future-oriented research centre, perhaps even more diverse and even more climate- and family-friendly, and continue to attract the best talents from all over the world.

In October 2021, we were privileged to host the award ceremony for this year's Karl Heinz Beckurts Prize at DESY. The Karl Heinz Beckurts foundation, which confers the prize, was established by the Helmholtz Association together with Siemens AG. Alongside the prize winner Vasilis Ntziachristos (Helmholtz Zentrum München and TU München), Ingmar Hoerr (formerly CureVac), Uğur Şahin and Özlem Türeci (BioNTech) were also honoured with a special prize. The guests included Roland Busch, CEO of Siemens, who was very impressed by the tour of the DESY site. Personally, I was touched by the first names of the award winners: Vasilis, Ingmar, Uğur, Özlem. There is no shorter or better way to show where our future lies – DESY has lived this diversity since its foundation.

This year, DESY signed the Diversity Charter ("Charta der Vielfalt"), thus becoming part of Germany's largest diversity network. DESY is actively committed to a diverse and prejudice-free working environment and to the appreciation of all employees regardless of their gender and gender identity, nationality, ethnic origin, religion or belief, disability, age, sexual orientation and identity. Here at DESY, we attach great importance to an appreciative working atmosphere, the equality of all employees and a better work-life balance.

Since September 2021, the Start-up Labs Bahrenfeld, a project jointly managed by DESY, Universität Hamburg and

the City of Hamburg, has been the new place for science entrepreneurship on DESY's research campus. The variety of fields covered by our young entrepreneurs is huge, ranging from synchronisation systems to individualised tests for diagnosing cancer.

DESY and the Hamburg University of Applied Sciences (HAW Hamburg) agreed on a new strategic Cooperation for Application and Innovation (KAI) with a focus on joint research and development programmes, dual education as well as innovation and technology transfer. KAI will help shape Hamburg's structural transformation into a science and innovation metropolis in northern Germany.

Finally, I would like to mention our public outreach format "Wissen vom Fass" (Science on tap), in which scientists from Universität Hamburg and DESY explain science topics to the public and answer exciting questions from the world of research. This year, the event was purely digital, but it was just as entertaining and enjoyable for everyone as before.

In these challenging times, I would like to thank our staff and all our national and international users and partners for their valuable contribution to DESY. Please remain very careful in this tricky winter period and beyond. I wish you all the best!

*Yours  
Helmut Dosch*

Helmut Dosch  
Chairman of the DESY Board of Directors



**Figure 1**  
DESY tour during the Karl Heinz Beckurts Prize ceremony in October 2021 (from left): Oliver Seeck, Wim Leemans, Roland Busch (Siemens), Helmut Dosch, Ingmar Hoerr (formerly CureVac), Vasilis Ntziachristos (Helmholtz Zentrum München and TU München), Venetia Ntziachristos, Christian Stegmann, Arik Willner



# Accelerators at DESY

## Introduction

Dear colleagues  
and friends,

As this highlight brochure 2021 underlines, despite a pandemic, we had another very productive and successful year for the Accelerator Division across all facets of our activities: operations, projects, R&D into new methods and concepts, and strengthening our institutional resilience. Hence, I would like to start out by stating how very proud we can all be of all our achievements. During the current COVID-19 pandemic, accelerator-based photon science facilities such as DESY's PETRA III synchrotron radiation source as analytic tools have played a key role in vaccine development and potential drug discovery, and DESY's dedicated staff have again demonstrated their commitment and passion for the work at DESY during the tough pandemic-imposed restrictions and rules in 2021. I am personally extremely grateful to our staff, and I want to wholeheartedly thank everyone who contributed!

As the COVID-19 pandemic swept across Germany in March 2020, the DESY accelerators were put in safe mode, and regular user operation at PETRA III and the FLASH free-electron laser (FEL) facility was suspended until further notice. To help fight the pandemic, virologists and biologists contacted us, and in response DESY set up a fast-track access mode for SARS-CoV-2-relevant research, with PETRA III powered up especially for such studies just a week after the temporary shutdown. We are proud that, in April 2021, results from the joint efforts of a research team led by DESY and of our accelerator and beamline staff, who enabled the key research, were published in *Science*, reporting promising candidates for COVID-19 drugs.

The PETRA IV project – DESY's new flagship project to build the world's brightest hard X-ray ultralow-emittance storage ring – completed its second year of the technical design report (TDR) phase. The new hybrid six-bend achromat (H6BA) lattice for the storage ring has been well received, as it tremendously improves the overall performance of the planned facility and also simplifies the required logistics. A dedicated team, consisting of both plasma acceleration experts and conventional-accelerator experts, has been exploring options for a plasma-based injector for PETRA IV to complement the conventional injection chain. This has led to a publication of a proof-of-principle concept that promises a significantly more compact and energy-efficient injection system.

DESY's pioneering FLASH facility has offered intense laser-like extreme ultraviolet and soft X-ray beams for the past two decades. This is also the facility where much of the technology underlying the European XFEL X-ray laser was first developed and tested. The upgrade project called FLASH2020+ is now in full swing. Since July 2020, the project had been led by seeding expert Enrico Allaria. In September 2021, Lucas Schaper, who worked shoulder to shoulder with Enrico since the start of the project, took over the project lead from Enrico, who moved back to Italy for personal reasons. The project will significantly improve the photon beams available to the users. The upgrade includes modernising the accelerator chain by installing two refurbished higher-gradient superconducting modules (gracing the cover of this highlight brochure) to reach higher electron beam energies – and hence photon energies extending into the oxygen K-edge. The core of the upgrade will be the implementation of external seeding at the full repetition rate of 1 MHz in burst mode in order to make FLASH the first high-repetition-rate FEL with full longitudinal coherence. A major goal for external seeding at FLASH was recently achieved by a proof-of-principle experiment demonstrating the parallel operation of seeded and self-amplified spontaneous emission (SASE) FEL operation. Finally, novel FEL lasing concepts based on variable undulator configurations will be exploited at the FLASH2 beamline to shorten the pulse duration and enable attosecond experiments. Progress is on track to resume operations by August 2022 after the first shutdown for the FLASH2020+ upgrade.

Plasma accelerator research at DESY is focusing on the development of mature plasma accelerators to deploy them in DESY's core research areas in the future. Our activities span plasma theory and simulation, beam-driven plasma accelerators and laser-driven plasma accelerators. Beam-driven plasma accelerators may hold the key to the future of high-energy physics and photon science with the promise to accelerate particle bunches to higher energies over shorter distances than conventional accelerators. Key to the deployment of these novel accelerators is understanding how to maximise the energy transfer efficiency and the beam quality.

Research at the FLASHForward electron-beam-driven plasma accelerator focused on the conservation of longi-

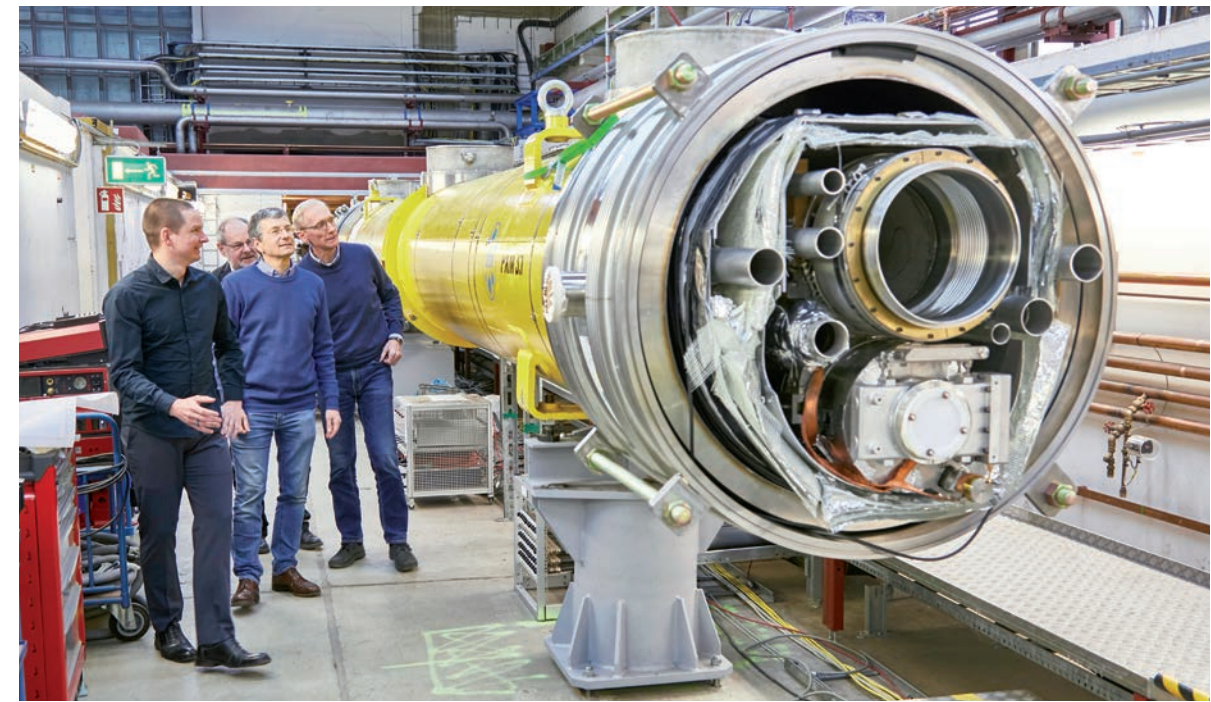

Figure 1  
Inspecting the new improved accelerator modules for the FLASH2020+ project in the FLASH hall (from left: Lucas Schaper, Siegfried Schreiber, Wim Leemans and Edgar Weckert)

tudinal and transverse beam phase space. Significant progress has been made through the development and deployment of a suite of novel diagnostic devices required to optimise the acceleration process, which should make it possible to preserve the beam quality of a further-accelerated beam in the near future. Through careful tuning of the plasma and beam conditions, energy efficiency can be maximised while achieving very high beam quality. We are very proud that our colleague Jens Osterhoff received the 2021 Bjørn H. Wiik Prize in recognition of the many successes the team has achieved in advancing plasma wakefield acceleration concepts.

In the area of laser-driven plasma accelerators, we are also quickly reaching the verge of driving real-world science applications. We have deployed machine learning techniques at the LUX laser plasma accelerator at DESY and recently demonstrated autonomous tuning of the beam quality using intelligent optimisation algorithms and surrogate modelling. Analysing the experimental data with neural networks provided important insights into the root causes of remaining parameter variations in the system. The results guide the development of KALDERA, the next-generation high-repetition-rate laser plasma accelerator at DESY.

On the operational front, we have also focused on increasing the resilience of our research facilities and developing ever more robust, sustainable and flexible solutions that can ensure continuous operation. The COVID-19 crisis created a focus on DESY's digital ways of working – and the concept of DIGITAL DESY was born in response. This includes improved remote user operation, also with a focus on sustainability through reduction of the need for travel, infrastructure monitoring including fault diagnosis and prevention, machine learning efforts and intelligent control algorithms towards our goal of autonomous accelerators.

A virtual workshop (AIRA: Artificial Intelligence and Robotics for Accelerators) was held on 5–8 July 2021, bringing together experts in artificial intelligence (AI), robotics technology, big-data science and industry leaders with those in particle accelerators to determine how the state of the art in robotics must be adapted to the special requirements of accelerator facilities. AI offers the potential to enable the autonomous operation of accelerators and to deliver optimised, finely tuned photon beams *à la carte* for the experiments. A workshop report has been completed, and a follow-up workshop is planned.

At the time of writing, we are all shocked that a senseless war has been launched in Ukraine that is causing tremendous human suffering to its population. This attack on a democratic nation, in the heart of Europe, led by the Russian government is a violation of international law and the European peace order. It also damages the trustful and successful cooperations with Russian institutions that exist in the scientific world. Despite DESY's long tradition of collaborating on various of our projects, all cooperations with Russian institutes had to be suspended, effective immediately. This affects our work on PETRA IV, the European XFEL, FLASH, ARES and further projects, but all this is dwarfed by the pain and suffering that millions of innocent people have to endure. The wave of support and compassion around the world, including at DESY, is heartwarming to see, and hopefully peace will soon return. We stand united with Ukraine and pledge to do everything we can to help.

Wim Leemans  
Director of the Accelerator Division



# Learning how to control plasma-based accelerators

Plasma acceleration at LUX: An intense laser pulse (red) in an ionised gas drives a bubble-shaped plasma wave consisting of electrons (light pink). An electron bunch (centre) riding this wave like a surfer is thus accelerated to high energies over extremely short distances.

The energy distribution of the accelerated electron bunches was significantly reduced by adding nitrogen to the plasma, and much more stable operation was achieved by applying artificial intelligence. The rendering is based on real simulation data from the LUX experiment (more info: see p. 64).

Picture: DESY, Science Communication Lab, Sören J alas and Manuel Kir chen, LUX

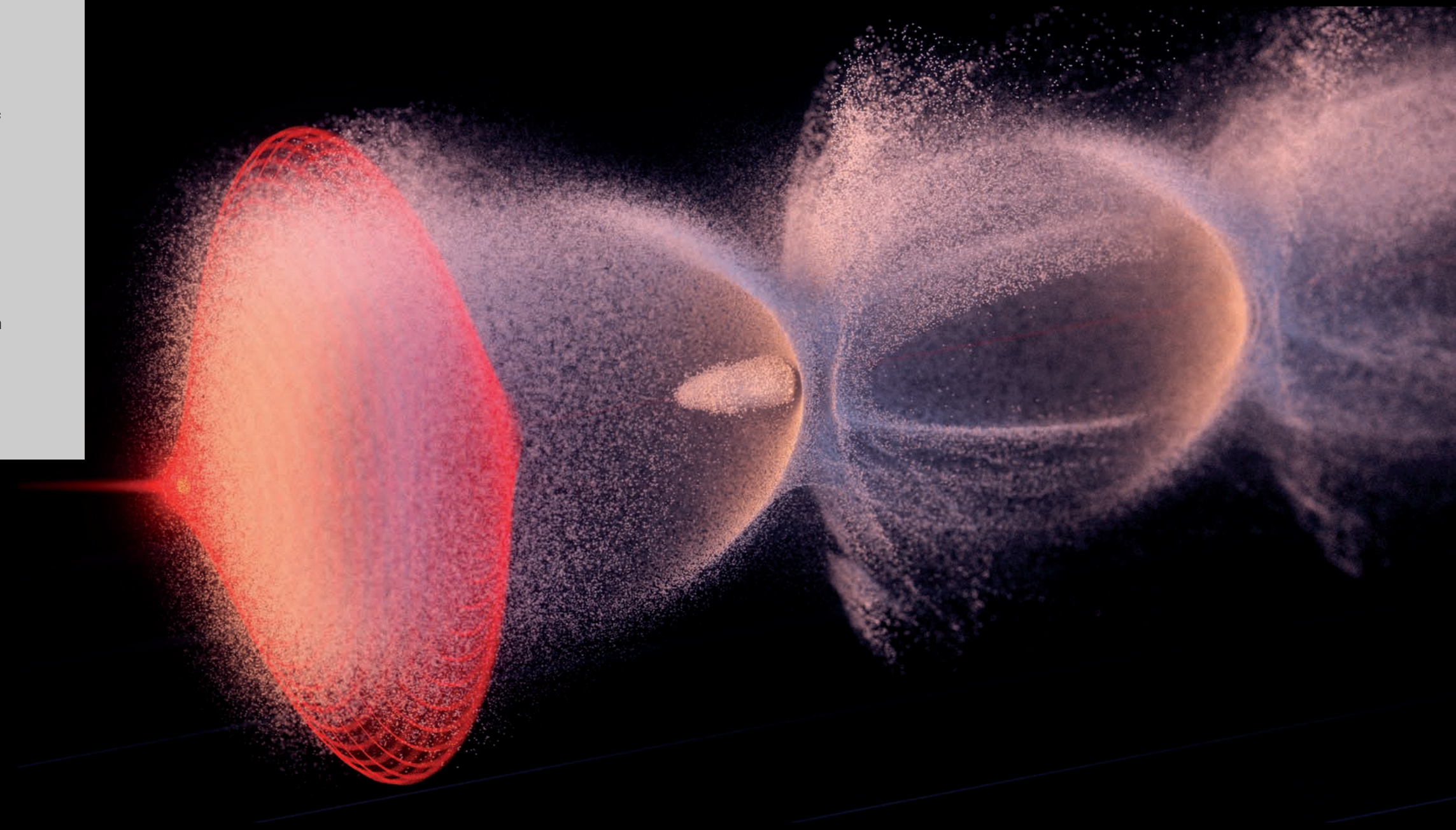

News and events



# News and events

A busy year 2021

## January

### Flattening the wave

The technology of plasma-based acceleration promises to deliver a new generation of powerful and compact particle accelerators. An international research team made a major step forward at DESY's FLASHForward facility by creating precisely tailored particle bunches to ensure optimal acceleration. For the first time, the researchers were able to preserve a sharp energy spectrum within the accelerated particle bunch while simultaneously accelerating particles with record high energy efficiency – both prerequisites for a future application of plasma accelerators in compact next-generation colliders and brilliant photon sources.

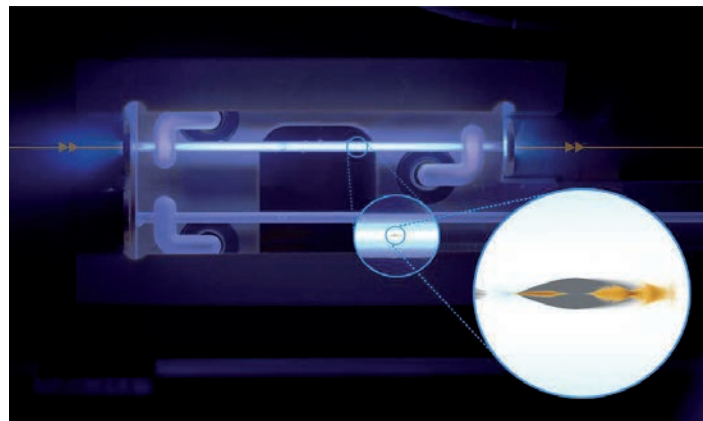

A 50 mm long plasma accelerator module in operation. The blue light is produced during the recombination of argon plasma after a high-voltage discharge. The magnification shows a simulated plasma wakefield corresponding to that of the FLASHForward experiment. It is generated by a leading electron bunch moving to the right; a trailing electron bunch is accelerated quickly and efficiently in it.

Plasma-based accelerators promise to drastically reduce the size of particle accelerator facilities, such as linear colliders and free-electron lasers. A high-energy laser or particle beam shot through a plasma can cause a strong electromagnetic wakefield, which can be used to accelerate charged particles. At FLASHForward, the wakefield in the plasma is formed by an electron bunch fired into the plasma at close to the speed of light. The electrons of this drive bunch force the freely moving plasma electrons to oscillate, resulting in strong electric fields. These fields accelerate electrons in the trailing bunch travelling right behind. The acceleration produced by the plasma wake can

be up to a thousand times higher than that of conventional systems, promising a new generation of more powerful, compact and versatile accelerators that could be used for scientific research as well as in industrial or medical applications.

However, today's experiments at accelerators and colliders demand high energy efficiency and have strict requirements for beam quality, such as the spread of energies within the bunch. This is particularly challenging in plasma accelerators as their high-frequency wakefields typically vary significantly over the length of even short particle bunches, resulting in a spread of the electric fields that accelerate the electrons, again leading to a spread of energies within the bunch.

The theoretical solution to this problem was identified already in the 1980s, shortly after the discovery of plasma wakefields: precise tailoring of the time structure of the trailing bunch. If done correctly, the trailing bunch can drive its own wakefield to destructively interfere with the wakefield from the drive bunch in such a way that all the particles in the trailing bunch are accelerated uniformly. The FLASHForward team has achieved this goal for the first time.

For their experiments, the researchers made use of high-quality, ultrastable electron bunches from the accelerator of DESY's FLASH free-electron laser facility, which supplies FLASHForward with electrons. Using a magnetic chicane, the team divided a FLASH bunch in two – one drive bunch that creates the plasma wakefield and one trailing bunch that is accelerated. Using a new technique for measuring the wave in the plasma very precisely, which they had recently developed, the researchers were able to shape the trailing bunch so precisely that the gradient of its wakefield was flattened over the area where the bunch was accelerated. The plasma was thus ideally prepared to uniformly and efficiently accelerate the electrons.

As a result, the team succeeded in accelerating the 1 GeV electrons of FLASH by 45 MeV while preserving the energy spread within the bunch in the permille regime. In addition to leading to a "flattened" wakefield, the tailored trailing bunch also resulted in a high energy efficiency: In these initial

experiments, the efficiency of energy transfer from wakefield to particles was more than 40%, a factor of almost 2 better than before, which the team aims to improve even further. The result shows that plasma accelerators can be designed to preserve energy spread and operate with high efficiency – yet another key step on the way to creating plasma accelerators for practical applications.

### Hamburg supports DESY's PETRA IV project

Hamburg will support the technology development for DESY's planned large-scale project PETRA IV with 2.85 million euros over the next two years. Funding is provided for the detailed technical planning phase – the technical design report (TDR) – as a precondition for a decision on the inclusion of the project in the German National Research Infrastructure Roadmap and for the application for funding of the overall project.

PETRA IV is set to become the world's best 3D X-ray microscope, providing images of microscopic processes in new materials and in future medical agents that will be hundreds of times more accurate than previously possible. PETRA IV will be the scientific beacon project in the planned Science City Hamburg Bahrenfeld.

Further important financial support with a federal share of 90% is available to DESY from institutional funding by the German Federal Ministry of Education and Research (BMBF), supplemented by a federal state share of 10%.



## April

### Promising candidates for COVID-19 drugs identified at PETRA III

A research team led by DESY identified several candidates for drugs against the SARS-CoV-2 coronavirus at DESY's synchrotron radiation source PETRA III. They bind to an important protein of the virus and could thus be the basis for a drug against COVID-19.

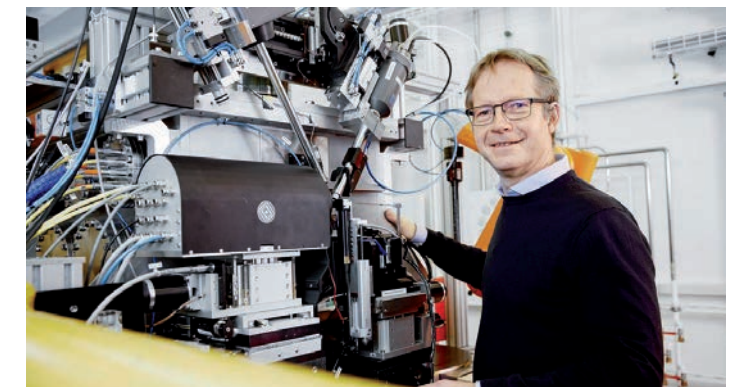

DESY researcher Alke Meents during drug screenings at PETRA III Beamline P11

In an X-ray screening, the researchers quickly tested almost 6000 known active substances that already exist for the treatment of other diseases. After analysing about 7000 samples, the team was able to identify 37 substances that bind to the main protease of the virus, as the scientists reported in *Science*. Seven of these substances inhibit the activity of the protein and thus slow down the multiplication of the virus. Two of them do this so promisingly that they are being further investigated in preclinical studies. The drug screening – probably the largest of its kind – also revealed a new binding site on the main protease of the virus to which drugs can couple.

As the COVID-19 pandemic swept across Germany in March 2020, the DESY accelerators were put in safe mode, and regular user operation at PETRA III and FLASH was suspended until further notice. To help fight the pandemic, DESY set up a fast-track access mode for SARS-CoV-2-relevant research, and PETRA III was powered up especially for such studies. Alongside the screening of potential drugs, these included investigations of infected lung tissue and measurements that played a role in the development of the BioNTech vaccine.



## April

### Milestones in laser plasma acceleration

The LUX team at DESY celebrated two milestones in the development of laser plasma accelerators. The scientists from Universität Hamburg and DESY tested a technique that allows the energy distribution of the generated electron beams to be kept particularly narrow – one of the most essential properties for many potential applications. They also used artificial intelligence to program a self-learning autopilot for the LUX accelerator, which automatically optimises it for maximum performance.

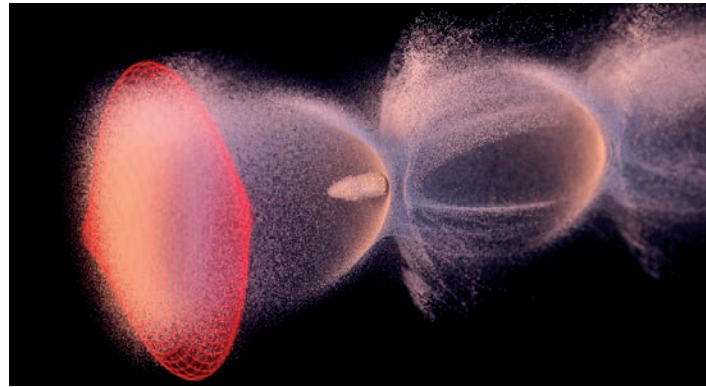

In laser plasma acceleration, an intense laser pulse (red) travelling through an ionised gas drives a bubble-shaped plasma wave consisting of electrons (light pink). An electron bunch (centre) riding this wave like a surfer is accelerated to high energies over extremely short distances. The rendering is based on real simulation data from the LUX experiment.

At LUX, the acceleration takes place in a plasma channel just a few millimetres long. A laser pulse generates a wave within the channel, which can capture and accelerate electrons from the plasma. This compactness is both a blessing and a curse: Plasma wakefield acceleration promises to give rise to a new generation of extremely compact and versatile accelerators. However, since the acceleration takes place in a space that is up to 1000 times smaller than in conventional, large-scale facilities, it occurs under truly extreme conditions. A number of challenges thus still has to be overcome before the technology is ready for series production.

The LUX team achieved a first key milestone by devising a way to significantly narrow the energy distribution of the accelerated electron bunches. To do this, they used a new type of plasma cell, whose channel is divided into two regions. The plasma is generated from a mixture of hydrogen and nitrogen in the front part of the cell, which is about 10 mm long, while the region behind it is filled with pure hydrogen. As a result, the researchers were able to obtain the electrons for their particle bunch from the front part of the plasma cell, which were then accelerated over the entire rear part: As they are more tightly bound, the electrons in the nitrogen are released a little later, which

makes them ideal for being accelerated by the plasma wave. The electron bunch also absorbs energy from the plasma wave, changing the shape of the wave. The team was able to take advantage of this effect and adjust the shape of the wave so that the electrons reached the same energy regardless of their position along the wave.

Based on this recipe for achieving high electron beam quality, the scientists then scored a second success: They used artificial intelligence (AI) to modify an algorithm that controls and optimises the complex plasma accelerator. To do so, they provided the algorithm with a functional model of the accelerator and a set of adjustable parameters, which the algorithm then optimised on its own. Essentially, the system modified five main parameters, including the concentration and density of the gases and the energy and focus of the laser, and used the resulting measurements to search for an operating point at which the electron beam had the optimum quality.

In the course of this balancing act in five-dimensional space, the algorithm constantly learned and very quickly refined the model of the accelerator further and further. As a result, the AI took about an hour to find a stable optimum operating point for the accelerator; by comparison, the team estimated that human beings would need over a week. A further advantage was that all the parameters and measured variables continued to train the accelerator's AI model, making the optimisation process faster, more systematic and more targeted.

This latest progress means that the scientists at LUX are well on their way to trying out initial applications for test purposes. Ultimately, their aim is to use plasma-accelerated electron bunches to operate a free-electron laser.

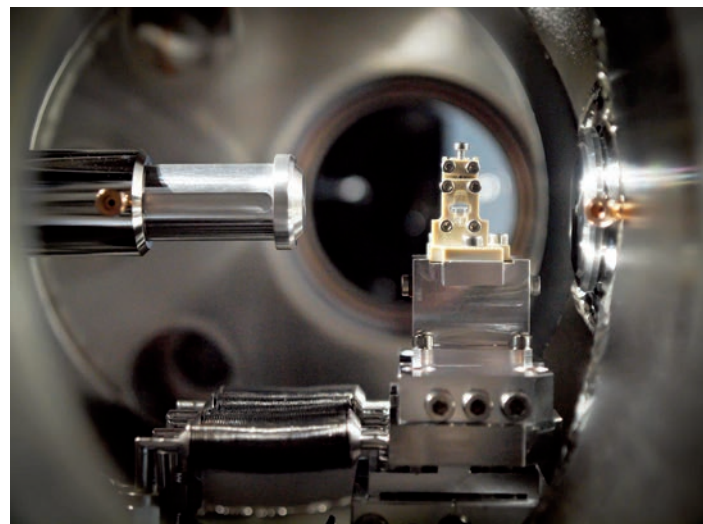

The LUX plasma cell (in the centre of the white mounting), where the electrons are accelerated, is just a few millimetres long.

### Innovation for light sources in Europe

On 20 and 21 April, an online kick-off meeting with over 140 participants marked the launch of LEAPS-INNOV, a project under the EU's Horizon 2020 programme. It will implement the technology roadmap of the League of Accelerator-Based Light Sources (LEAPS) and enhance partnership with industry by offering joint technological developments and advanced research capabilities with LEAPS members for industry.



A kick-off meeting in April marked the official start of LEAPS-INNOV.

LEAPS is a European research consortium established in 2017 to foster synergies across Europe's accelerator-based light source facilities. In the context of open innovation, the LEAPS-INNOV pilot project will contribute to solving key technological challenges for the next generation of photon sources, the upcoming diffraction-limited storage rings and the still novel X-ray free-electron lasers.

The project's work packages encompass advanced accelerator technology, improvement of European capabilities for production of high-performance X-ray mirrors and diffraction gratings as well as efficient sample delivery systems with higher spatial and temporal resolution. All of these are required to generate and maintain nanometre-focused beams for users of synchrotron radiation and free-electron lasers.

## May

### DESY und KEK sign new cooperation agreement

The directors of DESY and the High Energy Accelerator Research Organization KEK in Tsukuba, Japan, signed a new framework agreement to put their traditionally close cooperation on a new basis. DESY and KEK have many overlapping research topics, and the directorates and scientific heads of both centres meet regularly to exchange information on existing and future projects and develop new ideas.

In addition to cooperating in particle physics, both centres also operate photon sources and are very active in the development of future accelerators. Alongside scientific computing and the development of high-performance detectors, research into superconducting and compact particle accelerators is to be a major focus of the joint efforts.

### DESY building is pilot project for Hamburg's green facades

On the campus in Hamburg, DESY and the Hamburg environmental authority launched one of the city's largest projects for greening buildings. Around 4600 m<sup>2</sup> of the facade and flat roof of DESY's Building 36 – an experimental hall of the Accelerator Division – will be planted with around 25 000 grasses, perennials and climbing shrubs. The Hamburg environmental authority is funding the project with a total of 410 000 euros, with DESY contributing a similar amount.

The project is part of the programme "Green DESY" with which DESY is contributing to environmentally friendly urban development. In the coming years, DESY plans to increasingly use roof and facade areas for greening and solar energy at both sites in Hamburg and Zeuthen.



This is what DESY's Building 36 will look like in a few years' time.



## June

### Helmholtz Photon Science Roadmap presented

Three research centres of the Helmholtz Association – DESY, HZB and HZDR – have jointly developed a national strategy for upgrading the accelerator-based light sources they operate in Hamburg, Berlin and Dresden. The improvements proposed in the strategy will provide unique research opportunities in Germany in areas such as high-tech materials, environmental issues, energy sources, information technology, medicine and cultural heritage.

At DESY, the strategy includes the upgrade of the synchrotron radiation source PETRA III to the worldwide unique 3D X-ray microscope PETRA IV. Another measure is the modernisation of the FLASH free-electron laser facility to FLASH2020+, which will be world-leading among free-electron lasers for soft X-rays and terahertz radiation. The strategy paper was presented on 28 June at the Helmholtz Symposium “Research Infrastructures of the Future” as part of the Helmholtz Roadmap.



The national strategy for the upgrading of accelerator-based light sources was presented in June.

## July

### DESY welcomes summer students from 25 nations

Almost 80 students of physics and related sciences took part in DESY’s summer student programme 2021. The majority of them participated remotely via online tools due to the COVID-19 pandemic, while seven students were integrated in the research groups on site in Hamburg.

The DESY summer student programme has been running for several decades and is one of the largest of its kind in Europe, offering insights into particle physics, photon science, accelerator technology, computing and astroparticle physics. In 2021, for the first time, most of it took place online – a new experience for all involved. The programme included a series of online lectures on research at DESY, which was available to everyone and was followed by several hundred participants from all over the world.

## August

### Table-top electron camera catches ultrafast dynamics of matter

Scientists at DESY have built a compact electron camera that can capture the inner, ultrafast dynamics of matter. Their ultrafast electron diffractometer fires short bunches of electrons at a sample to take snapshots of its inner structure and is the first to use terahertz radiation for pulse compression. The development team from the Center for Free-Electron Laser Science (CFEL) validated the diffractometer by investigating a silicon sample.

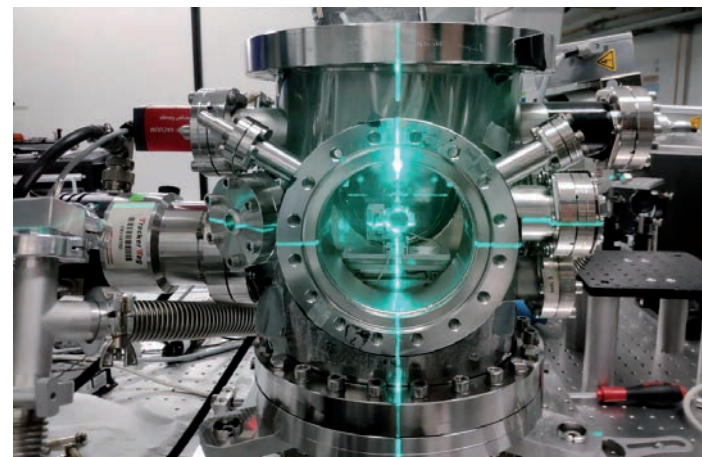

The terahertz ultrafast electron diffractometer fits on a lab table. It is adjusted with the help of an optical laser (green).

Electron diffraction is a way to investigate the inner structure of matter: When the electrons hit or traverse a solid sample, they are deflected by the electrons in the solid’s inner lattice. From this diffraction pattern, the structure of the internal lattice can be calculated. To detect dynamic changes in this structure, the electron bunches must be sufficiently short and intense. Typically, ultrafast electron diffraction uses bunch lengths of some 100 fs.

Such short, high-quality electron bunches can be routinely produced by state-of-the-art particle accelerators. However, these are often large and bulky, partly due to the gigahertz radio frequency radiation used to power them. The DESY team used terahertz radiation instead with roughly a 100 times shorter wavelengths, meaning that the accelerator components can be a 100 times smaller too.

For their proof-of-principle study, the team fired electron bunches at a silicon crystal heated by a short laser pulse. The bunches were about 180 fs long and clearly revealed how the crystal lattice of the sample expanded within a picosecond after the laser hit the crystal. The behaviour of silicon under these circumstances is well known, and the measurements fitted the expectation perfectly, validating the device. The team estimated that, in an optimised setup, the electron bunches could be compressed to significantly less than 100 fs, allowing even faster snapshots.

On top of its reduced size, the terahertz electron diffractometer has another advantage. The system is perfectly synchronised, as it uses just one laser for all steps: generating, manipulating, measuring and compressing the electron bunches, producing the terahertz radiation and heating the sample. In this kind of ultrafast experiment, synchronisation is key. If both the start of the experiment and the electron bunch and its manipulation are triggered by the same laser, synchronisation is intrinsically given.

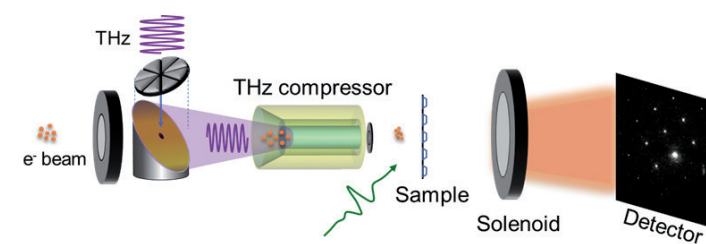

Schematic setup of the terahertz ultrafast electron diffractometer

In a next step, the scientists plan to increase the energy of the electrons so they can investigate thicker samples. With the prototype setup, the silicon sample had to be sliced to a thickness of 35 nm. Adding another acceleration stage could give the electrons enough energy to penetrate 30 times thicker samples with a thickness of up to 1 µm. For even thicker samples, X-rays are normally used. While X-ray diffraction is a well established and very successful technique, electrons usually do not damage the sample as quickly as X-rays do, as the energy deposited is much lower when using electrons. This could prove useful when investigating delicate materials.

### DESY signs Diversity Charter

By signing the Diversity Charter (“Charta der Vielfalt”), DESY became part of Germany’s largest diversity network. The Diversity Charter is an initiative that aims to promote diversity in companies and institutions. Since its inception in 2006, it has been signed by over 4500 organisations with a total of more than 14.6 million employees.

DESY stands for open-mindedness and tolerance. It is committed to a diverse, prejudice-free working environment and appreciates all employees regardless of their gender and gender identity, nationality, ethnic origin, religion or belief, disability, age, sexual orientation and identity.





**Hamburg's Science Senator and Innovation Senator visit DESY**

Hamburg's Senator for Science Katharina Fegebank and Senator for Economy and Innovation Michael Westhagemann visited DESY to learn more about the centre's innovation activities. The focus was on the cooperation between industry and science and on plasma acceleration technology, which has a high potential for innovations in medicine and materials research.



Hamburg Science Senator Katharina Fegebank and Hamburg Innovation Senator Michael Westhagemann with DESY Director Helmut Dosch (far left) and DESY's Chief Technology Officer Arik Willner (far right)

Several groups at DESY are working on making the complex technology of laser plasma acceleration more flexible to use, for example for investigating materials and active substances with atomic resolution. The aim is to shrink football-field-long accelerator facilities to about the size of a van and make their operation easier and more automated. The compact accelerators are to be developed specifically for various applications in science and industry and, in the long term, will complement large-scale research facilities such as DESY's synchrotron radiation source PETRA III.

**Science cooperation with China**

A joint two-year project of DESY and the German Institute for Global and Area Studies (GIGA) is to draw up guidelines for scientific cooperation with China. The WIKOOP-INFRA project, funded by the German Federal Ministry of Education and Research (BMBF), focuses on cooperation at large-scale research facilities, such as particle accelerators and X-ray, laser and neutron sources, in China and Europe.

Current global challenges, such as the COVID-19 pandemic and climate change, demonstrate that scientific cooperation with China is more important than ever for Germany and many EU countries. However, amid concerns about patent and copyright infringement, one-sided technology transfer, scientific misconduct and lack of access to important research infrastructure and data, the framework for such collaborations is anything but straightforward. There have also been reports of China exerting increasing political influence on science and of a growing conflation of military and civilian research. Competition between the USA and China for technological leadership is also a potential source of tensions.

So far, no systematic guidance has been available to scientists and research institutions when assessing opportunities for cooperation, nor have there been recommendations as to how to deal with sensitive issues. The WIKOOP-INFRA project (Ensuring safe, transparent and mutually beneficial collaboration with China at analytical research infrastructures) will develop evidence-based guidelines to provide international protagonists, especially from Germany and the EU, with greater orientation and certainty on how to act in the face of sensitive issues when cooperating with China in research at large-scale facilities.



Researchers from China and Europe are collaborating on large-scale facilities, such as the Shanghai Synchrotron Radiation Facility (SSRF).

**Start-up Labs Bahrenfeld opened**

The Start-up Labs Bahrenfeld, a project jointly managed by DESY, Universität Hamburg and the City of Hamburg, were opened on the DESY campus. The innovation centre offers deep-tech start-ups in the fields of physics and biophysics laboratories, workshops, offices and meeting rooms. Demand is high – almost all the premises at the Start-up Labs had been leased by the time they opened. The topics covered by the companies range from synchrotronisation systems to individualised tests for diagnosing cancer.



The Start-up Labs Bahrenfeld, a joint innovation centre of DESY, Universität Hamburg and the City of Hamburg

**Brandenburg's Science Minister visits DESY in Zeuthen**

Brandenburg's Science Minister Manja Schüle visited DESY in Zeuthen to learn about the history and developments of the campus as well as ongoing and planned projects. During a tour of the photoinjector test facility PITZ, the only research particle accelerator in Brandenburg, the minister heard about the current state of research in accelerator development and plans to realise an R&D platform for new forms of cancer therapy, such as *electron FLASH (eFLASH)* and very-high-energy electron (VHEE) radiation therapy and radiation biology.



Brandenburg's Science Minister visits PITZ, the only research particle accelerator in Brandenburg.

**Science on (digital) tap**

At the "Science on tap" event, scientists from DESY and Universität Hamburg talk about their everyday work, usually in bars and pubs. In 2021, the popular talks took place online because of the pandemic – a superspreading event of a different kind. Five videos are available online, offering fascinating insights into various research areas, from particle physics through communication science to virology, and answering all kinds of questions. Whether online or offline – such entertaining knowledge transfer from scientific experts to the interested public is more important than ever.





## September

### Horst Klein Research Award for Peter Schmüser

Together with the Horst Klein Foundation of the Physikalischer Verein Frankfurt, the Working Group on Accelerator Physics of the German Physical Society (DPG) awarded Peter Schmüser the Horst Klein Research Prize 2021 for outstanding scientists in accelerator physics. The long-time DESY researcher and professor emeritus at Universität Hamburg was honoured for his remarkable scientific achievements in the application of superconductivity in accelerator physics.

Peter Schmüser's work opened up new technological territory for the development of superconducting magnets for the proton storage ring of DESY's former electron-proton collider HERA and decisively advanced the development of high-energy ring accelerators for particle physics. The same applies in the field of light sources based on linear accelerators, where he made pioneering contributions to the optimisation and use of superconducting accelerator cavities. This research, which began as part of studies for the linear collider project TESLA, was ultimately of great importance for the success of the European XFEL X-ray laser.

At the award ceremony, the jury particularly emphasised that Peter Schmüser was not only able to implement his ideas with outstanding success, but also communicated them to a large number of young scientists through excellent review articles, textbooks, lectures and contributions at summer schools.



Horst Schmidt-Böcking (right), representative of the Horst Klein Foundation of the University of Frankfurt and the Physikalischer Verein Frankfurt, congratulates Peter Schmüser (left) on the award.

### DESY and HAW Hamburg agree on new cooperative venture KAI

DESY and the Hamburg University of Applied Sciences (HAW Hamburg) agreed on a new strategic Cooperation for Application and Innovation (KAI). The cooperative venture focuses on dual education programmes and teaching, research and development as well as innovation, technology and knowledge transfer. KAI will strengthen the joint training of urgently needed highly qualified engineers and scientists and help to shape Hamburg's structural transformation into a science and innovation metropolis in northern Germany, through applied research and the development of sustainable and digital technologies.

The areas of cooperation range from real-time control technologies for accelerator facilities, through visual simulation and robotics, efficient energy systems, scientific computing, intelligent sensor systems, spectroscopy and data processing, embedded electronics and electronics development, all the way to scientific illustration.



From left: DESY Director Helmut Dosch, Hamburg's Science Senator Katharina Fegebank and HAW Hamburg President Micha Teuscher at the launch of the cooperation KAI

### Lucas Schaper takes over as head of FLASH2020+

FLASH2020+ is DESY's project to upgrade its FLASH free-electron laser in order to increase the flexibility of the facility and enable the production of even brighter radiation for users. Since July 2020, the project had been led by seeding expert Enrico Allaria, who decided to return to his former workplace, the FERMI free-electron laser in Trieste, Italy, for personal reasons. In September 2021, he handed over the project management to Lucas Schaper, who had worked together with him since the start of the project.



Lucas Schaper (left) takes over the management of the FLASH2020+ project from Enrico Allaria (right).

Under Enrico Allaria's leadership, the team established the conceptual approaches and framework to manage and keep the timeline of this important, time-critical project. The new project leader, Lucas Schaper, had been working at FLASH since 2011, heading the development of the new externally seeded FLASH1 beamline since April 2020. He took over the project management shortly before the start of the upgrade of the FLASH accelerator in a dedicated nine-month shutdown from November 2021 on. A second shutdown is planned for 2024 to install new undulators, lasers and the external seeding system to enhance the brightness of the photon source.

## October

### Karl Heinz Beckurts Prize awarded at DESY

Vasilis Ntziachristos, head of the Institute of Biological and Medical Imaging (IBMI) at Helmholtz Zentrum München and a professor at Technische Universität München, was awarded the 2021 Karl Heinz Beckurts Prize for his pioneering work in biomedical imaging, in particular the development of multispectral optoacoustic tomography (MSOT). For the first time, the Karl Heinz Beckurts Foundation also awarded Medals of Honour, to Uğur Şahin and Özlem Türeci (BioNTech) and Ingmar Hoerr (formerly CureVac) for their outstanding achievements in mRNA vaccine development.

The Karl Heinz Beckurts Foundation was established by the Helmholtz Association, together with Siemens AG, in memory of the German physicist and manager Karl Heinz Beckurts. The presentation of the award took place at DESY.



Award ceremony of the Karl Heinz Beckurts Prize (from left): Roland Busch (Chairman of the Managing Board of Siemens AG and member of the Beckurts Foundation Board), Ingmar Hoerr (formerly CureVac), awardee Vasilis Ntziachristos, Christian Stegmann (DESY Director in charge of Astroparticle Physics and Chairman of the Beckurts Foundation Board), on screen: Uğur Şahin and Özlem Türeci (BioNTech)



## November

### Jens Osterhoff receives Bjørn H. Wiik Prize 2021

DESY physicist Jens Osterhoff was awarded the Bjørn H. Wiik Prize 2021 in recognition of his outstanding contributions to the field of plasma acceleration. Under his leadership, a team at DESY is conducting research into plasma accelerators – a new generation of accelerators that are much more compact and less expensive than conventional facilities, yet extremely powerful.

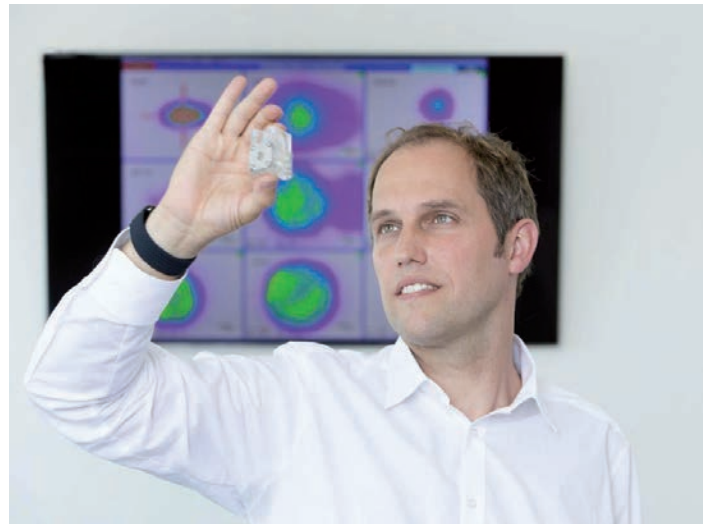

Bjørn H. Wiik prizewinner Jens Osterhoff with a plasma cell

For example, at the FLASHForward experiment at DESY's FLASH free-electron laser facility, Osterhoff and his team succeeded in accelerating particle bunches with previously unattained efficiency while maintaining a very small spread of the energy distribution within the accelerated particle bunch.

Jens Osterhoff has been conducting research at DESY since 2010, first in particle physics and since 2019 in accelerator physics. The Bjørn H. Wiik Prize is DESY's most important science award. It is presented on the DESY Science Day in memory of the former Chairman of the DESY Board of Directors Bjørn H. Wiik, who died in 1999.

### First-class DESY trainees

Two DESY apprentices were honoured by the Hamburg Chamber of Commerce as best trainees in their fields: Lena Anton in industrial mechanics and Raphaela Renner in electronics for devices and systems. DESY was again honoured for outstanding achievements in dual training.

Lena Anton, a newly qualified industrial mechanic, has known DESY since her school days, when she came here to conduct vacuum experiments in the school lab. After her apprenticeship, she joined the Superconducting Accelerator Technology (MSL) group in the Accelerator Division, where she is in charge of quality testing. She would like to stay at DESY in the long term and train young people herself.

Raphaela Renner, an electronics technician for devices and systems, would also like to stay at DESY. She first came to the research centre for the Open Day in 2015 and, already back then, found it very exciting. Since completing her training, she has been working in the Electronics Service Centre.

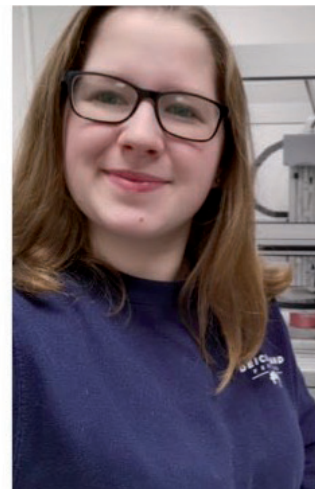

Raphaela Renner and Lena Anton are among Hamburg's best trainees.

### DESY Science Day 2021

The DESY Science Day 2021 took place in November under strict hygiene and distancing rules in the auditorium and was broadcast online via livestream at the same time. Presentations covered research news from the past months and promising developments for the coming years. In addition, tributes were paid to the lifetime achievements of DESY employees.



The research highlights were presented by four scientists from DESY's four divisions, among them Shan Liu from the Accelerator Division.

Albrecht Wagner and Jochen Schneider – two outstanding personalities who have had a significant impact on the development of DESY – were awarded the DESY Golden Pin of Honour. Wagner was DESY Research Director from 1991 to 1999 and Chairman of the DESY Board of Directors from 1999 to 2009. Schneider was DESY Director in charge of Photon Science from 2000 to 2007. Both were pioneers in a special time after the sudden death of DESY Director Bjørn H. Wiik in 1999. They managed to keep the research centre thriving with a sustainable future – and the results of their efforts are still visible today.



DESY Director Helmut Dosch (centre) congratulates Albrecht Wagner (left) and Jochen Schneider at the presentation of the Golden Pins of Honour.

## December

### ALPS magnets cooled to $-269^{\circ}\text{C}$

The superconducting magnets used in the ALPS II particle physics experiment at DESY were cooled to their operating temperature of  $-269^{\circ}\text{C}$  (4.2 K), marking the completion of an important step in the experiment's commissioning. After an interruption of more than 14 years, helium thus once again flowed through the tunnel of DESY's former electron-proton collider HERA, which houses the experiment.



In late 2020, the last of the superconducting ALPS magnets were installed in the tunnel. Meanwhile, the entire chain has been cooled to  $-269^{\circ}\text{C}$  with liquid helium.

The aim of the "light-shining-through-a-wall" experiment ALPS (Any Light Particle Search) is to detect extremely light particles that could make up dark matter. The international team uses 24 recycled superconducting HERA dipole magnets, laser beams and an extremely sensitive detector to search for axion-like particles.

After the last of the magnets was installed in the tunnel, the superconducting cables, cryogenic pipes and vacuum insulation were connected, and the modules were linked to the power supply and the cryogenic system to be filled with liquid helium. After the mandatory pressure test, the helium valves were opened on 20 November. On 15 December, the stable state of  $-269^{\circ}\text{C}$  was reached.

The mode of operation of the cryogenic cooling is the same as for HERA: The magnetic coils are completely surrounded by single-phase supercritical helium, which is kept cold by controlled evaporation of helium.

Initial tests showed that the optical system of the experiment remained stable throughout the cooling. The next step was to test how the superconducting magnets behave when some 5600 A of current flow through their coils as they generate the strong magnetic field. Data taking of ALPS II is scheduled to begin in 2022.



# Keeping our facilities at the forefront

Transport of one of the APPLE-X undulators in the European XFEL undulator tunnel (more info: see p. 32).

Picture: Suren Karabekyan, European XFEL

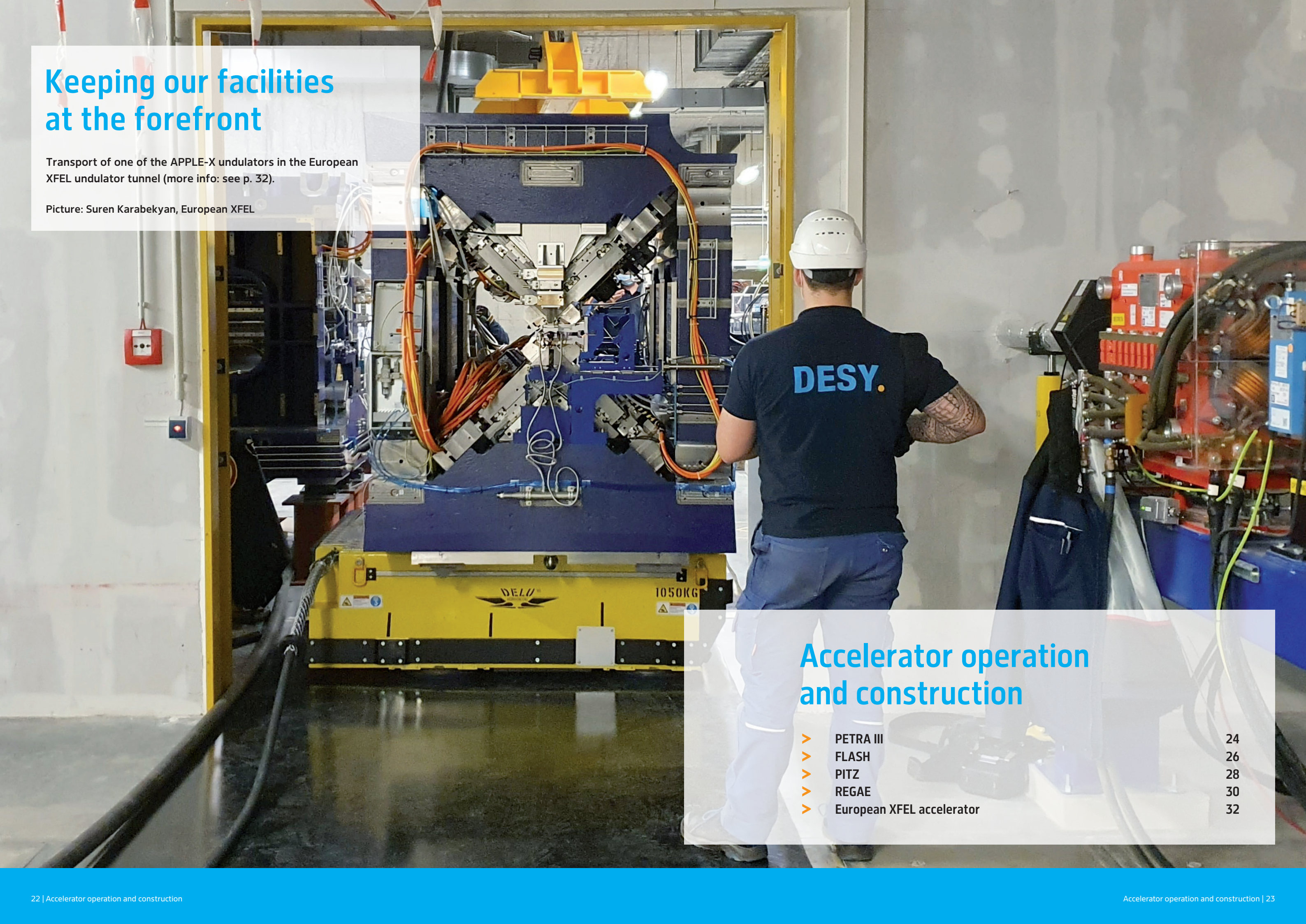

## Accelerator operation and construction

➤	PETRA III	24
➤	FLASH	26
➤	PITZ	28
➤	REGAE	30
➤	European XFEL accelerator	32



In 2021, the operation of DESY's synchrotron radiation source PETRA III faced several challenges to ensure good availability for the user community. The operation schedule had to be adapted due to the COVID-19 pandemic. At the end of February, beam operation resumed after a shutdown period that had started on 21 December 2020. Eventually, 4632 h of beamtime were scheduled for the user run, which were delivered with an availability of 97.3%. During the winter and summer shutdown periods, a new dipole beamline (P66) was successfully installed close to the Paul P. Ewald experimental hall, marking the final milestone of the PETRA III extension project.

### Installation of a new dipole beamline

During the winter shutdown 2020/21 and the summer shutdown 2021, a new beamline (P66) was installed close to the "Paul P. Ewald" experimental hall in the north-east of the PETRA ring (Fig. 1). P66 is the first dipole beamline of the PETRA III facility, dedicated to vacuum-ultraviolet (VUV)

luminescence and reflection spectroscopy experiments. Thanks to essential efforts of all the technical groups, all shutdown activities could be finished on schedule. First light from the dipole was directed to the absorber of the beamline on 30 July 2021. The experimental hutch is located in Building 47k on top of the PETRA III tunnel

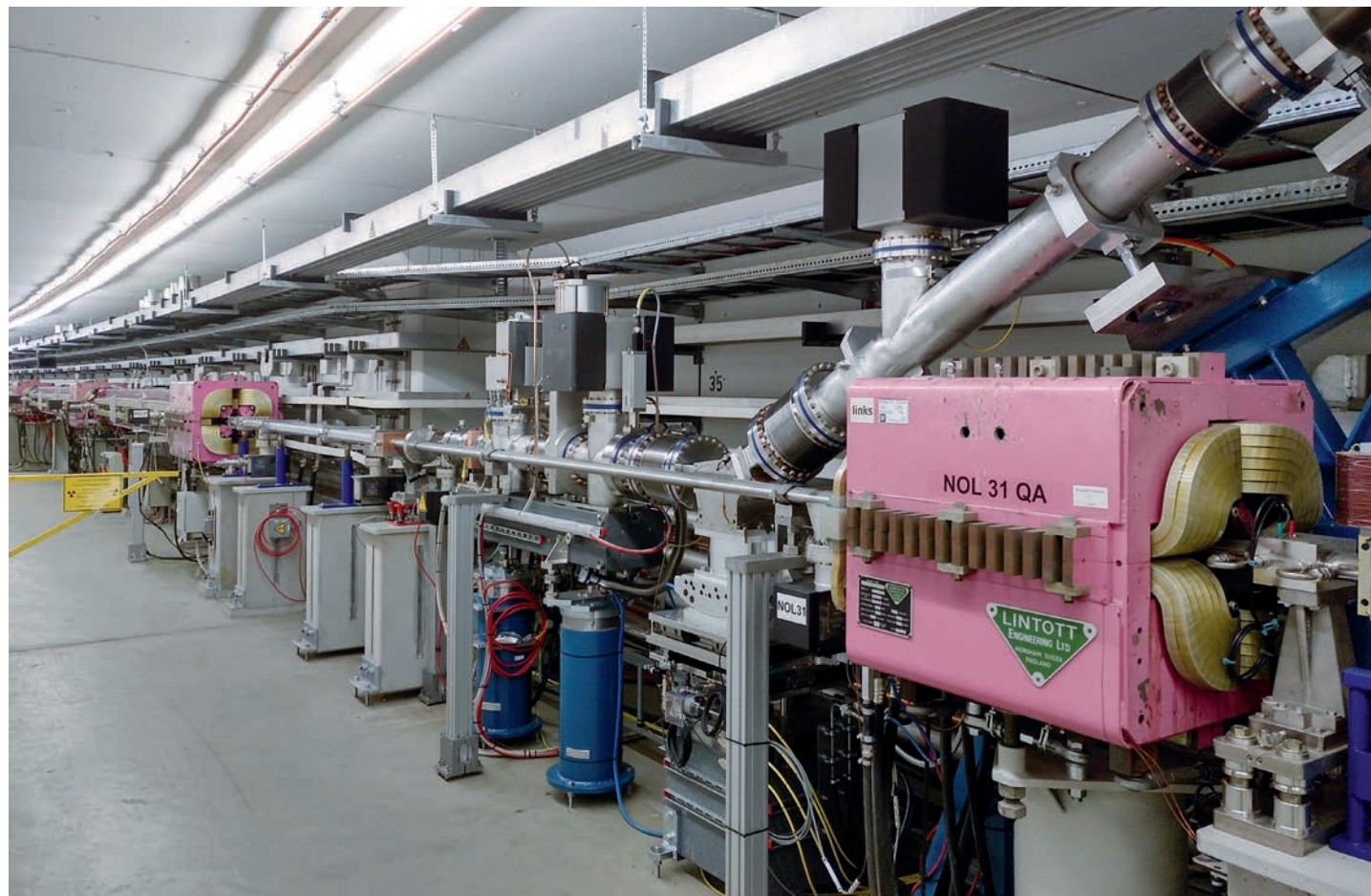

Figure 1  
Dipole magnet and front-end components of the new dipole beamline P66 in the PETRA III tunnel

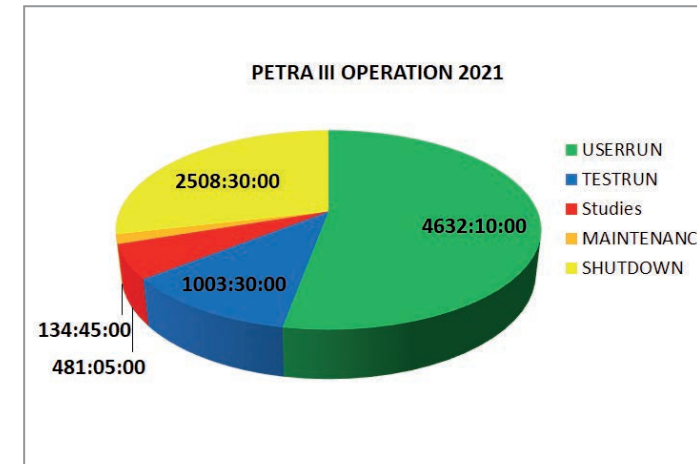

Figure 2  
Distribution of the different machine states in 2021

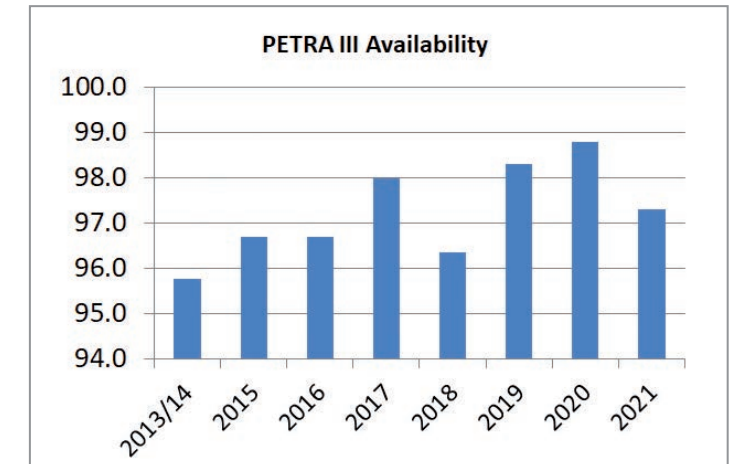

Figure 3  
Long-time development of the availability of PETRA III during user runs

between the FLASH experimental hall "Kai Siegbahn" and the PETRA III experimental hall "Max von Laue". The synchrotron radiation from the dipole is guided by a mirror upwards from the accelerator to the experimental hutch.

### User operation

Regular user operation resumed on 15 March 2021 after a short commissioning period of about two weeks. Originally, 4824 h of beamtime had been planned for the user run in 2021. However, due to the COVID-19 pandemic, the plan was revised in favour of a home office period at the beginning of January, resulting in a delayed start of activities in the winter shutdown. Fortunately, any further impact of the pandemic on the installation work and user operation could be mitigated by implementing additional safety measures. As a result, good resilience of PETRA III user operation was again achieved despite the challenging conditions in this second year of the pandemic.

Eventually, 4632 h of beamtime were scheduled for the user run, which were delivered with an overall good availability of 97.3%. Necessary maintenance was done in five dedicated service periods distributed over the year and additionally during the three-week-long summer shutdown. On Wednesdays, user operation was interrupted by weekly regular maintenance or machine development activities as well as test runs for 24 h in total. The distribution of the different machine states in 2021 is shown in Fig. 2. In addition to the 4632 h scheduled for the user run, 1003 h of test run time could be planned for the users. During user runs, the storage ring was operated in two distinct modes characterised by their bunch spacing of either 16 ns

(480 bunches) or 192 ns (40 bunches). In 2021, 48% of the user time was allocated to the 480-bunch mode and 52% to the 40-bunch mode.

In 2021, the weekly availability reached 100% for several weeks of the year, while in one particular week only 88% was achieved. Due to several failures of subsystems at the end of the user run, the average availability was only 97.3%, which is a good achievement, but significantly lower than in the previous years. The long-time development of the availability of PETRA III during user runs is shown in Fig. 3. The average mean time between failures (MTBF) at the end of 2021 was 53 h, and the mean time to recover (MTTR) was 1.5 h. The downtime in 2021 was dominated by a few events that caused longer downtime periods: a water leak at a magnet in the injector, a failure in the multi-bunch feedback electronics and two power black-outs. The root cause analysis of all faults during the user run was assisted by an internal review process to monitor the availability of PETRA III, hopefully leading to an improved performance in 2022. All these plans will only be realised with an essential effort from all the technical groups involved.

### Plans for the next operation period

The winter shutdown 2021/22 will be dedicated to maintenance work, while the plan for the summer shutdown 2022 includes preparations for the installation of a new single-cell cavity and new beam current monitors to support the technical design for the planned upgrade of PETRA III to PETRA IV.

Contact: Rainer Wanzenberg, [rainer.wanzenberg@desy.de](mailto:rainer.wanzenberg@desy.de)  
Michael Bieler, [michael.bieler@desy.de](mailto:michael.bieler@desy.de)



# FLASH

High-performance photon and accelerator experiments in difficult times

DESY's FLASH free-electron laser (FEL) facility features two undulator beamlines, FLASH1 and FLASH2, operated in parallel as a tandem. The FLASH3 beamline is used by the FLASHForward plasma wakefield acceleration experiment. In 2021, the FLASH linear accelerator delivered beam for a total of 6716 h for user experiments, FEL studies and developments, photon beamline and experimental station R&D as well as accelerator-related experiments. As in 2020, due to the COVID-19 pandemic, not all users whose experiments were selected by the review panel were actually able to come on site; some managed to perform their experiment remotely with the strong support of DESY staff operating the experimental stations. The availability of FLASH for user experiments stabilised at 97% for both beamlines.

## Operation

In 2021, the pandemic situation still substantially hampered scientific user operation and accelerator R&D efforts at FLASH. Of the 31 photon experiments originally planned, eight already had to be cancelled in the first half of 2021. This was mostly due to the extended lockdown in Germany in early 2021 and to travel or quarantine restrictions for users from abroad. Of the remaining 23 experiments, 19 were conducted with extensive support from FLASH staff. Only a few external users were allowed to come on site, but we all learned how to make the best use of video conferencing tools and remote access to the data. Unfortunately, the reduced number of operable experiments also led to less potential overlap in parameters that would have allowed more parallel operation of FLASH1 and FLASH2. Thus, experiments could be matched for parallel operation in both experimental halls only in about 20% of cases.

Usually, the parallel user operation quota would be around 30–40%, yielding substantially more beamtime for users.

Accelerator R&D efforts concentrated on the preparation of the seeding scheme for the FLASH2020+ upgrade and on FLASHForward. In photon beamline R&D, a lot of work went into upgrading the photon beamlines and experimental stations. One example was the start of setup of a new beamline (FL23), which has a time-delay-compensating monochromator as a key element. A substantial upgrade of the pump-probe lasers in FLASH1 was also begun. The old burst mode pump-probe laser system, which had been in operation for many years, was disassembled to make space for next-generation lasers. A highlight of new scientific opportunities was the first user experiment combining the FLASH2 self-amplified spontaneous emission (SASE) pulses with a high-harmonic generation (HHG) laser source

at Beamline FL26. The SASE pump – HHG probe experiment was successfully conducted at the Reaction Microscope (REMI) experimental station.

## Operation statistics

Despite the COVID-19 pandemic and shutdowns to substantially upgrade the facility, the FLASH accelerator delivered beam for 6716 h. In the planning in “normal” years, 7500 h would be foreseen for operation, 4500 h of which are planned for user experiments, including setup and tuning according to the individual needs of the experiments. Another 2250 h of the beamtime are reserved for studies related to the progress of and R&D for FEL operation and photon beamlines, including experimental stations, as well as for preparatory experiments for the FLASH2020+ project. A further 750 h are reserved for general accelerator R&D.

In 2021, 3857 h (57%) of the beamtime could be provided to user experiments, partially in parallel operation of FLASH1 and FLASH2. In addition, FLASH provided 2393 h (36%) of beamtime for FEL-related studies and another 466 h (7%) for general accelerator R&D, mostly for FLASH-Forward (Fig. 1). Additional beamtime for FLASHForward could be provided during user experiments at FLASH1. The beamtime for users includes the time required for setup and tuning of the experiments prior to the handover of the beam. Every experiment has its own wish list of photon properties and its own demands regarding high-quality and stable beams. The FLASH team has worked hard to streamline all the related procedures. As a result, the setup and tuning time could be pushed down to a record low of 8 to 10% of the user beamtime.

After the handover of the beam to experiments, major retuning is rarely required. In 2021, the availability of the facility stabilised at 97% overall. The downtime during user experiments was 3.2% for FLASH1 and 2.6% for FLASH2. The slight increase compared to 2020 was mainly due to

frequent power glitches in August, failures of aged hardware of control systems and one singular event involving a radio frequency (RF) station. Measures have been taken to avoid these failures in the future.

## Extending the capabilities of FLASH

The FLASH2020+ project aims to provide greatly improved experimental capabilities. It thus encompasses many major changes and upgrades to almost all sections of the accelerator, the undulators, the photon beamlines and the photon diagnostics, including substantial work in the experimental halls.

The FLASH accelerator team, together with the FLASH2020+ team and colleagues from the Accelerator and Photon Science support groups, are working hard to successfully realise major refurbishments and upgrades to complete Phase 0 of the FLASH2020+ project in a nine-month shutdown that began in mid-November 2021. A key feature of the upgrade is the increase in electron beam energy to 1.35 GeV, which will allow FLASH to lase at about 20% shorter wavelengths than before, thus reaching deeper into the water window – the wavelength region in which water is transparent to soft X-rays. The energy upgrade is realised by replacing two accelerator modules with two improved ones with much better performance (Fig. 2). Other important upgrade items are the installation of a laser heater system and the modification of bunch compressors. FLASH2 will be equipped with a variable-polarisation third-harmonic afterburner undulator of APPLE III type, optimised to provide photon energies around the L-edges of iron, chromium and nickel, thus paving the way for studies in ultrafast magnetisation dynamics.

The FLASH team is very grateful to the DESY support staff for making an exceptional machine performance possible.

Contact: Siegfried Schreiber, [siegfried.schreiber@desy.de](mailto:siegfried.schreiber@desy.de)

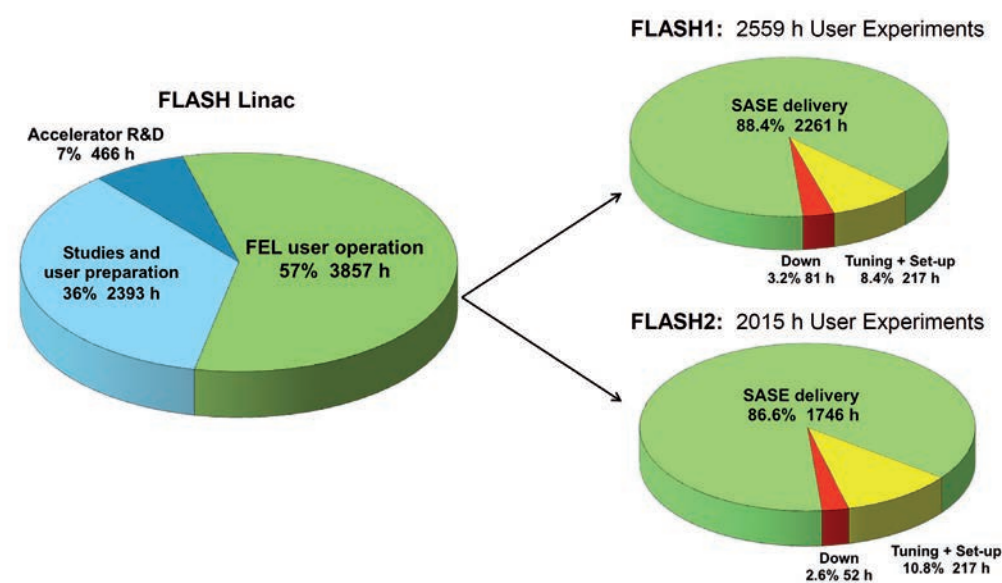

Figure 1  
FLASH operation statistics in 2021. Despite restrictions due to the pandemic, a total of 6716 h of accelerator beamtime could be delivered. Of these, 3857 h were devoted to user experiments. (Preparation, setup and tuning of experiments prior to handover is included in the yellow-coloured slice.)



Figure 2  
Shutdown work in the FLASH injector section. Two accelerator modules (left) are removed (right) to be replaced by upgraded modules.



In 2021, research at the PITZ photoinjector test facility at DESY in Zeuthen focused on high-brightness photoinjector optimisation and the development of applications, such as the realisation of a proof-of-principle THz self-amplified spontaneous emission (SASE) free-electron laser (FEL). Besides these activities, a proposal for future use of PITZ as an R&D platform for *electron FLASH (eFLASH)* and very-high-energy electron (VHEE) radiation therapy and radiation biology was submitted.

### High-brightness beam characterisation at PITZ

In 2021, the PITZ group continued to study the working points of the injector of the European XFEL X-ray laser at electron bunch charges of 100, 250 and 500 pC, respectively. The beam emittance at 100 pC was optimised, resulting in a 4D brightness 30 to 40% higher than at 250 and 500 pC. In addition to the transverse brightness, the group also studied the longitudinal brightness, especially the slice energy spread, at 250 pC and 500 pC. A new slit-based method was developed to enhance the measurement accuracy of the slice energy spread at the low-energy ( $\approx 20$  MeV) photoinjector of PITZ. The slice energy spread measured at PITZ at 250 pC (Fig. 1) is more than a factor of 3 lower than that measured at the European XFEL injector, indicating a growth mechanism of the slice energy spread in the high-energy injector of the European XFEL.

### Gun development

The radio frequency (RF) electron source type Gun 5 is the new, optimised type of L-band long-pulse (1 ms) RF gun aimed at delivering more electron bunches per second to users at FLASH and the European XFEL. One of its features is an RF field antenna inside the cavity for direct gun field measurement in order to allow for better regulation of the RF field stability over the pulse train. Gun 5.1, the first electron gun of the new type, was installed at PITZ in late summer 2021, and RF conditioning of the cavity started on 18 October. Conditioning progress was quick at the beginning, but is more time-consuming for the extraordinarily long RF pulse length. First photoelectrons were produced in December. The RF probe was taken into operation, and the measurement programme with Gun 5.1 will start with detailed studies of RF field measurement and regulation possibilities in early 2022.

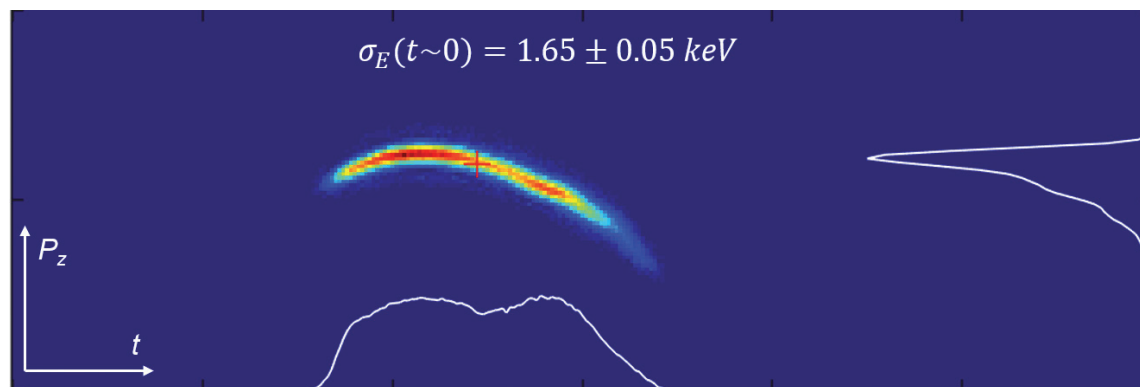

**Figure 1**  
Slice energy spread measurements at PITZ show values much lower than those measured at higher-energy injectors (e.g. European XFEL, SwissFEL).

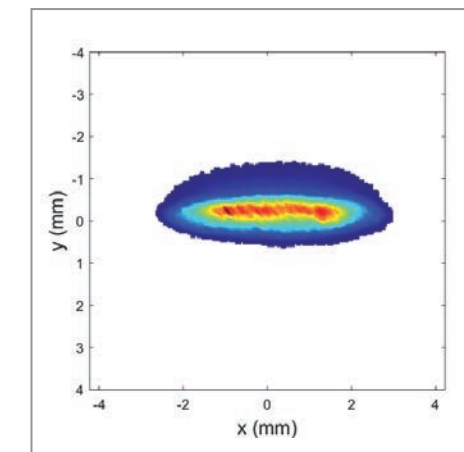
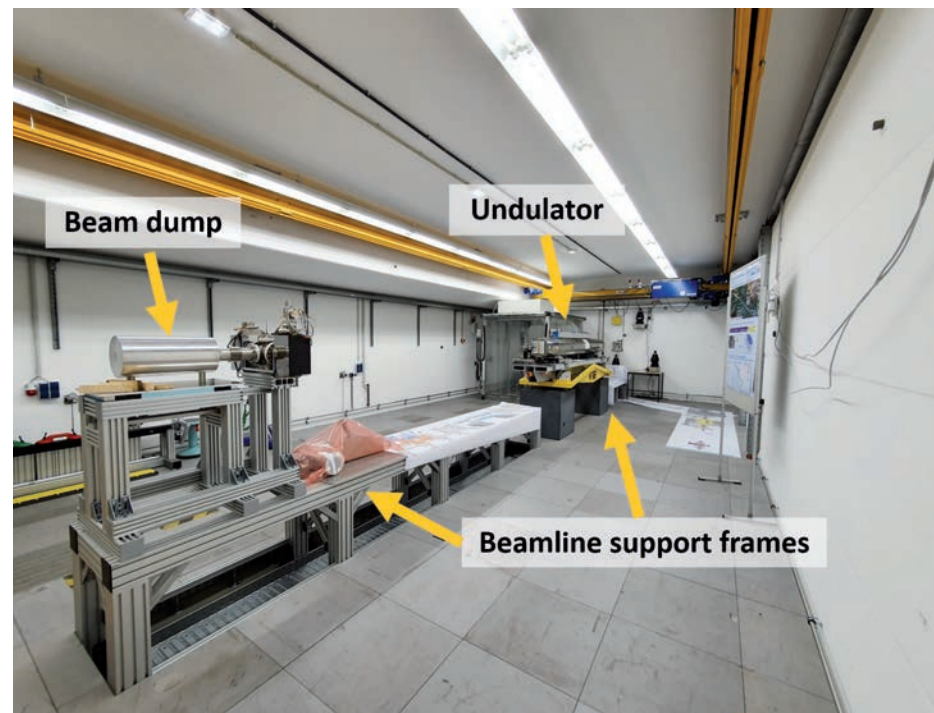

**Figure 2**  
Left: THz installations in the PITZ tunnel extension. Right: 4 nC beam distribution measured at the virtual undulator entrance.

### Photocathode R&D

Multi-alkali photocathodes, which are sensitive in the green wavelength range, can potentially reduce cathode laser complexity and enhance beam brightness of the European XFEL photoinjectors. A collaboration between INFN LASA in Milano, Italy, and DESY delivered the first cathode box with three “green” cathodes to DESY in Zeuthen for testing in the PITZ gun. A two-week beam study revealed its performance in terms of lifetime, quantum efficiency, thermal emittance and dark current. Its performance at the time was still far from the required user operation standards, but its thermal emittance was demonstrated to be 30 to 40% lower than for caesium telluride ( $\text{Cs}_2\text{Te}$ ) cathodes at gradients up to 30 MV/m, as used for continuous-wave (CW) guns. This improved the beam brightness at 100 pC by 60%. The findings during operation at PITZ point out important directions for further cathode recipe improvements, which are ongoing at INFN LASA.

### A THz source for the European XFEL

In an extension of the PITZ tunnel, the group is setting up a prototype of an accelerator-based high-power, high-repetition-rate THz source for user operation at the European XFEL. In 2021, an LCLS-I undulator was installed in the tunnel extension and first beamline components were placed in their frames (Fig. 2, left). Beamline modifications in the main PITZ tunnel are ongoing. The operation permission for the extended facility is expected in spring 2022, and both tunnels can then be connected. After completion

of the beamline installations, the first electron beam through the undulator could be delivered in early summer 2022. Simulations and experimental studies for characterising the electron beams for THz generation continued in parallel to the installation work. Since the high-charge electron beam transport through the undulator is challenging, an experimental procedure for electron beam matching into the undulator was developed and tested using the current PITZ beamline while emulating the undulator entrance with an existing screen station (Fig. 2, right).

### FLASHlab@PITZ

Work is currently under way to set up an R&D platform for *electron FLASH (eFLASH)* and very-high-energy electron (VHEE) radiation therapy and radiation biology (FLASHlab@PITZ). With its extremely flexible beam parameters and beam manipulation capabilities, PITZ can cover the current parameter range of successfully demonstrated *eFLASH* effects and extend it towards yet unexplored and unexploited short treatment times and high dose rates, which show much better sparing of healthy tissue than conventional radiation therapy. Although external funding for realising the full project is not yet settled, beam dynamics simulations for a dedicated R&D beamline to be installed in the PITZ tunnel extension and Monte Carlo simulations for estimating dose distributions in phantoms have begun.

Contact: Anne Oppelt, [anne.oppelt@desy.de](mailto:anne.oppelt@desy.de)



# REGAE

## First diffraction experiments at 50 Hz repetition rate

Experiments at DESY's ultrafast electron diffraction (UED) facility REGAE were previously limited to a repetition rate of 12.5 Hz due to magnetic interference from the nearby DESY II synchrotron, which changes its magnetic fields with a frequency of 12.5 Hz. Thanks to the introduction of a compensation system, it is now possible to perform experiments at a repetition rate of 50 Hz. High-quality powder diffraction patterns recorded at 50 Hz using the integrating Jungfrau 1M detector highlight the potential of REGAE for time-resolved pump-probe diffraction experiments with a time resolution in the single-digit femtosecond range.

### Upgrade to 50 Hz

The operation of REGAE was limited in the past by the nearby DESY II synchrotron, which ramps up the energy of injected particles with a 12.5 Hz cycle. Magnetic fields oscillating with this frequency are captured by the armouring of the surrounding building and leak out into the REGAE accelerator tunnel. Therefore, REGAE had to operate synchronously with DESY II at 12.5 Hz, so that every electron bunch in REGAE was affected by the same

field components from DESY II. At 50 Hz, the transverse beam position was not constant, but showed a fourfold pattern in accordance with the different phases at which the magnetic field was sampled. Previous attempts to mitigate this problem at the source, i.e. the DESY II synchrotron, by rerouting cables or installing magnetic shielding plates were not successful. Instead, an active compensation system was installed in 2021. The system is based on two orthogonal Helmholtz coils encompassing

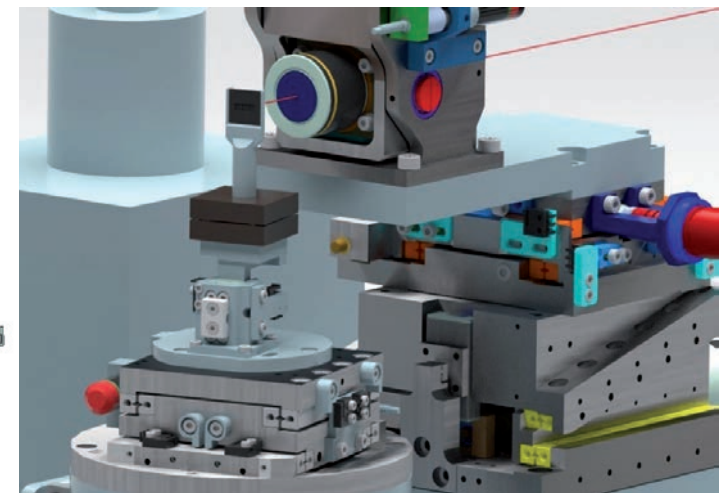
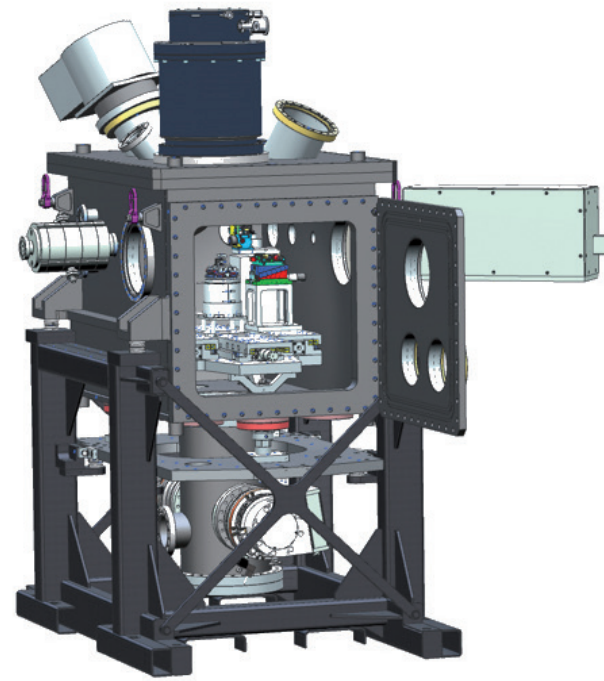

Figure 2

Left: CAD drawing of the new experimental chamber for REGAE, which will allow easy change between setups for diffraction experiments with solid-state samples and liquids. Right: CAD drawing of the high-precision Roadrunner goniometer mounted in the experimental chamber together with the UHV-compatible high-resolution on-axis microscope for simultaneous sample visualisation with visible light and the option of on-axis laser excitation of the sample. The electron beam incident on the sample (black square) is highlighted in red.

the complete facility, a high-precision field sensor and an electronic feedback system.

### Powder diffraction with MeV electrons

To test the new capabilities of REGAE, powder samples were prepared from different metals, which were deposited on silicon nitride (SiN) membranes. Diffraction patterns were recorded at an electron energy of 3.66 MeV on the ultrahigh-vacuum (UHV)-compatible Jungfrau 1M detector. The derived radially integrated powder diffraction patterns from a thin-film nickel sample could be well indexed (Fig. 1) and highlight the very good signal-to-noise ratio achievable at REGAE in the current configuration.

### New experimental capabilities at REGAE

A new experimental chamber for REGAE has been designed and is expected to be delivered in 2022 (Fig. 2, left). It will be equipped with a large door on the front side and will provide much easier access to the sample area than previously possible. The door sealing will be differentially pumped, so that a high-quality vacuum in the  $10^{-9}$  mbar range can be achieved. The new chamber can host three different experimental setups simultaneously, so that switching between configurations, e.g. between the solid-state diffraction setup and the setup for diffraction experiments with liquids, can be performed without removal of the setups. All experiments can be conducted in a time-resolved laser pump-probe fashion with femtosecond time resolution.

For diffraction experiments with solid samples, a high-precision Roadrunner goniometer will be available (Fig. 2,

right). The main component of the goniometer is a high-precision rotation axis in the vertical direction with a sphere of confusion smaller than  $1 \mu\text{m}$ , which can be tilted and rotated and which will make it possible to move different samples mounted on one sample holder into the electron beam and to select interesting areas of the sample for diffraction analysis. For diffraction experiments with liquid samples, a special sheet jet setup will be installed in the experimental chamber, which can provide very thin liquid sheets with lateral dimensions of several hundred micrometres and a thickness smaller than 100 nm. The sheet jet setup will be compatible with the on-axis sample viewing microscope and the UHV quality required for the operation of REGAE. In addition to space for these two standard setups, a third setting is available for non-standard configurations, such as special setups provided by user groups.

### Outlook for 2022

In addition to the installation of the new experimental chamber with extended capabilities, first experiments in the new 3 GHz bunch train mode will also be performed in 2022. This new operation mode is currently being implemented. The bunch trains with a duration of about  $1.5 \mu\text{s}$  will make it possible to perform first microdiffraction experiments with an electron beam size of a few micrometres only. Thanks to the very small beam emittance, a sufficiently large coherence length can be provided for structural investigations on samples with large unit cells, such as protein crystals.

Contact: Alke Meents, [alke.meents@desy.de](mailto:alke.meents@desy.de)  
Klaus Flöttmann, [klaus.floettmann@desy.de](mailto:klaus.floettmann@desy.de)

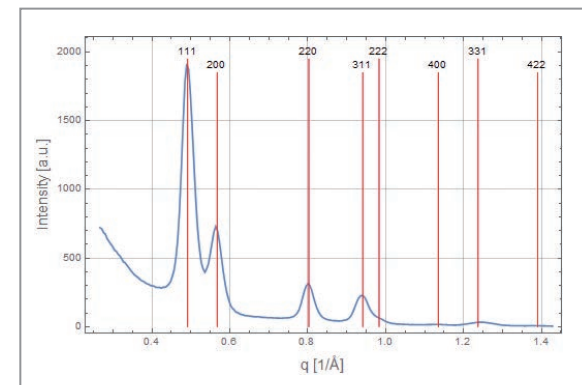
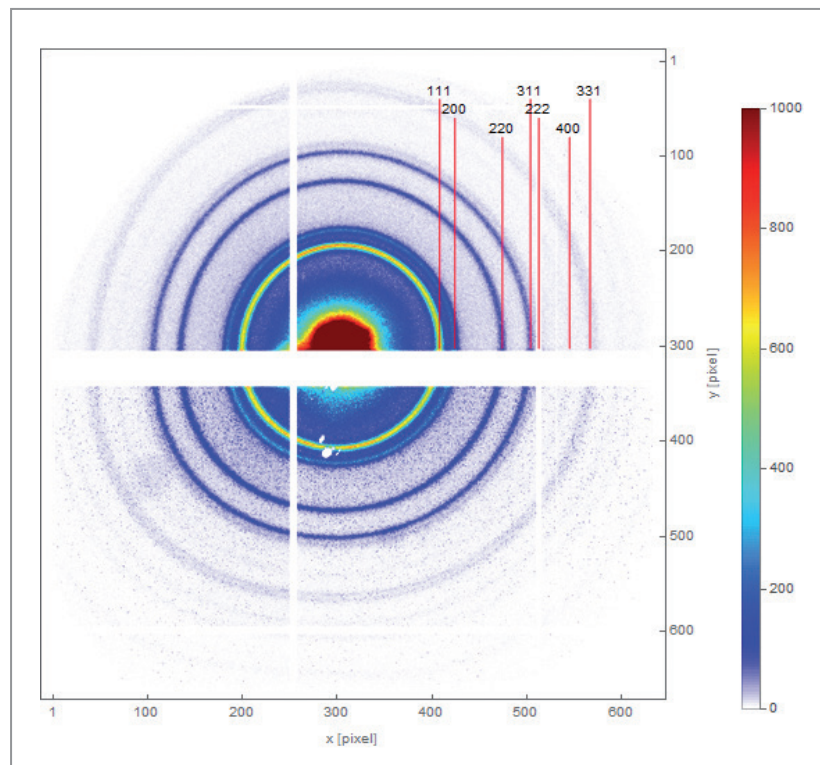

Figure 1

Powder diffraction patterns recorded at REGAE at 50 Hz repetition rate. Left: Sum of 250 single-shot diffraction patterns from nickel nanocrystals with a thickness of 100 nm grown on a 70 nm SiN membrane. Right: Corresponding radially integrated and indexed powder diffraction pattern with Miller indices highlighted in red. An elliptical correction was applied for generation of the radially integrated diffraction patterns to compensate for the observed distortions of the powder rings from an ideal circular shape (probably caused by magnetic interference from a component installed between the sample position and the detector).



# European XFEL accelerator

Routine accelerator operation and novel FEL source development

In 2021, the European XFEL accelerator complex – which is run by DESY – was reliable and stable in operation. The superconducting accelerator and its handling have largely matured, and the accelerator delivers electrons with energies up to 17.5 GeV to serve the ever-varying operational needs of the European XFEL X-ray laser facility. In addition to regular X-ray photon delivery, important developments have been pursued both on the accelerator and on the free-electron laser (FEL) sources, yielding record FEL photon energies and intensities. New installations include four APPLE-X undulators to create polarised FEL beams and a 5 m long corrugated structure to produce wakefields.

## Summary of operation

In 2021, the European XFEL accelerator complex – consisting of the injector, the 17.5 GeV superconducting linear accelerator, the electron beam distribution and the beam transport system through the three undulators to the beam dumps – was operated for 6648 h. Photon delivery to the experiment hutches was scheduled for 4036 h, and the availability, measured as the fraction of time during which self-amplified spontaneous emission (SASE) photons are actually delivered within the scheduled period, was about 94% (averaged over all three FELs). This excellent number gives credit to the diligent and creative work of

all the people involved in the operation, both at DESY and at European XFEL.

The infrastructure required to support the operation – namely the cryogenic plant, but also power, water cooling, air conditioning, IT infrastructure and safety systems – has essentially been in operation 365 days per year. A notable achievement was the further reduction of vulnerability to short voltage variations in the main grid, resulting in less interruption of the European XFEL operation during the summer months compared to the other user facilities on the DESY campus.

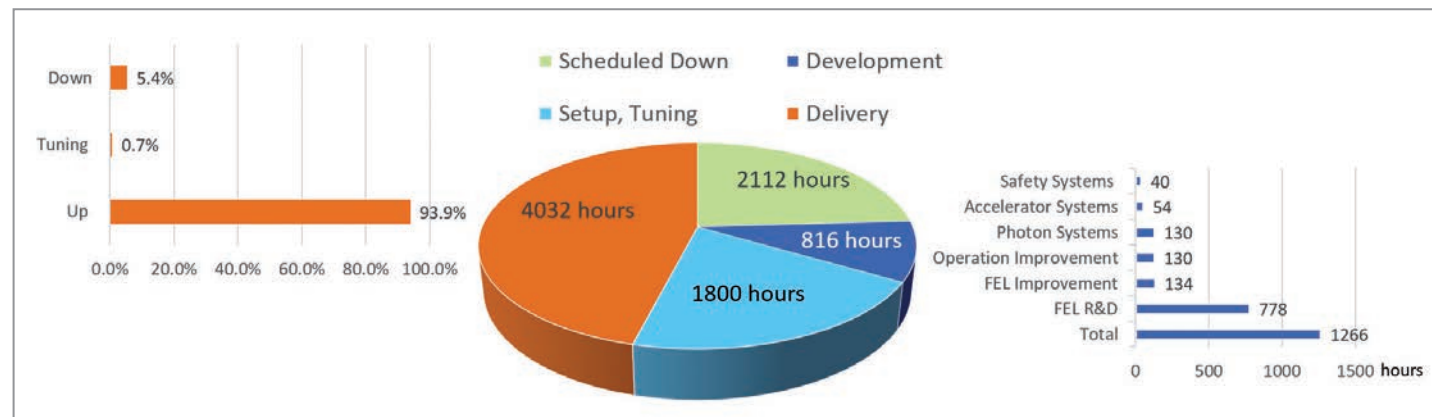

Figure 1 Centre: Distribution of yearly operating hours by category. Left: Availability during the scheduled photon delivery time in percent. Right: Distribution of development time in hours. Due to the parallel use of the facility for qualified activities, the sum of scheduled development hours exceeds the operating time scheduled for development (816 h in the central diagram).



Figure 2 Transport of one of the APPLE-X undulators in the European XFEL undulator tunnel

## New developments

The accelerator and the three FEL sources SASE1, SASE2 and SASE3 have been improved both through optimised operation and through dedicated development activities. An outstanding achievement was the deployment of a longitudinal intra-train beam stabilisation system, in addition to the already operating transverse system, which allows the electron beam arrival time to be stabilised to below 10 fs RMS both within the train and over long time periods. The FEL performance was improved in terms of photon energy (reaching 24 keV at SASE1 and 30 keV at SASE2), pulse energy (yielding 17 mJ at SASE3), pulse length (approaching <10 fs at SASE2 and SASE3 using various bunch shaping techniques) and spectral brightness (by delivering hard X-ray self-seeding to users, resulting in an increase in spectral brightness by up to a factor of 8 over standard SASE operation). Standard user operation also benefited from the development of an advanced photon safety system that allowed the limits imposed on the photon beam power to be raised by up to a factor of 50 in certain cases.

## Installations

A regular operating year includes two maintenance periods totalling about six working weeks, which are used for new installations in the accelerator system in addition to the standard preventive maintenance and repair. The largest alteration in 2021 was the installation of four APPLE-X-type undulators at the end of the SASE3 undulator. These devices will eventually produce polarised FEL beams. Preparations of the electron beam transport section had already started in 2020, and this year, the transport of these 8 t devices on air cushions to their position in the tunnels was a particular challenge.

Behind the SASE2 undulator, a 5 m long corrugated structure was installed in the accelerator vacuum system. The wakefields produced in this structure by the electron bunch itself act back on the same bunch and allow its longitudinal structure to be observed on a downstream screen. With these diagnostics, insights into the lasing process can be gained.

Contact: Winfried Decking, [winfried.decking@desy.de](mailto:winfried.decking@desy.de)



# Developing technology for future facilities

Test setup for characterising the KALDERA laser crystal  
(more info: see p. 66)

Picture: Juan González Díaz, DESY

## Highlights · New technology · Developments

>	PETRA IV	36
>	PETRA IV CAD integration	38
>	PETRA IV BPM readout system	40
>	FLASH highlights	42
>	FLASH2020+	44
>	Xseed at FLASH	46
>	Seeding simulations	48
>	Vlasov systems for FELs	50
>	High-repetition-rate seeded FEL	52
>	Mixed lasing at FLASH	54
>	PolariX	56
>	FLASH2020+ waveguide distributions	58
>	FLASH photocathodes	60
>	FLASHForward	62
>	LUX	64
>	KALDERA	66
>	Thomson scattering diagnostics	68
>	Plasma injector prototype	70
>	HiPACE++	72
>	SINBAD-ARES	74
>	Autonomous accelerators	76
>	Attoseconds for accelerators	78
>	iDAS seismic sensing	80
>	Mixed-reality solutions for laser safety	82
>	European XFEL safety	84
>	Quality assurance	86
>	Cryogenics for ALPS II	88



# PETRA IV

The ultimate 3D X-ray microscope

The PETRA IV project is the upgrade of DESY's PETRA III synchrotron radiation facility to a diffraction-limited hard X-ray radiation source. The delivery of high-flux coherent photon beams will be made possible with a new type of storage ring magnetic lattice design, the hybrid multi-bend achromat (HMBA), pioneered at the ESRF-EBS facility in Grenoble, France. With its large ring circumference of approximately 2.3 km, PETRA IV will deliver a horizontal emittance in the 20 pm rad range and will be diffraction-limited up to 10 keV photon energy, becoming the brightest source in its class. The technical design of the facility is gaining momentum, with many subsystems reaching a high degree of maturity and with the prototyping of a number of critical components under way or ready to start. Logistics and construction planning has been established. Assuming full project approval in 2023, construction could start in 2026 and the first beam could be delivered to the users in 2028, ushering in a new era of X-ray science at DESY.

## Goals of the project

The multi-bend achromat storage ring optics has opened the door for electron storage rings to deliver ultralow-emittance electron beams, which, travelling through undulators, produce diffraction-limited photon beams well into the hard X ray spectral range. The first such user facilities already in operation are MAX IV (Sweden) and Sirius (Brazil) in the soft X-ray regime and ESRF-EBS for hard X-rays. More facilities are expected to come online within the decade, such as APS-U (USA), HEPS (China) and SLS-2 (Switzerland). With PETRA IV, DESY plans to upgrade its existing PETRA III electron storage ring to a diffraction-limited X-ray light source with up to 10 keV photon energy.



**Figure 1**  
Artist's view of the DESY campus in Hamburg with PETRA IV and the planned new experimental Hall West (PXW)

The storage ring will utilise a number of advanced modern technologies: solid-state amplifiers to feed the radio frequency (RF) cavities, permanent magnets for the main storage ring to reduce power consumption, non-evaporable getter (NEG)-coated vacuum chambers instead of more traditional pumps and nanosecond-range injection kickers. R&D towards a novel plasma-based injector is being pursued. Along with the new storage ring, the project will also upgrade the injector complex, adding a new low-emittance booster ring (DESY IV). A new experimental hall of approximately 600 m length accommodating new experimental stations will also be added (Fig. 1).

## Project schedule update

At present, the upgrade project is in its technical design phase, which started at the beginning of 2020 and will end with a technical design report (TDR) planned for mid-2023 (Fig. 2). Assuming full project approval in 2023, the project will continue with an upgrade preparation and procurement phase from mid-2023 until the end of 2025. Then, user operation of PETRA III will be stopped. Construction of PETRA IV will start at the beginning of 2026 and continue in 2026 and 2027. The technical commissioning will begin in mid-2027, and user operation is envisioned for the beginning of 2028.

## Improvement of storage ring performance with H6BA lattice

In 2021, the second year of the TDR phase, a substantial number of activities were initiated or expanded, with many new members joining the project across all DESY divisions. The expansion was most prominent in the technical groups.

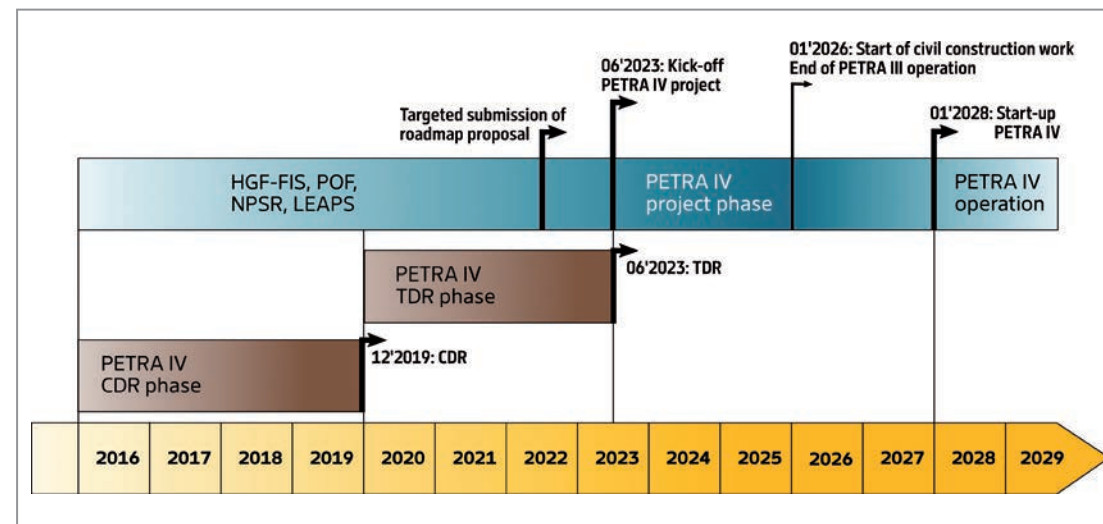

**Figure 2**  
Current schedule of the PETRA IV project, showing the shutdown of PETRA III in early 2025 and the resuming of user operation at the beginning of 2028

**Figure 3**  
CAD model of the unit cell of the H6BA lattice

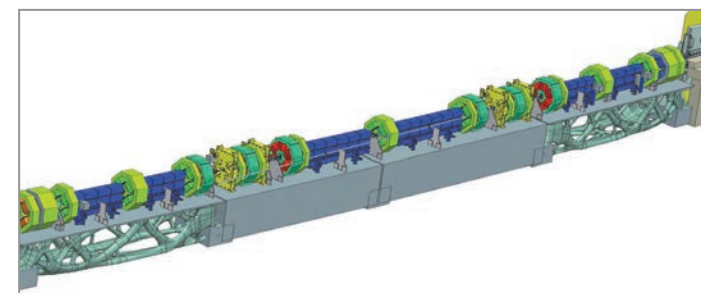

The design review process was initiated, and a dedicated Technical Advisory Committee (TAC) composed of internationally renowned experts was established.

In collaboration with colleagues from ESRF, the design team made significant advances on the lattice and component design. A new lattice version was developed, reducing the number of bends per unit cell from seven to six. The new hybrid six-bend achromat (H6BA) lattice version shows superior beam dynamics performance compared to the previously considered H7BA version and even allows for nine cells per arc, thus preserving the beamline sector layout in the existing experimental halls in the east of the storage ring and adding two beamline locations in the planned Hall West.

Progress has been made on all technical subsystems: The preliminary magnet design (including permanent magnets) is in place, the RF system design is mature, the vacuum system and girder designs have made significant progress, and the engineering integration of all components is under development (Fig. 3). Mechanical stability, an issue of paramount importance for ultralow-emittance rings that is particularly challenging in an urban environment such as Hamburg, is being addressed by a dedicated taskforce.

## New beamline portfolio for PETRA IV

By the end of 2020, the international user community had submitted approx. 160 scientific instrument proposals to define a user-driven beamline portfolio for science and industry. Starting from this input, the project team in the DESY Photon Science division developed a first set of beamlines for PETRA IV, which were scientifically and

strategically reviewed by external experts and the DESY Photon Science Committee (PSC). From all the ideas and the recommendations of the reviewers, 28 beamlines from the presently foreseen 33 beamline slots were allocated as a first beamline portfolio of PETRA IV, covering a broad range of applications from imaging on the nanoscale to automated high-throughput stations dedicated to industrial applications.

## Outlook

In 2022, the technical design of the new experiments and beamlines will start, and the process of defining the new beamline portfolio will be completed with the publication of the results in a report for the user community.

With the design of the storage ring lattice and the new beamlines defined, the focus of the project team will move on to the technical infrastructure, civil engineering and component production planning. A draft project proposal is expected to be ready by summer 2022, and the detailed TDR by mid-2023. After that, provided the bid for funding is successful, the project will be ready to go full steam ahead.

Contact: Riccardo Bartolini, [riccardo.bartolini@desy.de](mailto:riccardo.bartolini@desy.de)  
Ilya Agapov, [ilya.agapov@desy.de](mailto:ilya.agapov@desy.de)

## Reference:

[1] [https://petra4.desy.de/index\\_eng.html](https://petra4.desy.de/index_eng.html)



# CAD integration for PETRA IV

One model to bind them all together

Developing an advanced accelerator facility such as DESY's planned PETRA IV diffraction-limited hard X-ray radiation source is a complex technical endeavour. It requires a coordinated effort of many technical fields that contribute to the overall design. Based on the experience from past accelerator projects, in particular the European XFEL X-ray free-electron laser and the ARES accelerator at DESY's SINBAD facility, an integration model encompassing the complete PETRA project has been set up by the PETRA IV team in charge of the technical coordination.

## Rationale for an integration model

The design of PETRA IV is highly complex and poses a number of challenges to the computer-aided design (CAD) processes and models. The PETRA programme will continue for decades, and CAD models are needed over the entire lifecycle of the facility as the basis for processes ranging from layout, detailed engineering and installation to maintenance, modifications and upgrades. Based on the Siemens NX CAD programme and Teamcenter product lifecycle management (PLM) system, we have set up an integration model to fulfil these requirements.

## Methods and solutions

A centrally defined and maintained *model structure* is a key element to the success of the integration process. The top levels of the model structure reflect key decisions in the project, concerning project organisation and responsibilities, work packages, project phases and design alternatives to be studied. The model structure has a hierarchy with levels corresponding to the product structure (e.g.: PETRA programme, accelerator complex, PETRA IV accelerator facility, arc cell "U"), the configurations that are designed (PETRA III vs. PETRA IV-H6BA), the trades

involved (diagnostics, magnets, vacuum) and the design process (levels of detail DG1 to DG3). Figure 1 shows the overall model, with the four main complexes accelerator, photon science, buildings and campus.

*Modularisation*, combined with modelling in *different levels of detail*, is a second key concept. Units with a defined functional and spatial extent form modules that serve as building blocks for the integration model. Modules, such as an accelerator arc cell, occupy a certain space, which they own, and should have a set of defined interfaces. A coarse "shoe box" space model shows the approximate spatial extent (level of detail DG1), a more detailed model is good enough for clash checks and indicates interfaces (DG2), and the full internal details are available in the highest level of detail (DG3). This modular approach serves the same purposes as similar approaches in software and systems engineering, with encapsulation, interface definitions, or black box / white box models. Not only do they address the performance issue by providing light-weight, simplified models that are fast to load and display, but they show the overall layout structure without the clutter of too many details and they contain crucial information such as space for maintenance and movement as well as tolerance. Figure 2 shows how the modularisation concept is applied to a sector of the "Max von Laue" experimental hall.

Combining different levels of detail within the same model makes it possible to maintain and verify the consistency of these models at all times, which is of paramount importance during intense phases of design when the model changes often and it has to be ensured that all stakeholders are aware of these changes at all times.

*Parametric models* with a direct connection between a defining document (typically, a Microsoft Excel spreadsheet) and geometric 3D entities, such as coordinate systems or volumes, are a third pillar of the integration model. Parameter tables as output of design processes, including simulations, calculations and other specifications, but also surveys and measurements, are ubiquitous, easily produced by a variety of tools and well suited for review, release and signoff processes. CAD models that define locations and properties of buildings, accelerator components or interfaces, taking data directly from Excel documents managed in Teamcenter, ensure coherence and consistency of the mechanical design with the specifications and enable fast and faithful implementation of design changes. Processes within the PETRA IV project strongly rely on these mechanisms to aid the sharing of information and reduce the risk of error and miscommunication.

## Results and benefits

We have set up a CAD integration model encompassing the complete PETRA programme. At the highest level, the model is already helping to develop a shared vision for the project, showing the extent of the PETRA ring including the

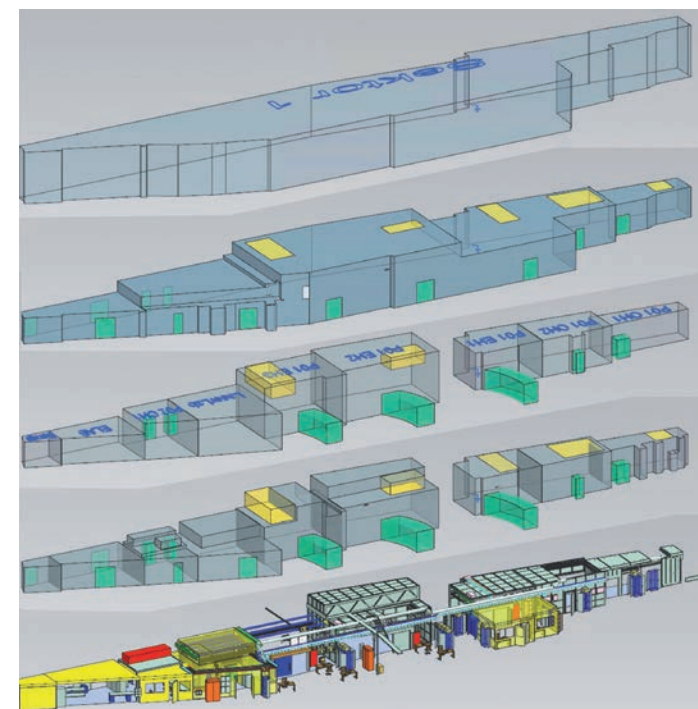

Figure 2  
Sector 1 of the "Max von Laue" hall, from top to bottom, in detail grades (DG): DG1 (outline), DG2 (with interfaces), DG3 (interior) with huts in DG1, DG3 with huts in DG2, DG3 in full detail. Yellow areas designate crane transport routes, green areas indicate escape routes.

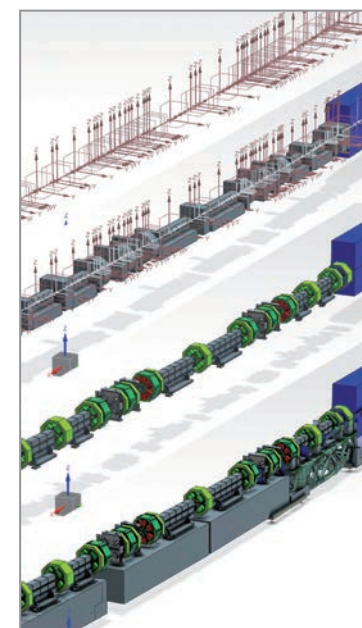

Figure 3  
From lattice parametrisation to the full cell. From top to bottom: Coordinate systems of lattice components, DG1 models of accelerator components inserted, accelerator component conceptual models, vacuum system and supports added.

whole chain of pre-accelerators and transfer lines, the new and existing experimental halls, and how they fit into the DESY campus and their surroundings. The model structure reflects the overall product breakdown structure and is instrumental in cross-checking and completing it, whether it is a list of the buildings belonging to or affected by the project, or a list of accelerator components or subsystems.

Contact: [markus.huening@desy.de](mailto:markus.huening@desy.de)  
[benno.list@desy.de](mailto:benno.list@desy.de)



Figure 1  
View of the complete integration model. Left: Building complex, accelerator complex, photon science complex and campus map shown separately.



# Modular low-drift BPM readout system for PETRA IV

Towards lowest drifts and modularity

The PETRA IV project at DESY aims to upgrade the present synchrotron radiation source PETRA III to an ultralow-emittance source. As the small targeted beam emittance of about 20 pm rad translates directly into much smaller beam sizes of 7 µm in both planes at insertion device source points than currently needed at PETRA III, stringent requirements are imposed on machine stability. A high-resolution beam position monitor (BPM) system of about 800 monitors is under development at DESY, with readout electronics based on the modular MTCA.4 platform, in order to measure beam positions and control the orbit stability to the required accuracy level. An extended crossbar-switching compensation scheme will enable long-term beam position drifts of less than 1 µm per week, as required.

## BPM systems at PETRA III and PETRA IV

Since its start of operation in 2009, PETRA III has been successfully operated using the Libera Brilliance Button BPM readout system developed and customised by the Slovenian company Instrumentation Technologies in cooperation with DESY's Diagnostics and Instrumentation group. The readout technology is based on the proven crossbar-switching concept to level out signal drifts between all four button signals in the radio frequency (RF) input circuit of the readout electronics.

Even higher demands are placed on the properties of the new BPM system under development for the PETRA IV upgrade project, as summarised in Table 1.

Driven by the demands for significantly lower input signal drifts in the new button BPM readout electronics for PETRA IV, a pilot tone front-end signal compensation

scheme developed by Sincrotrone Trieste for the ELETTRA accelerator [1] was tested at PETRA III and shown to exhibit significant conceptual disadvantages for use at PETRA IV.

In consequence, DESY proposed an improved version of the front-end signal compensation scheme based on the proven crossbar-switching technology used in Instrumentation Technologies' Libera electronics [2]. This upgraded readout system concept aims to improve compensation by incorporating the RF front-end cables into the drift-compensated signal paths. This was successfully achieved by shifting the point of contact of the upfront crossbar switches from the RF front-end towards the pickups in the accelerator tunnel, hence stabilising the cable paths.

A further improved readout system based on MicroTCA.4, which is foreseen as the mandatory standard for use in future modular systems at PETRA IV, is currently under

Measurement performance parameter	Conditions	Required values
Resolution on single bunch per turn	0.5 mA/bunch	< 10 µm
Resolution on closed orbit	200 mA in 1600 bunches at 1 kHz bandwidth	< 100 nm (RMS)
Beam current dependence	60 dB range, centred beam	± 2 µm
Long-term stability	Measured over 6 days, temperature span ± 1°C within a stabilised rack	< 1 µm

Table 1

Summary of demands on the measurement performance parameters for the new PETRA IV button BPM system

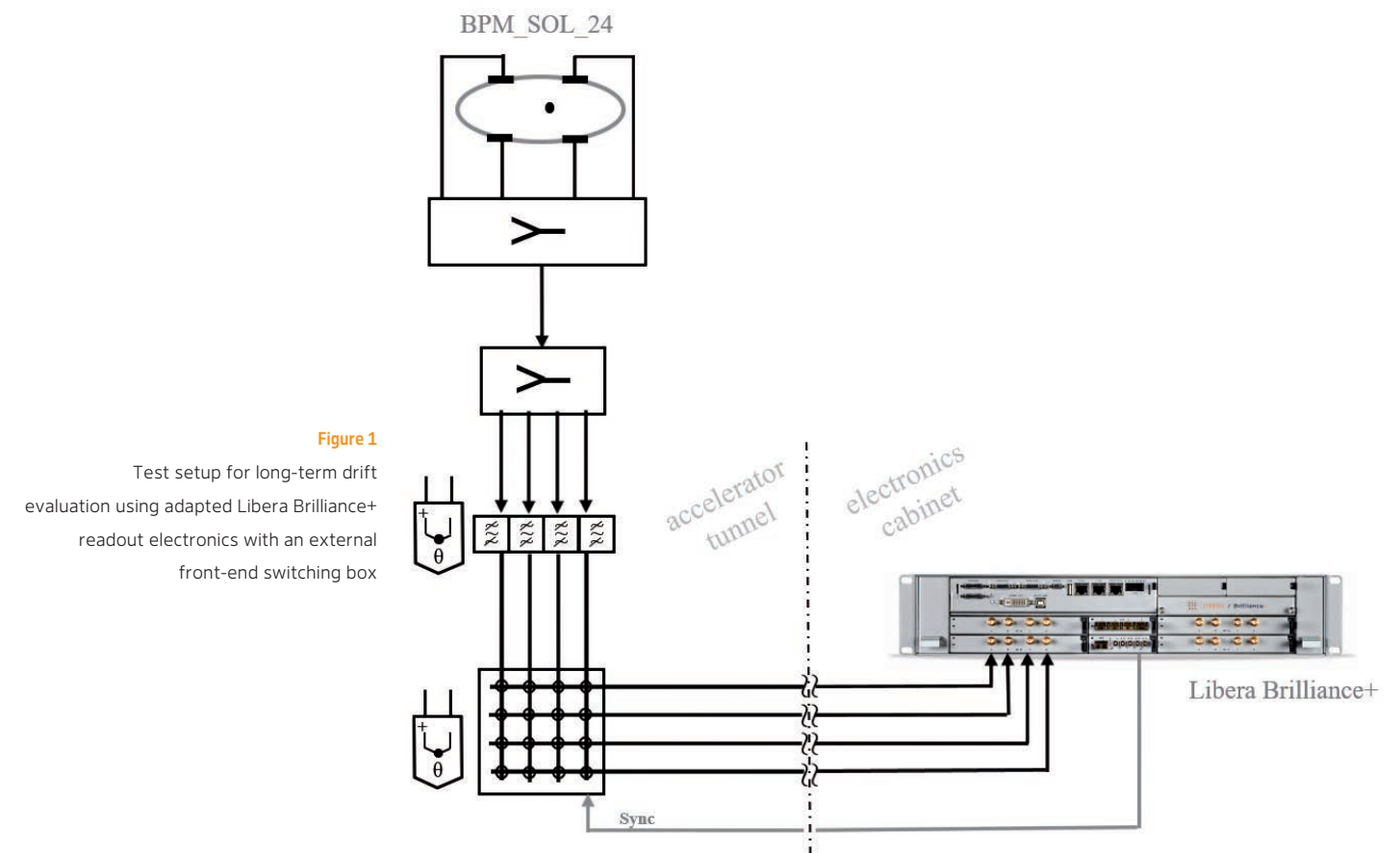

Figure 1  
Test setup for long-term drift evaluation using adapted Libera Brilliance+ readout electronics with an external front-end switching box

development in a close cooperation of Instrumentation Technologies and DESY. Evaluation measurements for this system were successfully carried out in 2021 at PETRA III [3], using an adapted version of the latest commercially available Libera Brilliance+ readout system within the extended crossbar-switching concept (Fig. 1).

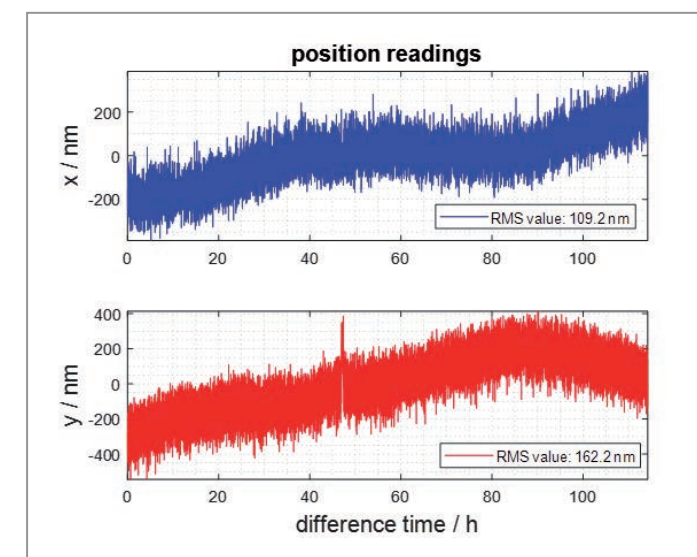

Figure 2  
Evaluation measurements with the adapted Libera Brilliance+ readout electronics setup at PETRA III shown in Fig. 1, indicating that the long-term drifts in BPM position measurements in slow-acquisition data (0.1 Hz) over around four days in both transversal planes are well below the specification limit of 1 µm.

## First measurements with the new low-drift concept

As shown in Fig. 2, the long-term drifts in BPM position measurements in slow-acquisition data (conducted in 2021 using the test setup of Fig. 1 at PETRA III) are well below the specification limit of 1 µm, as required for the operation of PETRA IV. The measurements were based on 45 000 consecutive slow-acquisition samples at 0.1 Hz sampling rate taken from a normal PETRA III user run with 40 bunches at 100 mA beam current.

Such an improved BPM readout system based on MTCA.4 will be used for the upcoming test and integration measurements of the BPM and transverse fast orbit feedback (FOFB) systems within the current technical design report phase of the PETRA IV project. The modular system design enables further upgrades, such as the integration of FOFB systems.

Contact: Frank Schmidt-Föhre,  
frank.schmidt-foehre@desy.de  
Gero Kube, gero.kube@desy.de

## References:

- [1] G. Brajnik *et al.*, Libera Workshop 2021, [https://www.i-tech.si/wp-content/uploads/2021/06/8.-Gabriele-Brajnik\\_Elettra\\_compressed.pdf](https://www.i-tech.si/wp-content/uploads/2021/06/8.-Gabriele-Brajnik_Elettra_compressed.pdf)
- [2] F. Schmidt-Föhre *et al.*, Proc. IBIC2021, MOPP36 (2021)
- [3] G. Kube *et al.*, Proc. IBIC2021, MOPP30 (2021)



# FLASH highlights

Seeking an even brighter future

DESY's FLASH free-electron laser (FEL) facility is not only a unique FEL user facility, it also offers opportunities for versatile accelerator and photon science developments. The facility is continuously being developed through refurbishment and modernisation work. Some of the upgrades, such as a new bunch compressor in the FLASH2 beamline and PolariX, a transverse deflecting structure, are already in operation, others are on the way to realisation. The FLASH2020+ project [1] is a major upgrade of the facility offering many new opportunities, such as external seeding. FLASH also hosts the FLASHForward plasma wakefield acceleration experiment, which provides new and often surprising insights into the science of plasma acceleration.

## Xseed – a major step towards FLASH2020+ external seeding

In an outstanding experiment, the Xseed team has proven for the first time worldwide that parallel operation of self-amplified spontaneous emission (SASE) on one beamline and high-gain harmonic generation (HG) external seeding on a second beamline is actually possible. The two FLASH beamlines – FLASH1 and FLASH2 – are operated in tandem using the same radio frequency (RF) pulse with the full 10 Hz repetition rate. To a certain extent, the amplitude and phase of the RF can be different for FLASH1 and FLASH2 so as to be able to deliver electron bunches with different parameters adapted to the needs of the specific beamline. Previously, there had been the concern that the electron beam phase space required for seeding would be so different from that for SASE that it would be impossible to operate both beamlines in parallel. In an experimental campaign in 2021, the Xseed team has shown that tailoring the phase space for both beamlines is indeed possible, demonstrating HG seeding in FLASH1 in parallel with SASE in FLASH2 with 2000 bunches per second.

Progress towards echo-enabled harmonic generation (EEHG) seeding has also been made: Overlap of two laser beams with the electron beam – both transversely and in time – was successfully achieved in the modulator–chicane segments of the EEHG experiment (Fig. 1). The focus is also on analytical and simulation studies and tool developments to prepare the EEHG experiment.

## PolariX – measuring the electron and FEL pulse duration with femtosecond precision

In the winter shutdown 2020/21, a pair of new PolariX [2] RF structures was installed directly downstream of the SASE undulators (see annual report *DESY Accelerators 2020*). PolariX is a novel type of deflecting structure developed in a collaboration between DESY, PSI and CERN. Its new feature is the ability to change the streak direction. The structure basically streaks or kicks the electrons to the side, with the strength of the kick being a function of time. In the longitudinal phase space of the electrons, this allows for measuring both the energy profile and the charge distribution along the electron bunch. The longitudinal charge distribution is also used to deduce the FEL pulse length with femtosecond resolution. Since the electrons lose part of their energy during FEL emission, their energy profile behind the undulators can be used to measure the FEL photon pulse length in a complementary fashion. The PolariX structure was conditioned during the year. Although the RF pulse compressor (X-BOC) required for best resolution has not yet been conditioned to full specifications, the PolariX structure is already serving user experiments.

## Vlasov systems for studying dynamics in FELs

Optimising the performance of FELs such as FLASH requires excellent understanding of the processes that determine the evolution of the beam parameters along

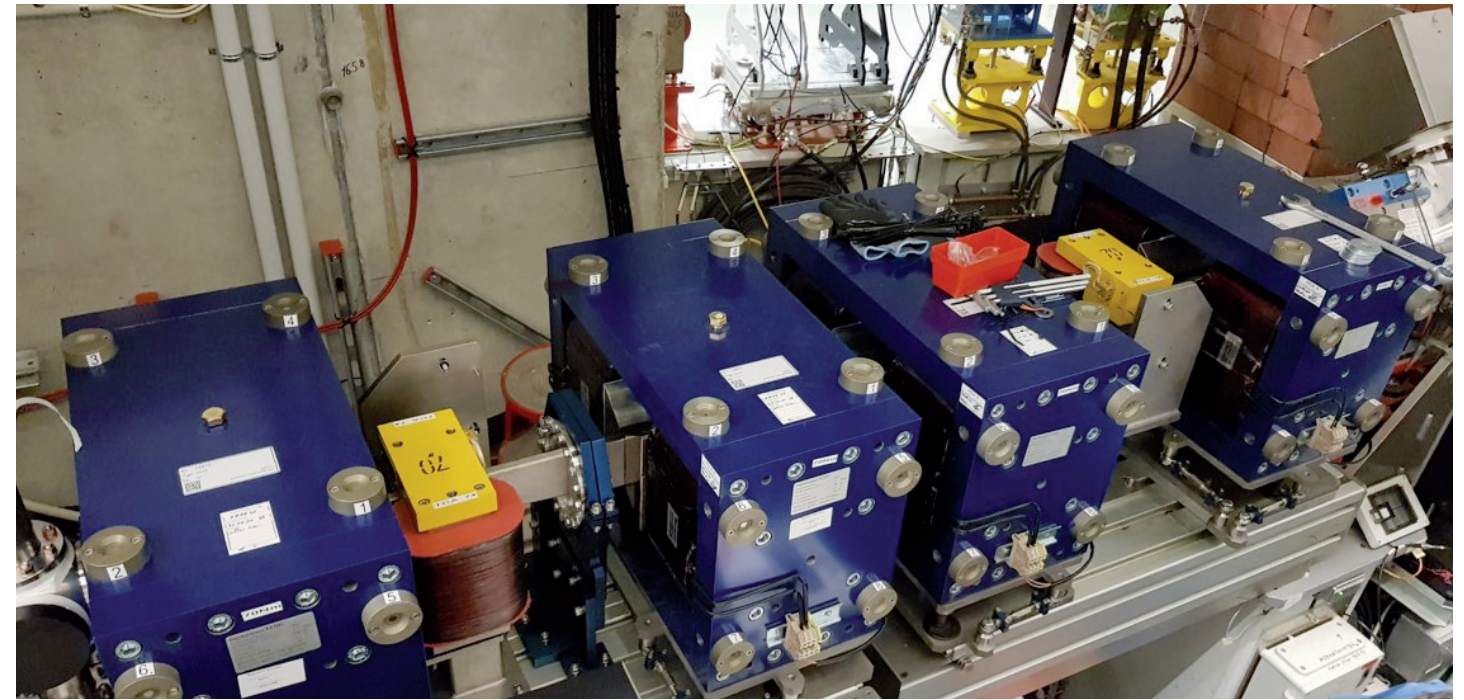

Figure 1

EEHG chicane in the Xseed section of the FLASH1 beamline

the accelerator. A key ingredient is the evolution of the longitudinal phase space density, in particular the effect of unwanted, though unavoidable collective effects, i.e. the effect of forces that the beam exerts on itself through the electromagnetic interaction among the particles in the beam. Dynamics of this type are described using a method that is well established in plasma physics: the Vlasov equation and its solutions based on the Liouville principle. The FLASH Accelerator team analysed solvable examples and developed a special simulation software (libselav, SelaV1D). It is capable of sampling the particle densities with extremely high resolution without wasting memory in regions of sparsely populated phase space. This feature allows the dynamics to be simulated on small scales with an adequate resolution and without the inherent artificial noise from which the popular macro-particle simulations suffer. The models and codes are used to better understand the microbunching mechanism in FLASH, which is essential input for the FLASH2020+ project.

## Mixture of lasing schemes for tricky experiments

The flexibility of variable-gap undulators in the FLASH2 beamline opens up a wide range of scientific opportunities. Different advanced lasing schemes have been tested in the past years, such as the frequency doubler scheme, two-colour lasing and harmonic lasing self-seeded (HLSS) FEL. A recent experiment required parameters never provided before: equal power in the fundamental wavelength

and the third harmonic. With a trick, combining HLSS and two-colour lasing, a tailored two-colour beam could be delivered to an experiment for the first time.

## FLASHForward – significant advances in plasma acceleration

2021 was a very productive year for the FLASHForward plasma wakefield acceleration experiment. After careful commissioning of the FLASHForward beamline in 2020, the year 2021 was devoted exclusively to experimentation. A great amount of data was collected over hundreds of hours. Most impressively, first results on operating plasma accelerators at high repetition rates were recorded, demonstrating for the first time the in-principle feasibility of accelerating millions of bunches per second in plasma [3]. The next step will be to consider how best to transfer this result to a practical plasma-based accelerator in the future.

Contact: Siegfried Schreiber, [siegfried.schreiber@desy.de](mailto:siegfried.schreiber@desy.de)

## References:

- [1] L. Schaper *et al.*, *Appl. Sci.* **11**, 9729 (2021)
- [2] B. Marchetti *et al.*, *Sci. Rep.* **11**, 3560 (2021)
- [3] R. D'Arcy *et al.*, *Nature* **603**, 58–62 (2022)



The upgrade of DESY's FLASH free-electron laser (FEL) facility, realised within the FLASH2020+ project, has successfully started. A nine-month shutdown from November 2021 to August 2022 allows for a complete overhaul of the accelerator section, and installation work is well on track. New accelerating modules will enable higher electron beam energy, and a new laser heater will make it possible to extend the parameter range for operation while allowing higher-quality photon beams to be produced. In a second installation phase in 2024, the FLASH1 beamline will be replaced. The new FLASH1 will feature external seeding, where the pulse properties of an ultraviolet (UV) laser beam are mapped onto the soft X-ray regime at MHz repetition rate. The FLASH2 beamline will be operated in self-amplified spontaneous emission (SASE) mode in parallel. With those two beamlines in combination, the FLASH facility will offer the broadest possible parameter range to future users.

### Project goal and timeline

The FLASH2020+ project includes major upgrades to FLASH to provide a facility that is eagerly anticipated by the soft X-ray community for the next generation of experiments. The upgrades will be carried out in two long shutdown periods to ensure the availability of the facility for users, reduce the overall downtime and gain experience with operation. The final goal of the project is to deliver seeded FEL radiation at MHz repetition rate in burst mode. Even before the current shutdown, two subprojects, marked in light pink in Fig. 1, were successfully completed. The FLASH2 dedicated bunch compressor is already in daily operation, and the FLASH2 transverse deflecting

structure, called PolariX, is currently being conditioned to deliver the highest possible time resolution in future experiments.

### Project progress

The FLASH2020+ project team began the year 2021 by finalising the technical details so that the accelerator upgrade could be completed on time. In November 2021, the nine-month shutdown started, with focus on the accelerator section to enhance the electron beam properties and broaden the available parameter range for users. Work began with the superconducting accelerator modules

**Figure 2**  
Ongoing refurbishment of the FLASH linear accelerator. The section downstream of the first bunch compressor and the ACC2 and ACC3 accelerator modules (top) were removed from the tunnel (middle) and are being replaced by a new first bunch compressor with laser heater and by European-XFEL-type accelerating modules (bottom), allowing for a higher accelerating gradient and thus shorter photon wavelengths.



being warmed up from their 2 K operation temperature, allowing for the exchange of two out of seven modules. They were replaced by two new, state-of-the-art modules following the European XFEL design (Fig. 2). The exchange will increase the maximum electron energy of FLASH by 100 MeV to a total of 1.35 GeV. This will result in shorter photon wavelengths becoming available to users and extend the feasible experimental applications.

In addition to the new modules, new photoinjector lasers will be installed before the start of the next user run in 2022 to improve the availability of the facility and reduce the overall downtime. To this end, a new annex to the existing building was constructed in 2021. This will house the new photoinjector lasers as well as the laser for the new laser heater, which will significantly reduce the instabilities of the electron beam.

In the "Kai Siegbahn" (FLASH2) experimental hall, installation of the new time-delay-compensating monochromator beamline FL23 started. In the "Albert Einstein" (FLASH1) experimental hall, the pump-probe laser hutch was cleared out to provide space for the new generation of pump-probe lasers.

In autumn 2021, there was a smooth change in the leadership of FLASH2020+: Lucas Schaper took over the project management from Enrico Allaria, who decided to move back to Italy for personal reasons and continues to be involved in FLASH2020+ as an external collaborator.

### Seeded FLASH1 and Xseed

The current upgrade of the FLASH linear accelerator is paving the way for the upcoming renewal of FLASH1 to an externally seeded beamline with 1 MHz repetition rate in 2024. This process requires a 12-month shutdown, during which the existing FLASH1 beamline will be completely removed and the corresponding tunnel segments will be refurbished and filled with 110 m of new beamline components. The beamline structure was recently positively reviewed by an external expert panel. The proposed mild alterations allow for even better beam collimation and lower particle loss in the new radiator section, which has a free aperture of only 6 mm. In addition, improved energy resolution and better online measurement capabilities of the electron beam phase space were incorporated. A full computer-aided design (CAD) model of the beamline has

been assembled and is being continuously refined, with some of the finalised sections close to production.

Progress has also been made in investigating the broad spectral window for future operation, spanning wavelengths from 60 nm down to 4 nm, through numerical simulations. The sensitivity to variations, commonly called jitter, in timing, compression and energy spread in particular is sufficiently small and demonstrates the feasibility of the concept. The results can already be tested at the existing facility using the infrastructure of the present Xseed experiment. In a proof-of-principle experiment, the feasibility of parallel operation of FLASH1 in externally seeded mode and FLASH2 in SASE mode was demonstrated for the first time – a great success also for the future operation of FLASH2020+.

Contact: Lucas Schaper, [lucas.schaper@desy.de](mailto:lucas.schaper@desy.de)  
Karolin Baev, [karolin.baev@desy.de](mailto:karolin.baev@desy.de)

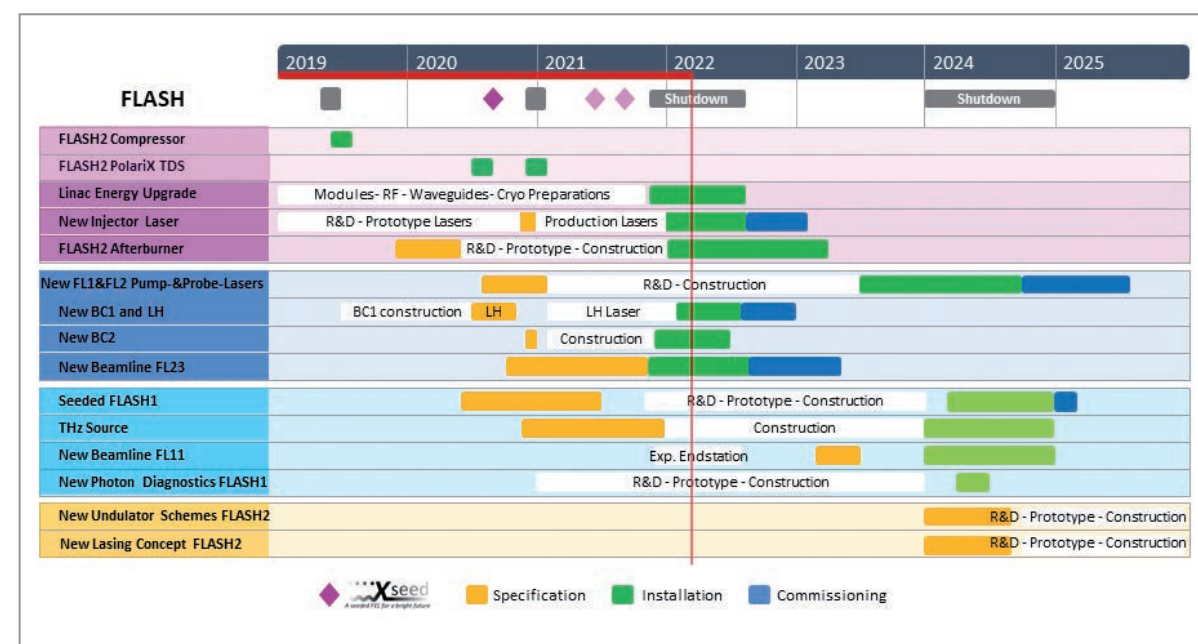

**Figure 1**  
Timeline of the subprojects of the FLASH2020+ project



# Xseed at FLASH

First-time parallel operation of SASE and seeded FEL

The seeding experiment Xseed, currently installed at DESY's FLASH free-electron laser (FEL) facility, not only serves to perform research and experiments on novel seeding techniques; it also makes major contributions to testing concepts that could be implemented in the future within the FLASH2020+ upgrade project. One of the highlights of 2021 was the world's first parallel operation of self-amplified spontaneous emission (SASE) and external seeding using the high-gain harmonic generation (HGHG) concept. In addition, the path towards more complex echo-enabled harmonic generation (EEHG), where the electron beam and the seed laser interact in two successive stages, was paved by successfully overlapping the laser and the electron beam in both interaction regions.

## New year, new beamline

In the past few years, alongside the main beamline upgrades at FLASH, the seeding section of the FLASH1 beamline, Xseed, has also been modified (Fig. 1). The most notable changes for R&D in external seeding include a modified seed laser and a new chicane specifically designed to enable the implementation of EEHG.

## Two beams in one facility

One of the persistent concerns of the FEL user community has been to preserve the SASE operation of FLASH in parallel with external seeding. With the new, fully commissioned bunch compressor in the FLASH2 beamline (FLASH2 BC in Fig. 1) and PolariX, the new X-band transverse deflecting cavity after the FLASH2 undulators, it has become possible to produce and measure two significantly different FEL beams in the FLASH1 and FLASH2 beamlines. This operational flexibility means that one of the working points for the FLASH2020+ upgrade, HGHG in the 44–27 nm wavelength regime, could now be tested.

For this purpose, the electron beam energy and charge were set to 665 MeV and 0.4 nC for FLASH1 and 655 MeV and 0.25 nC for FLASH2. The compression in the common FLASH bunch compressors (BCs) was moderate. The FLASH1 electron beam profile was determined with the deflecting cavity LOLA (Fig. 2a and 2b). In the FLASH2 beamline, the beam was further compressed by the FLASH2 BC (Fig. 2d and 2e). The FLASH1 seeded HGHG radiation was measured with a microchannel plate detector, the FLASH2 SASE radiation with the usual gas monitor detector. The data show a truly parallel operation of HGHG seeding and SASE in the FLASH1 and FLASH2 beamlines, respectively. This success is a world first and a positive answer to one of the concerns of the FLASH FEL user community.

## Progress towards EEHG

The oversharing chicane was specifically designed to allow for an increased control over the longitudinal bunch properties needed to demonstrate EEHG at Xseed. During the experimental campaigns, HGHG seeding of the sixth

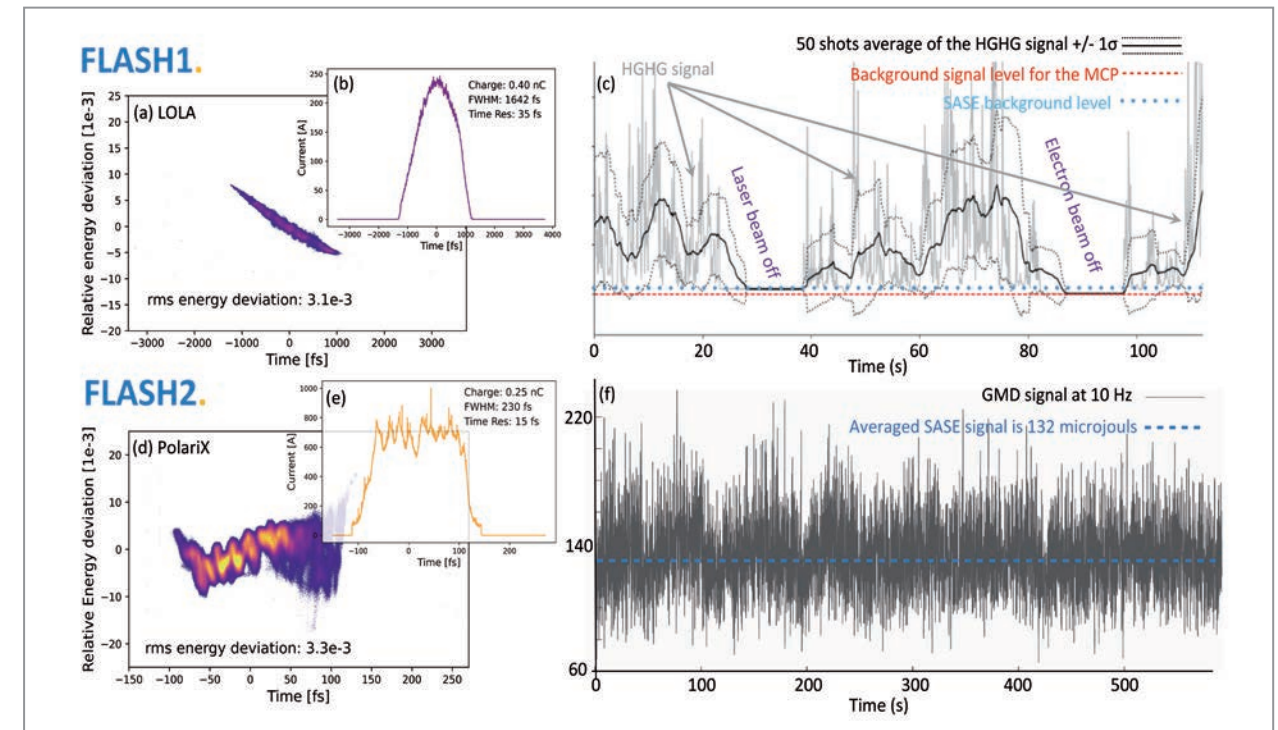

Figure 2

The electron beam's longitudinal distribution (a) and current profile (b) for FLASH1 during HGHG seeding are significantly different from the longitudinal distribution (d) and current profile (e) for FLASH2. Panel (c) shows the microchannel plate (MCP) detector signal at the sixth harmonic of the seed laser at 44 nm. The laser and the electron beam were switched off alternately to verify that the signal was not SASE. Panel (f) shows a 10 min time window of the FLASH2 SASE signal from the gas monitor detector (GMD) at 20 nm in long-bunch-train mode (200 bunches) while the setup and optimisation of the seeded signal in FLASH1 were ongoing. (Note: (a) and (d) were measured at opposite zero crossings.)

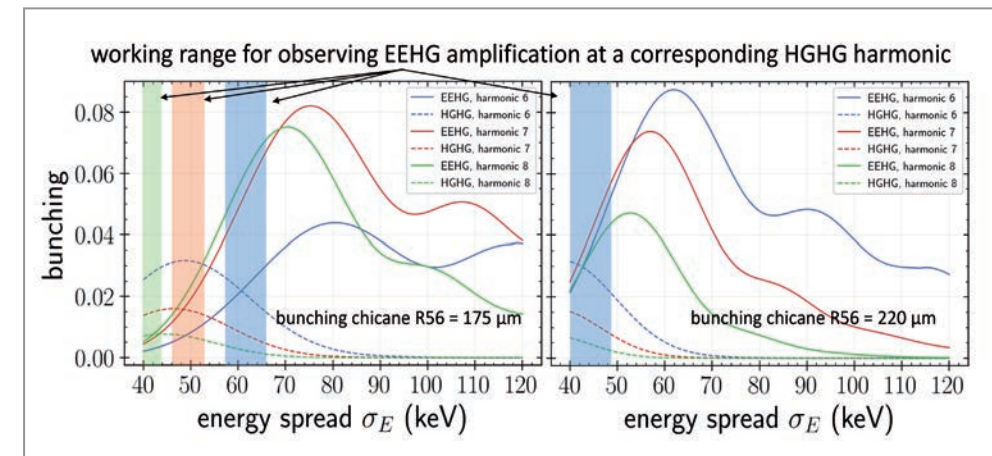

Figure 3

Relative sensitivity of the EEHG and HGHG settings to the initial energy spread for the same modulation amplitudes in the Xseed modulators ( $A_1 = 1$ ,  $A_2 = 3$ ) and the same  $R_{56} = 950 \mu\text{m}$  in the oversharing chicane.

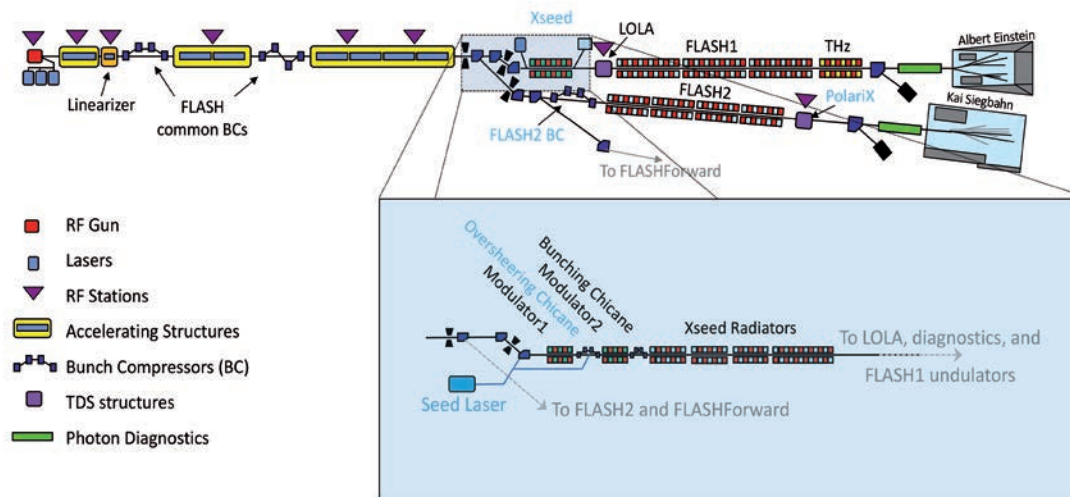

Figure 1

Schematic representation of the FLASH beamlines with enlargement of the Xseed section. The most recently upgraded elements that have contributed to the successful demonstration of parallel operation of SASE and external seeding at FLASH are highlighted in blue.

to tenth harmonic of the 266.7 nm seed laser in both modulator-chicane segments was successfully established, indicating that all the technical and engineering efforts to overlap the electron and laser beams in both segments were effective.

The first attempt at EEHG, however, yielded unexpected results. Instead of an amplification of the signal, a reduction of the signal level was consistently observed. Further work based on analytical approximation explained the results. For the same strength of the oversharing chicane, measured in a parameter called  $R_{56}$ , the strength of the bunching chicane has to be adjusted correctly based on the initial energy spread to allow for both HGHG and EEHG

(Fig. 3). This setting would yield optimised bunching, and higher power of the laser in the first modulator would maximise the EEHG signal.

The time of the current FLASH shutdown is being used for multiple improvements that will allow us to successfully demonstrate EEHG in the next experimental campaigns. Theoretical and simulation work taking into account the control over the electron beam energy spread offered by the new laser heater to be installed in 2022, as well as work on an improved seed laser, are in progress.

Contact: Pardis Niknejadi, [pardis.niknejadi@desy.de](mailto:pardis.niknejadi@desy.de)  
Lucas Schaper, [lucas.schaper@desy.de](mailto:lucas.schaper@desy.de)



# In-depth understanding of seeding

Supporting experimental work on seeding at FLASH through simulations and analytical studies

In the extreme-ultraviolet (XUV) and soft X-ray wavelength ranges, external seeding techniques significantly improve the longitudinal coherence of free-electron lasers (FELs) by initiating the amplification process with coherent light pulses from an external source and prebunching the electron beam before it has entered the radiators. To reach the 4 nm spectral range, the FLASH2020+ upgrade of DESY's FLASH FEL facility foresees the use of two UV laser beams in an echo-enabled harmonic generation (EEHG) scheme, with the aim to lase at the 75<sup>th</sup> harmonic of the seed laser wavelength. Several effects can smear EEHG bunching at such high harmonics, and the imperfection of the seed lasers can also have undesired consequences. Dedicated start-to-end simulations, optimisation scans with ideal or semi-ideal electron beams as well as analytical calculations significantly support current and future external seeding R&D at FLASH.

## Progress towards start-to-end simulations

Even though the transit time of electrons travelling down the FLASH accelerator at almost the speed of light is relatively short, many effects can strongly influence the accelerator's performance. Modelling the process of external seeding from the electron source and tracking the electrons to the end of the accelerator by start-to-end (s2e) simulations is essential for understanding the detailed physics of seeding schemes. The s2e efforts at FLASH aim to take advantage of the available global software pool (Fig. 1) together with the abundant computing resources available today compared to the past decades. These simulations allow the impact of instabilities of the electron beam to be studied in detail and include the complexities

inherent to the seed laser pulses. This approach will benefit both current and future seeding R&D efforts at FLASH [1].

Since 1 May 2021, following a successful application for the allocation of computing time, the Jülich Supercomputing Centre has been providing the majority of the resources required for the FLASH seeding simulation efforts.

## Preparing for seeding experiments to come

The Xseed section in the FLASH1 beamline is currently used to verify seeding methods as part of preparations for the FLASH2020+ upgrade. Highlights of 2021 have been high-gain harmonic generation (HGHG) seeding in parallel

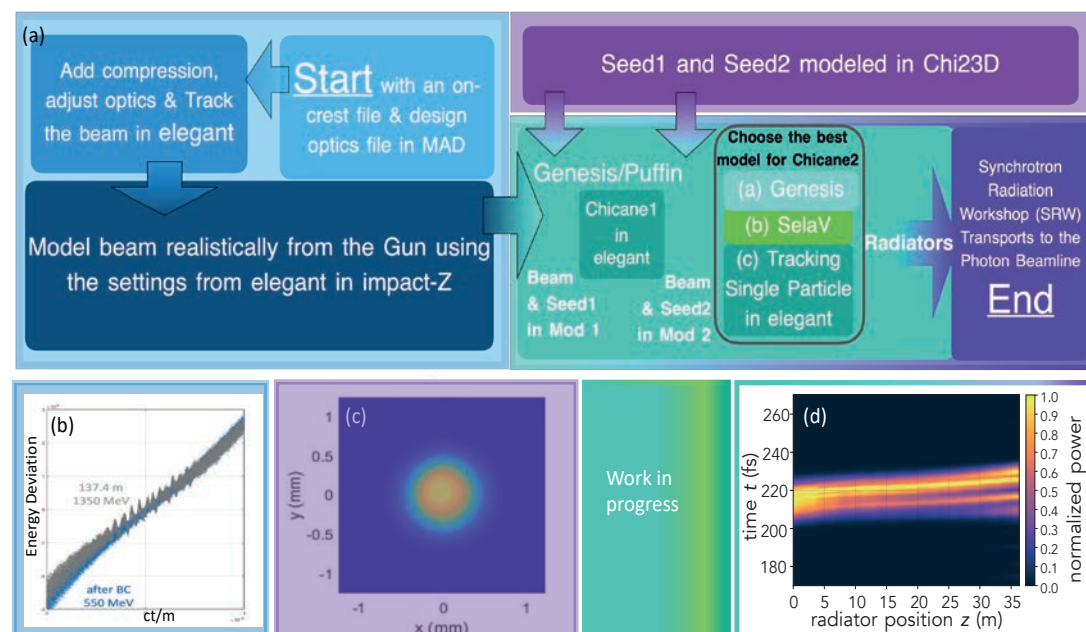

**Figure 1** (a) Planned structure for full s2e simulations, incorporating the three main categories of electron beam, laser seed and output resonant radiation. (b) Example of an electron beam's longitudinal phase space generated and accelerated in a simulation code for electron propagation called impact-Z, showing the microbunching in the beam at two different points in the accelerator. (c) Laser beam profile simulated in Chi23D. (d) Pulse evolution along the radiator beamline simulated in Genesis 1.3v4 with a semi-ideal chirped electron beam.

**Figure 2** HGHG and EEHG bunching maps from analytical calculations [2] at the seventh harmonic for Xseed, which will be relied on for the next beamtimes in 2022/23

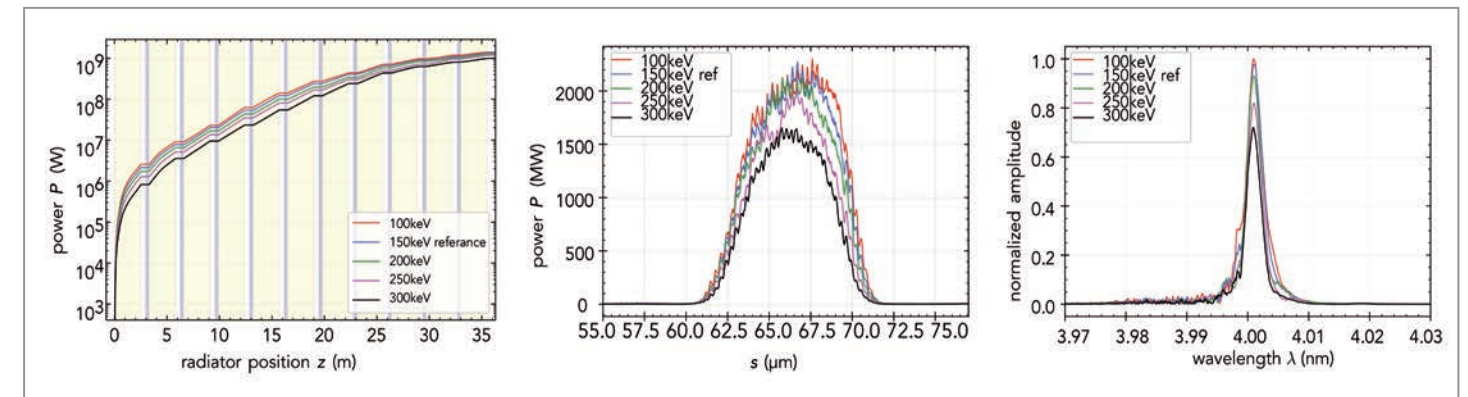
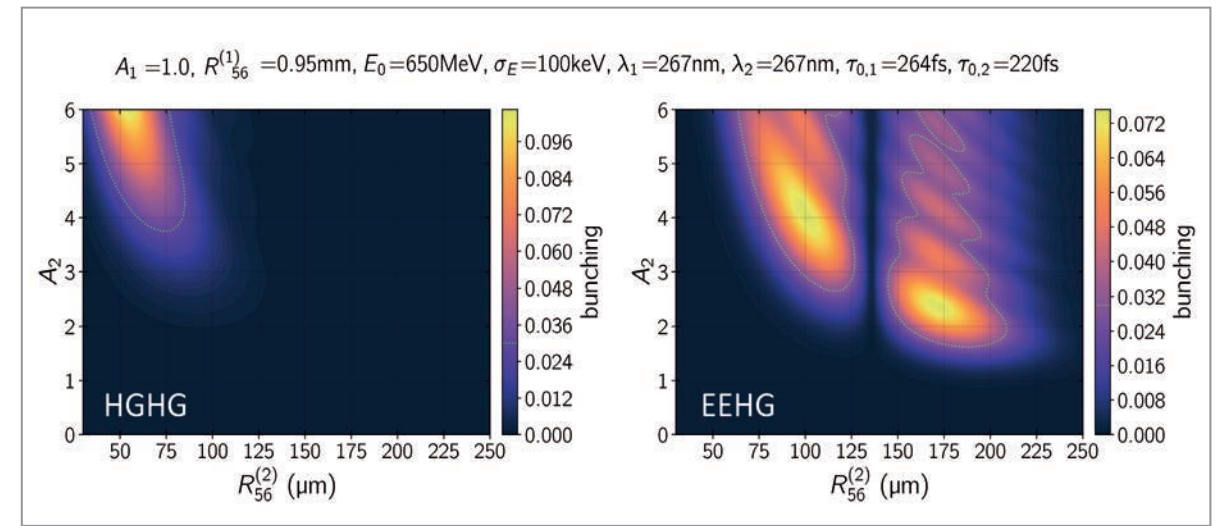

**Figure 3** Sensitivity of an EEHG simulation for 4 nm with tapered radiators to the energy spread at the exit of the linear accelerator. Left: Power increase during propagation over 11 radiators. Centre: Power along the pulse behind the 11<sup>th</sup> radiator. Right: Spectrum at the end of the radiator beamline.

with self-amplified spontaneous emission (SASE) operation in the FLASH2 beamline and HGHG seeding in both modulator segments. The efficiency of HGHG is limited to harmonic numbers up to roughly 20 and hence to longer wavelengths. EEHG allows for much higher harmonics and will thus enable the generation of 4 nm radiation from a 300 nm seed laser after the FLASH2020+ upgrade.

Follow-up experiments are scheduled at Xseed to show EEHG seeding at FLASH for the first time. These experiments need support from extensive simulation efforts. A detailed understanding of "good" working parameters for setup and optimisation is essential. Analytical (Fig. 2) and simulation work supporting these efforts is ongoing for the past and upcoming Xseed experiments.

## Working point optimisation and sensitivity studies for FLASH2020+

Three electron beam energies are required to cover the spectral range anticipated for FLASH2020+. Therefore, optimisation runs with an ideal electron beam have been performed in Genesis 1.3v4 for the EEHG method at 4, 10, 20 and 30 nm. Work on optimising simulations for the

HGHG method (30–60 nm) is ongoing. These simulations also define the design parameters of the APPLE III-type undulators, which offer different variations of polarisation states in the radiators.

Tolerance studies on the electron beam parameters, especially for the 4 nm working point, are crucial to optimise the overall layout. The sensitivity studies performed so far for timing, peak current and energy spread (Fig. 3) were promising. They suggest that any adverse effects due to such variations can be mitigated by properly adjusting the magnetic field in the sequence of radiators – a procedure called tapering. Another ongoing integral sensitivity study is taking into account the electron beam's chirp, a linear variation of the electron beam energy with time (Fig. 1b), which complicates the simulations.

Contact: Pardis Niknejadi, [pardis.niknejadi@desy.de](mailto:pardis.niknejadi@desy.de)  
Lucas Schaper, [lucas.schaper@desy.de](mailto:lucas.schaper@desy.de)

## References:

- [1] L. Schaper *et al.*, *Appl. Sci.* **11**, 9729 (2021)
- [2] N. S. Mirian *et al.*, *Phys. Rev. Accel. Beams* **23**, 060701 (2020)



# Vlasov systems for studying dynamics in free-electron lasers

Vlasov equation from plasma physics extends insight into coherent collective processes in FELs

Optimising the performance of modern free-electron lasers (FELs) requires excellent understanding of the processes that determine the evolution of the beam parameters along the accelerator. The Vlasov equation, known from plasma physics, gives insight into processes that determine the evolution of the phase space density under the influence of the electromagnetic fields generated by the beam itself. DESY's FLASH Accelerator team is studying longitudinal effects in FELs, in particular the so-called microbunching amplification process, analytically and numerically with high resolution and without the inherent artificial noise of macroparticle simulations. The findings are applied within the FLASH2020+ project.

## Vlasov systems

The "beam" – as a large system of completely equivalent, independently and identically distributed charged particles in a particle accelerator – is described by the probability of finding any of the particles inside an infinitesimally small volume in phase space, spanned by the spatial coordinates and conjugate momenta: the phase space density (PSD). The dynamics of such beams is governed by electromagnetic fields from two types of sources: i) the external fields generated by the beamline components and ii) the fields generated by the charged particles themselves. The charge density and the current density, which are the source terms for these self-fields, are easily computed from the PSD by integrating out the momentum degrees of freedom.

With only fields of the first type, the evolution of the PSD is governed by the (linear) Liouville equation. If fields of the second type are considered, the situation changes qualitatively, as the evolution of the PSD now depends on the

PSD itself. This modified non-linear – and by far more complex – version of the Liouville equation is called the Vlasov equation. It describes interactions within the beam on the level of the mean field approximation.

FELs such as FLASH and the European XFEL generally rely on the principle of magnetic bunch compression, which makes it possible to overcome a challenge in the operation of FELs: On the one hand, the FEL process requires very high charge densities at the energy at which it is operated. On the other hand, at low energies, such high charge densities will cause strong repelling space charge forces between the particles, due to which the beam quality will quickly deteriorate. The solution is to generate bunches with an initially moderate charge density and incrementally compress them after they have been accelerated to energies at which the resulting space charge forces are tolerable. Magnetic chicanes are employed to this end. In these, particles with higher energy can overtake

lower-energy particles because they are deflected less strongly and thus take "the inner lane" through the chicane. Combined with a correlation between the longitudinal position and the energy of the particles in the bunch, which is induced by off-crest acceleration, this leads to a compression of the bunch.

As far as longitudinal dynamics are concerned, the linear accelerator of the FEL looks like a sequence of long acceleration units, over which space charge forces act on the beam by modifying the local momentum distribution, and short compression units, on which space charge may be neglected to some extent, but which modify the spatial distribution according to the incoming momentum distribution [1]. In this model, an initial charge density modulation (a "microbunch" structure within the beam) first causes a momentum oscillation, which is then transformed back into a density modulation, potentially adding up to the initial modulation amplitude (microbunching gain). A beam falling apart into many microbunches is potentially extremely destructive to the FEL performance. Note that the simplified model of microbunching described above is in fact solvable in the sense that key quantities such as the microbunching gain can be evaluated with only moderate numerical effort.

## Semi-Lagrangian methods for solving Vlasov systems involving exotic densities

To study less idealised models, simulation codes are required that can give insight beyond the limited features of the analytical models. It is generally agreed that the microbunching effect is predominantly a longitudinal process, so that we may restrict the simulation to the longitudinal phase space. While the traditional approach is to approximate the PSD by a macroparticle ensemble that follows the PSD's distribution law, semi-Lagrangian techniques represent the PSD by interpolation on a two-dimensional grid.

Liouville's principle states that the PSD is preserved along particle trajectories. Hence, one can update to a later representation of the PSD by tracking the phase space coordinates of the grid points backwards in time and interpolating locally using the old PSD grid points neighbouring the back-tracked point. Time steps have to be chosen so that the evolution of the source terms of the field equations does not change too much. Large step sizes can be achieved for systems where the collective force affects only the momentum distribution, but depends only on the spatial distribution. This is true for so-called Poisson kicks. We found a slightly larger class of collective forces with the above-mentioned property [2].

Unfortunately, the longitudinal PSDs typical for FEL applications are rather exotic in the sense that they only populate a very small fraction of their bounding rectangle, so

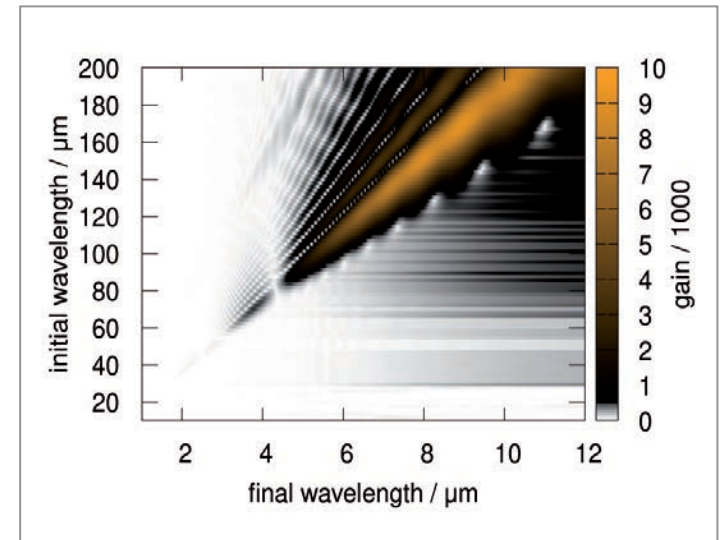

Figure 2 Example of a two-dimensional gain function calculated for FLASH2020+. Higher-order contributions are visible as additional bands next to the main diagonal.

that rectangular grids with high resolution are extremely wasteful in terms of computer memory. We used a tree-based domain decomposition that only requires an actual grid in regions where the beam is sufficiently populated [3]. We implemented these methods in the library libselav and the program SelaV1D [4].

In Fig. 1, the SelaV1D tracking results are displayed for an example close to the solvable model. Figure 2 shows a two-dimensional gain function, i.e. the high-frequency-compressed spectral content of the final PSD as a function of the artificial seed wavelength of the initial PSD for an example relevant to the FLASH2020+ upgrade project. The power of the method becomes clear, since it is generally difficult to observe the higher-order harmonics of the compressed seeding wavelength of the initial charge density modulation.

Especially in the lower-dimensional case, the semi-Lagrangian approach combined with tree-based domain decomposition is a promising, if not superior, alternative to particle-tracking methods, allowing longitudinal collective dynamics to be studied with great precision and at relatively low computational cost.

Contact: Mathias Vogt, [vogtm@mail.desy.de](mailto:vogtm@mail.desy.de)  
Philipp Amstutz, [philipp.amstutz@desy.de](mailto:philipp.amstutz@desy.de)

## References:

- [1] Ph. Amstutz, M. Vogt, Proc. FEL19, THP003 (2019)
- [2] Ph. Amstutz, M. Vogt, Proc. IPAC21, WEPAB226 (2021)
- [3] Ph. Amstutz, M. Vogt, Proc. IPAC18, THPAK138 (2018)
- [4] <https://selav.desy.de/>

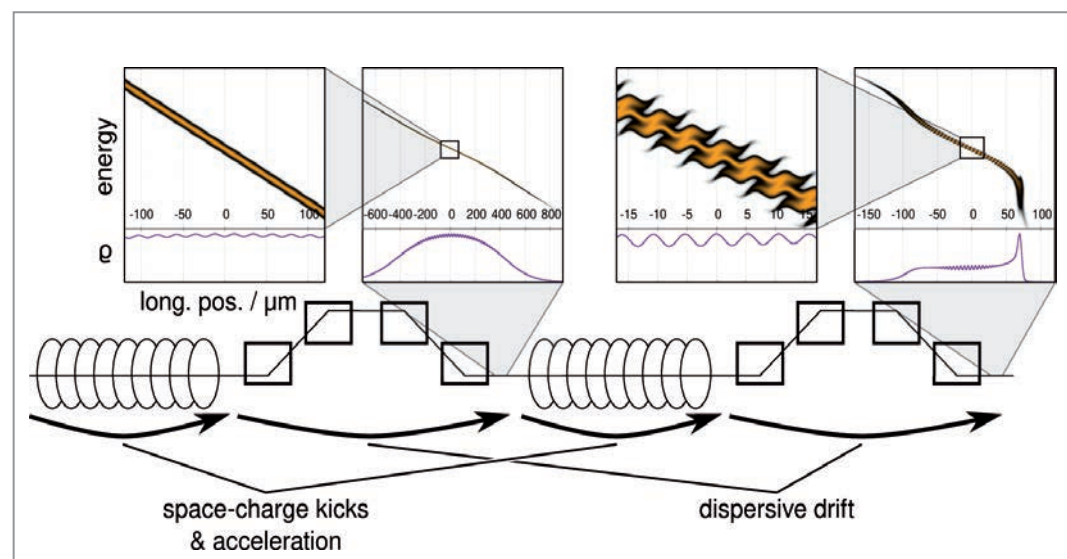

Figure 1 Sketch of the solvable microbunching model for a series of two bunch compression stages, each comprising accelerator modules and a magnetic chicane, together with plots of the phase space density and charge density  $\rho$ . Due to the microbunching mechanism, a small modulation of the initial charge density is converted into intricate substructures in the longitudinal phase space after the second stage.



# High-repetition-rate seeded FEL

Increasing the repetition rate of seeded FEL radiation using existing beamlines

External seed lasers are used at free-electron lasers (FELs) to enable the generation of fully coherent FEL pulses in the soft X-ray regime. Despite the attractive stability and full coherence of seeded FEL radiation, the repetition rate of the FEL radiation is limited by the repetition rate of the seed laser. Instead of relying only on advances of the complex laser systems used in seeding, the work presented here takes advantage of already existing components of seeded FEL beamlines to implement the so-called optical klystron concept, which considerably reduces the peak power requirements of the seed laser. At this significantly lower peak power, the repetition rate of the seed laser can be increased and experiments can immediately benefit from fully coherent and high-repetition-rate FEL radiation.

## Current state of the art and limitations

Self-amplified spontaneous emission (SASE) is currently still a dominant mode of operation at high-gain FELs, as it provides FEL pulses with wavelength tuneability down to hard X-rays and MHz repetition rates at superconducting FELs, such as FLASH at DESY. However, the temporal coherence of SASE radiation is poor because the initiation of the FEL process is based on spontaneous undulator radiation. In addition, the SASE radiation suffers from large shot-to-shot fluctuations. Since a wide range of experiments depends on full coherence and benefits from shot-to-shot stability, new techniques have to take over.

External seeding techniques have already been successfully implemented; they depend on an external seed laser source and provide fully coherent FEL radiation at a harmonic of the seed laser wavelength. While stability and full coherence are given with these methods, the repetition rate of the FEL radiation is limited (to tens of Hz) by the availability of seed laser systems with sufficiently high peak powers in the ultraviolet range. Currently, the upgrade project of FLASH, FLASH2020+, is aiming to develop a novel seed laser system that will provide sufficient peak power for external seeding at 1 MHz in a burst mode. A further increase of the repetition rate of

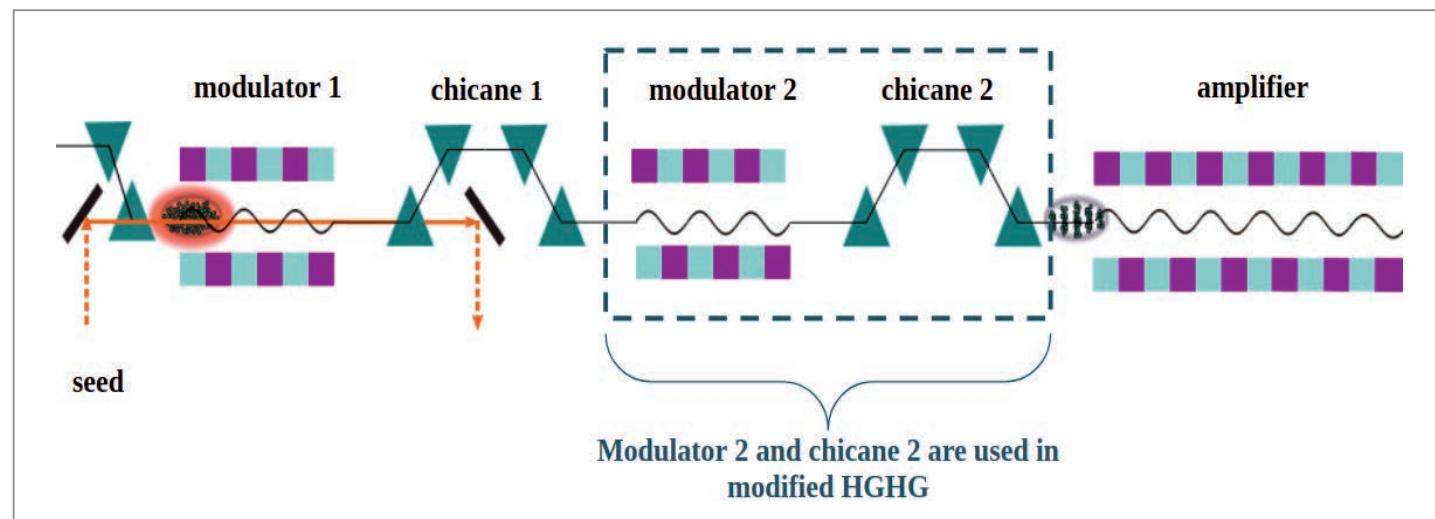

**Figure 1**  
The standard HGHG scheme consists of one modulator undulator, one chicane and an amplifier and requires tens to hundreds of MW seed laser peak power to obtain FEL radiation at harmonics of the seed laser wavelength. By simply using in addition the modulator and chicane (as highlighted in the figure) that already exist in seeded FEL beamlines, the peak power requirements can be reduced by two orders of magnitude, allowing seed laser systems to operate at a higher repetition rate.

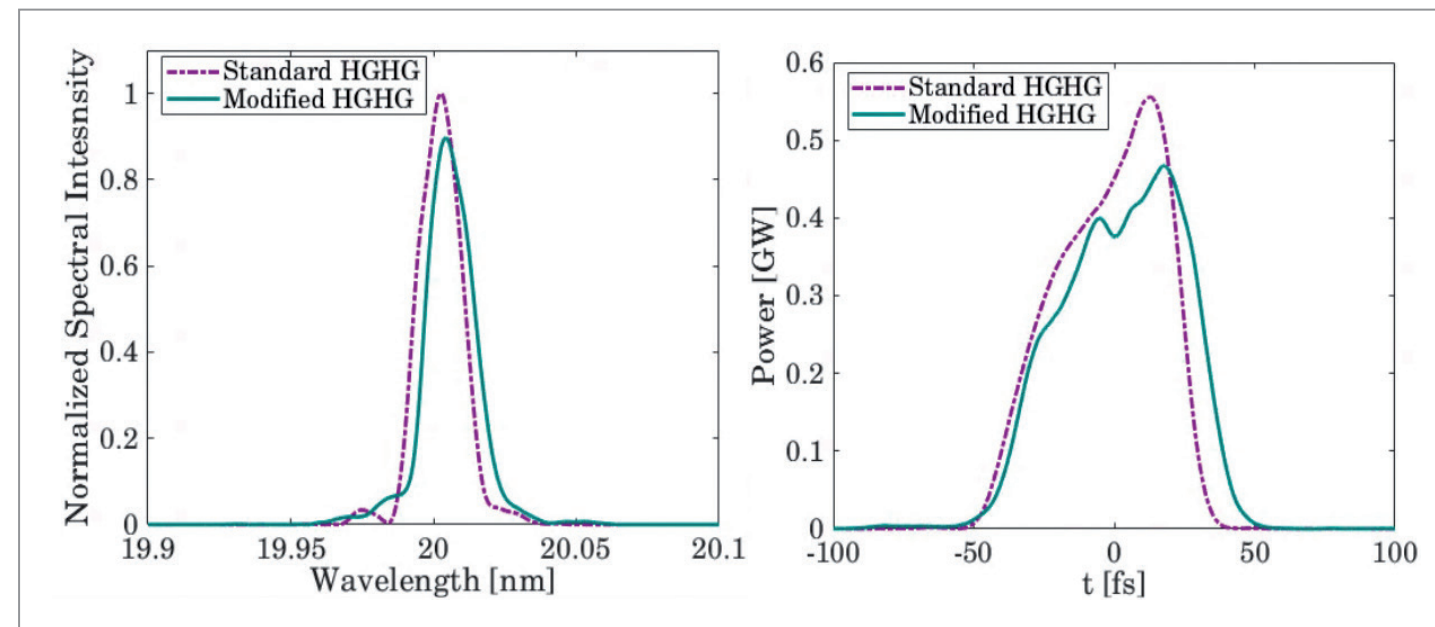

**Figure 2**  
Comparison of the simulated output FEL radiation generated at the 15<sup>th</sup> harmonic of a 300 nm seed laser. A seed laser peak power of 61 MW was used for the standard HGHG scheme, while only 0.17 MW were required for the modified HGHG scheme.

seed laser systems at this wavelength and peak power is, however, not possible with such technology in the near future.

## Increasing the repetition rate of external seeding with no additional installations

To support the advances in seed laser technology towards achieving a high repetition rate, an alternative seeding scheme based on the concept of the optical klystron [1] was simulated. It was shown that, by simply using some additional components already existing in certain seeded FEL beamlines, the seed laser peak power requirements can be reduced by two orders of magnitude [2].

The study was based on FLASH2020+ parameters and the high-gain harmonic generation (HGHG) seeding scheme. Instead of the standard HGHG scheme, consisting of one modulator undulator and one chicane upstream of the amplifier, where a harmonic of the seed laser wavelength is amplified, one more chicane and modulator undulator were used (Fig. 1). This additional chicane and modulator already exist in seeded FEL beamlines, such as the one of FLASH2020+, as they are necessary to implement the echo-enabled harmonic generation (EEHG) seeding scheme.

To verify that comparable results can be obtained with the two schemes, simulations were performed with the Genesis 1.3v4 code, and the FEL radiation was compared at the 15<sup>th</sup> harmonic of a 300 nm seed laser wavelength (Fig. 2).

Both schemes generated FEL radiation at 20 nm characterised by full coherence and comparable bandwidth, peak

power and pulse duration. While in a standard seeding scheme a seed laser peak power of 61 MW was required when interacting with the electron bunch, the modified HGHG scheme reduced the power by a factor of 360, down to 0.17 MW. Such a significant reduction in peak power allows the seed laser system to withstand higher repetition rates. In addition, it becomes possible to use lasers of shorter wavelengths, which are typically available at lower peak powers. In this way, the shortest wavelength generated by HGHG could be extended from the 20 nm assumed here to shorter wavelengths.

## Accelerating science at FELs with high-repetition-rate seeding

High-repetition-rate seeding will allow a wide range of experiments to obtain sufficient statistics, thus accelerating ongoing science at FELs. At the same time, the stability and full coherence of seeded radiation will enable accurate measurements and exciting possibilities that pave the way for new findings and a bright future for FELs.

Contact: Georgia Paraskaki, [georgia.paraskaki@desy.de](mailto:georgia.paraskaki@desy.de)  
The presented work was performed in collaboration with E. Allaria, E. Schneidmiller and W. Hillert [2].

## References:

- [1] N.A. Vinokurov, A.N. Skrinsky, Preprint of INP 77-59 (1977)
- [2] G. Paraskaki, E. Allaria, E. Schneidmiller and W. Hillert, Phys. Rev. Accel. Beams 24, 120701 (2021)



# Mixture of lasing schemes for tricky experiments at FLASH

Combining a harmonic-lasing self-seeded FEL with two-colour lasing

DESY's FLASH free-electron laser (FEL) facility can produce self-amplified spontaneous emission (SASE) FEL pulses in the extreme ultraviolet to soft X-ray region. The flexibility of the variable-gap undulators in the FLASH2 beamline opens up a wide range of scientific opportunities. Different advanced lasing schemes have been tested in the past years, such as the frequency doubler scheme, two-colour lasing and the harmonic-lasing self-seeded (HLSS) FEL scheme. In 2021, a user experiment required parameters not yet provided at FLASH: a similar power in the fundamental and the third harmonic of the photon wavelength. Thanks to a trick, combining HLSS and two-colour lasing, a tailored two-colour beam could be delivered to the user experiment.

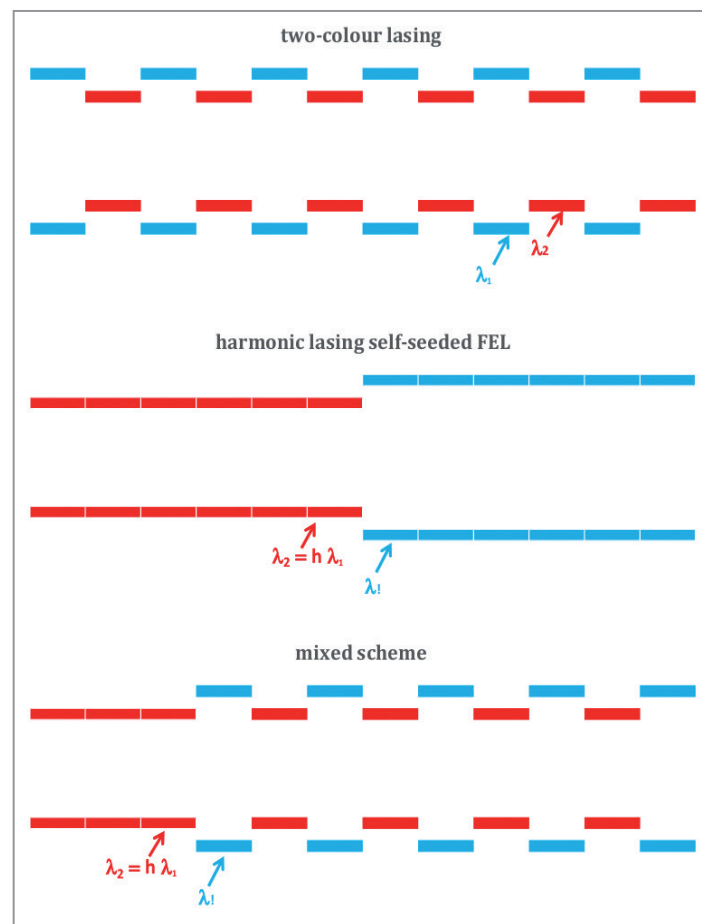

**Figure 1**  
Tuning of the gaps of the undulator segments in the two-colour lasing scheme, the HLSS scheme and a mixed scheme used to optimise the setup to meet special experimental requirements

## Choice of appropriate lasing scheme

The FLASH2 undulator beamline contains 12 variable-gap undulator segments with a length of 2.5 m each. The tuneable gap allows the undulator parameter  $K$  and thus the lasing wavelength to be controlled in a certain range, depending on the electron beam energy. In addition to SASE operation at varying wavelength, different lasing schemes are used to increase the photon parameter space. As every experiment has its own requirements on photon pulse properties and its own demands on quality and stability, the FLASH team optimises each individual setup to provide all the requested parameters.

Some photon experiments require two different soft X-ray wavelengths. Depending on the demands of the experiment, different schemes might be the best choice, such as the frequency doubler scheme, the HLSS scheme [1, 2] or two-colour lasing with different configurations. For two-colour lasing, a scheme based on alternating tunes of the undulator segments was found to be beneficial [3]. Figure 1 shows a schematic of the setup for two-colour lasing based on alternating tunes (top) and HLSS (middle). The HLSS scheme does not rely on the third harmonic of the fundamental, but produces the third harmonic from the "seed" directly – and thus with high power.

For a user experiment analysing the relaxation time scales in core-level photoexcited molecules, lasing at 17.7 nm and 5.9 nm in parallel, both at full power, was required. Additionally, wavelength scanning in a small

range and FEL pulse durations shorter than 50 fs in a bunch train of 40 bunches with 100 kHz repetition rate were asked for. On the one hand, previous studies at FLASH had shown that the FEL pulse energy in a HLSS configuration exceeds conventional SASE by 50% [1], so HLSS seemed to be a good choice. Unfortunately, the fundamental wavelength is eroded in this scheme and cannot be transported to the photon experiment since the focal points of the two different colours are far away from each other. On the other hand, two-colour lasing based on alternating tunes offers the possibility to generate the focal point of both wavelengths close to each other, but it does not use the third-harmonic relation of the two wavelengths to each other and hence lacks the high output power in the third harmonic.

Therefore, the FLASH team decided to use a mixture of both configurations, shown in Fig. 1 (bottom). The first three undulators were tuned to 17.7 nm to allow the fundamental wavelength to gain intensity and to develop third-harmonic generation. Afterwards, two-colour lasing based on alternating tunes was applied to increase the intensity of the fundamental and the third harmonic and to get a source and hence later also a focal point at a similar position.

## Pulse properties

Two-colour operation was performed at an electron beam energy of 1.04 GeV, providing wavelengths of 5.9 nm and 17.7 nm. Using the mixed undulator configuration, a

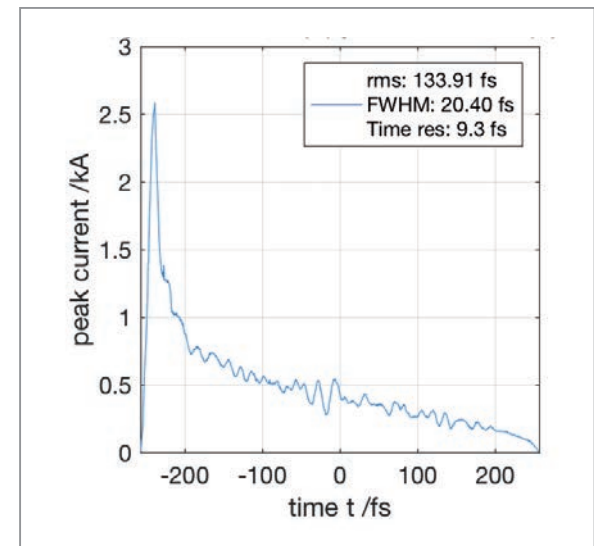

**Figure 2**  
Current density of the electron bunch measured using the PolariX TDS. The measurement was performed during lasing with 3  $\mu$ J at 5.9 nm and 26  $\mu$ J at 17.7 nm using the mixed undulator configuration shown in Fig. 1 (bottom).

photon pulse energy of about 3  $\mu$ J at 5.9 nm and 30  $\mu$ J at 17.7 nm was achieved. The photon pulse energy was measured using different gases in two X-ray gas monitor detectors with known cross sections. In order to achieve the required photon pulse duration below 50 fs, the bunch charge was reduced to 250 pC and measurements using a transverse deflecting structure (TDS) were performed to characterise the FEL pulse. Figure 2 shows the measurement of the current density distribution of a lasing bunch, done after finalising the setup. The bunch had a high peak current. After an initial resonance scan, both wavelengths were fixed and could be provided very stably.

Contact: Juliane Rönsch-Schulenburg,  
juliane.roensch@desy.de  
Siegfried Schreiber, siegfried.schreiber@desy.de

## References:

- [1] E. A. Schneidmiller, M. V. Yurkov, Proc. FEL2013, WEPS078 (2013)
- [2] E. A. Schneidmiller *et al.*, Phys. Rev. Accel. Beams 20, 020705 (2017)
- [3] E. A. Schneidmiller *et al.*, Proc. FEL2019, TUP055 (2019)



# PolariX advances FLASH2

Longitudinal phase space measurement with femtosecond resolution

Transverse deflecting radio frequency (RF) structures (TDSs) are state-of-the-art longitudinal diagnostic hardware for beams of very short particle bunches with lengths in the range from several to several hundreds of micrometres. The PolariX X-band (12 GHz) TDS is a project between CERN, PSI and DESY [1]. A first prototype was installed in the beam-line of the FLASHForward plasma wakefield acceleration experiment in 2019 [2], commissioned and successfully used within the experimental programme. In early 2021, a new PolariX consisting of two RF structures was installed in the FLASH2 beamline together with an upgrade of the RF system shared by the FLASH2 and FLASHForward PolariX structures. The FLASH Accelerator team started conditioning the system and routinely used the new PolariX for self-amplified spontaneous emission (SASE) tuning and other related free-electron laser (FEL) studies at FLASH2.

## The physics behind TDS-based longitudinal diagnostics

Optimising the performance of sophisticated accelerator applications like FELs generally requires excellent knowledge of the longitudinal distribution of the electron bunch parameters. If the bunches are short, in the femtosecond range, traditional electronic detectors do not offer enough bandwidth to resolve substructures inside the already

short bunches. A TDS is an RF structure with an eigenmode that has a transverse electric field component and thereby deflects particles transversely depending on their arrival time with respect to the RF wave. It can be used as a fast kicker or a very powerful streaker. In the latter case, the streaked bunch evolves through a beamline with a given optics and thereby maps the initial longitudinal position inside the bunch onto a transverse position in the streak plane. A screen is positioned at this location so that the longitudinal coordinate translates to a transverse position on the screen along the axis of the streak plane.

High amplitudes of the electric field and high RF frequency both enhance the displacement on the screen and thus the resolution. If the beamline upstream of the TDS builds up transverse energy dispersion at the screen, like in a magnetic spectrometer, and the dispersive plane is perpendicular to the streak plane, the complete longitudinal phase space is mapped onto transverse positional space (x-y space). If such a TDS with dispersive beamline is

Figure 1

PolariX measurements with undulators open (top) and closed (bottom). Left: Phase space density. Right: Current density. The open-undulator case shows weak microbunching, while the closed-undulator case exhibits sharp current spikes and an enhanced local energy spread in the region around -200 fs, indicating that this region supported the actual SASE process.

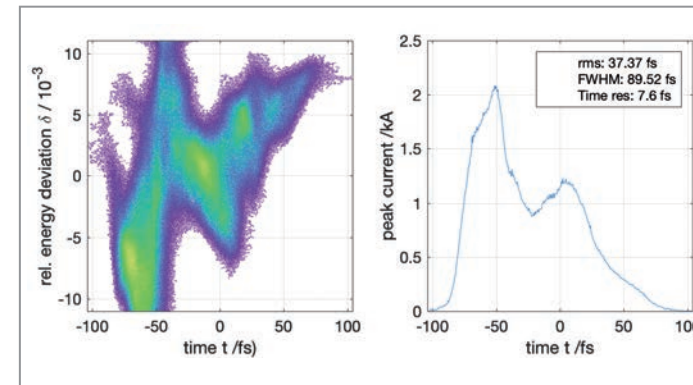
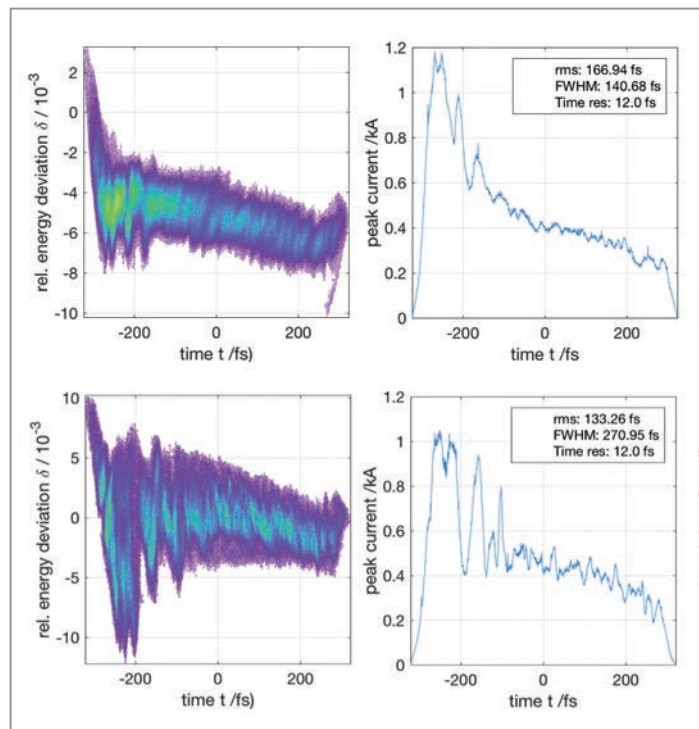

Figure 2

PolariX measurement during tuning for setup of a user experiment. Left: Phase space density. Right: Current density. The temporal resolution was optimised to 7.6 fs (2.3  $\mu\text{m}$ ) so that the short bunch almost fills the entire screen.

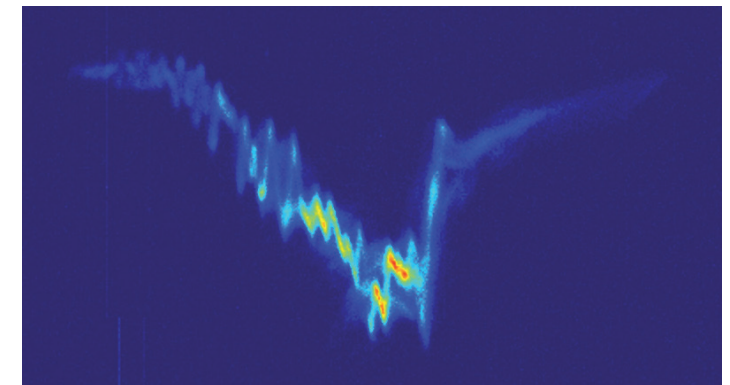

Figure 3

PolariX image of the longitudinal phase space density for an exotic, heavily microbunched bunch observed during dedicated microbunching studies

placed downstream of an FEL undulator, the longitudinal portion of the bunch that actually supported the FEL process can be determined, and thus to some extent also the photon pulse duration of the FEL pulse. Exactly this scheme has been realised at FLASH2.

## PolariX – novel TDS design with variable polarisation

The PolariX is an X-band (12 GHz) TDS with the essential new feature that the polarisation of the transverse electric field can be varied by tuning the relative phases of two perpendicular in-coupling ports of the structure. This feature enables measurements of the longitudinal distribution of emittance and mismatch in both transverse planes and even phase space tomography [3]. At FLASH2, the only feasible and reasonable location for the PolariX is downstream of the SASE undulators and close to the beam dump. This implies strong constraints on the beam optics, so that even after efficient optimisation a fully satisfactory temporal resolution can only be achieved with a significantly larger streaking amplitude than needed for the FLASHForward PolariX. Therefore, a design with two RF structures was chosen, and an RF pulse compressor was installed to increase the peak RF power, targeting 20 MW for 100 ns RF pulse duration.

A “fresh” RF system needs conditioning to enable operation with high power without electric breakdowns. The tedious conditioning is still ongoing. Nevertheless, a power level of 6 MW for 100 ns has already been reached, equivalent to what has been achieved at the FLASHForward

PolariX. This is not yet optimal, but sufficient to perform phase space mappings with an already very good resolution below 10 fs.

## Applications of PolariX

Since mid-2021, the PolariX at FLASH2 has been routinely used for beam tuning for user experiments as well as for dedicated studies of electron beam dynamics and FEL processes. Figure 1 shows two bunches that have been set up almost identically, except that one (top) was measured with open undulators, while the other (bottom) was measured with closed undulators and 250  $\mu\text{J}$  SASE pulse energy at 21 nm wavelength. Figure 2 shows a bunch prepared for user operation with short pulses. Note the very good temporal resolution of 7.6 fs. Figure 3 is an exotic example of a heavily microbunched bunch observed during dedicated microbunching studies, demonstrating the power of the instrument for those studies.

Contact: Mathias Vogt, [vogtm@mail.desy.de](mailto:vogtm@mail.desy.de)  
Juliane Rönsch-Schulenburg, [juliane.roensch@desy.de](mailto:juliane.roensch@desy.de)  
Siegfried Schreiber, [siegfried.schreiber@desy.de](mailto:siegfried.schreiber@desy.de)

## References:

- [1] P. Craievich *et al.*, Phys. Rev. Accel. Beams 23, 112001 (2020)
- [2] R. D'Arcy *et al.*, Philos. Trans. R. Soc. A 377, 20180392 (2019)
- [3] D. Marx *et al.*, Sci. Rep. 9, 19912 (2019)



# RF waveguide distributions for FLASH2020+

Development, design and production of waveguide distributions for the FLASH upgrade

DESY's FLASH free-electron laser (FEL) facility consists of a 1.3 GHz radio frequency electron source (RF gun) and seven 12 m long TESLA-type superconducting accelerator cryomodules (ACC) containing eight accelerating cavities each. Five RF stations with 5 MW or 10 MW klystrons supply the cryomodules with RF power through a waveguide distribution system. To realise the FLASH2020+ upgrade project, more than 80% of the waveguide distribution system needs to be modified and optimised.

## Development of waveguide distributions for FLASH2020+

To achieve the shorter wavelengths foreseen for the FLASH2020+ upgrade by increasing the energy of the accelerator, new accelerator modules will be installed. The waveguide distributions for the modules have to be modified to reach the maximal accelerating gradient for each superconducting cavity, which requires a cavity power ranging from 142 kW to 387 kW.

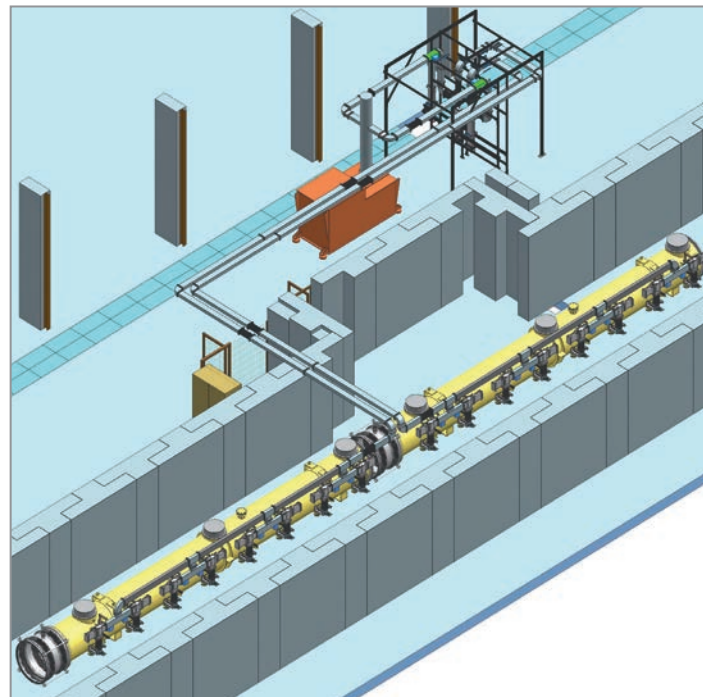

Figure 1  
Design of the waveguide distribution between the RF station 1 and the accelerator modules ACC2 and ACC3

RF waveguide distributions deliver the RF power generated by the klystrons of the RF stations to the individual cavities of the accelerator. During the winter shutdown 2021/22, all five RF stations will be upgraded, two of them completely renewed, and the waveguide distributions will be modified to meet the requirements of the new modules. Figure 1 shows the layout of the RF waveguide distribution between the RF station 1 and the accelerator modules ACC2 and ACC3.

The klystron and connecting waveguide distributions for the RF stations 1, 4 and 5 and the waveguide distributions for the cryomodules ACC2, ACC3, ACC4 and ACC5 were developed, designed and tuned in the Waveguide Assembly and Test Facility (WaveATF). All key waveguide components, such as isolators, directional couplers and fixed phase shifters, were tested on the WaveATF high-power RF (HPRF) test stand (Fig. 2). All the components for each cryomodule were tested and tuned separately before the complete waveguide distribution for each module was checked on the WaveATF low-level RF (LLRF) test stand (Fig. 3). During the LLRF test, the coupling ratio and the phase were tuned for each cavity. The input standing wave ratio (SWR) and the dynamic phase range were also optimised.

To reduce the installation time in the FLASH tunnel, the waveguide distributions for the cryomodules ACC2 and ACC3 were mounted directly onto the cryomodules in the Accelerator Module Test Facility (AMTF). The installation of ACC4 and ACC5 in the FLASH tunnel will be finished in spring 2022. The SWR of the entire system is largely determined by the isolators, which have an SWR of <1.2 under operating conditions. The complete waveguide

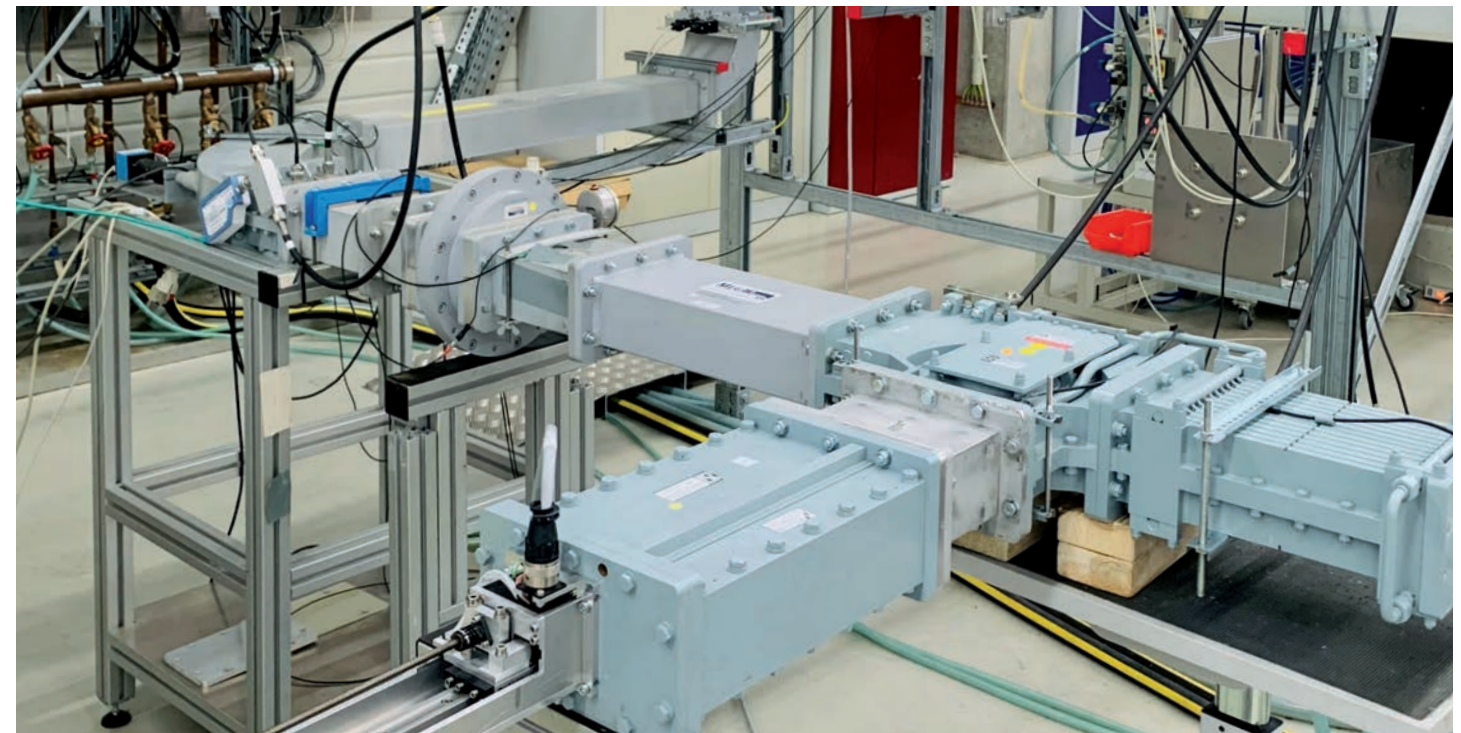

Figure 2  
Isolator on the HPRF test stand



Figure 3  
Complete waveguide distribution for one module on the LLRF test stand

distribution systems were produced with a coupling ratio accuracy of 0.2 dB for each cavity with a maximum input SWR of 1.2.

A particularly high degree of accuracy was required when setting the phase. Since the modules have different space between the cavities (European-XFEL-type vs. FLASH-type), the phase tuning was especially important and difficult to manage. The installation of all the klystron

waveguide distributions will be realised without the use of sulphur hexafluoride ( $\text{SF}_6$ ). Airflow machines will be used as a much more reliable and efficient alternative. In addition, all RF switches will be coded to ensure safe and monitored handling.

Contact: [Burcu Yildirim, burcu.yildirim@desy.de](mailto:Burcu.Yildirim@desy.de)  
[Stefan Choroba, stefan.choroba@desy.de](mailto:Stefan.Choroba@desy.de)



# Photocathodes at FLASH

Cs<sub>2</sub>Te photocathodes with high quantum efficiency and long lifetime

The electron beam of DESY's FLASH free-electron laser (FEL) facility starts at the photocathode – point zero. As a high-duty-cycle machine, FLASH accelerates thousands of electron bunches per second. Only a cathode with high quantum efficiency (QE) can meet this requirement, and high QE over a long time is an asset for a user facility. Over the past years, the caesium telluride (Cs<sub>2</sub>Te) photocathodes in operation at FLASH have demonstrated remarkably high QE, low dark current and long lifetime.

## Cs<sub>2</sub>Te cathodes at DESY

The photocathode installed at FLASH is a thin film of Cs<sub>2</sub>Te on a molybdenum plug inserted from the back into the radio frequency (RF) electron source (gun). A laser system perfectly synchronised to the RF field of the gun sends bursts of picosecond-long ultraviolet (UV) laser pulses to the cathode. Through the well-known photoelectric effect, each laser pulse generates an electron bunch. The parameters of the RF gun as well as the laser spot size and pulse duration are adjusted so as to generate an electron beam with high brilliance.

The choice to use Cs<sub>2</sub>Te cathodes at FLASH goes way back to the CLIC Test Facility at CERN and the TESLA Test Facility at DESY, with other labs also joining in the use of Cs<sub>2</sub>Te.

In cooperation with INFN LASA in Milano, Italy, such cathodes were already produced in 1997. At DESY, a cathode lab was set up in 2007 to manufacture cathodes for FLASH, the PITZ photoinjector test facility and the European XFEL X-ray laser. Nowadays, it also serves DESY's REGAE ultrafast electron diffraction facility and the ARES linear accelerator. The lab is currently being extended for further cathode research (Fig. 1), especially in view of a continuous-wave (CW) operation of electron sources.

As the cathodes are sensitive to pollution, they have to be kept in ultrahigh vacuum at all times. The cathodes used in the last years at FLASH were produced at INFN LASA in 2013 and at DESY. This shows that it is indeed possible to store such cathodes for many years.

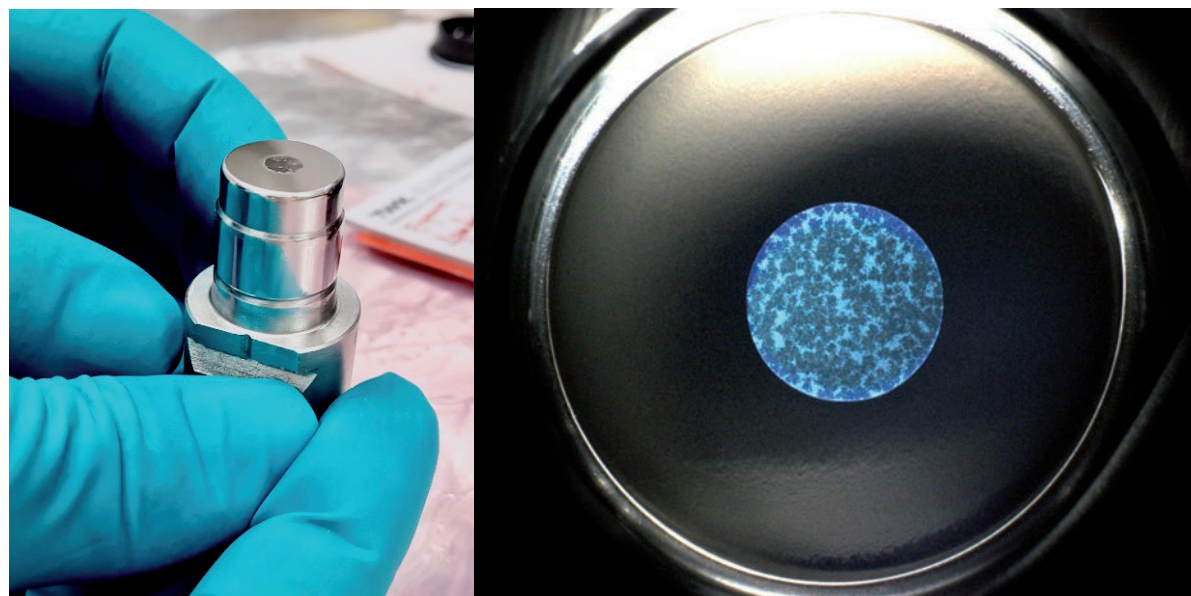

**Figure 1**  
Left: Example of a FLASH Cs<sub>2</sub>Te photocathode designed, produced and analysed in the cathode lab at DESY.  
Right: Active area of the Cs<sub>2</sub>Te photocathode after deposition on the molybdenum plug (front view, plug diameter 16 mm, cathode diameter 5 mm).

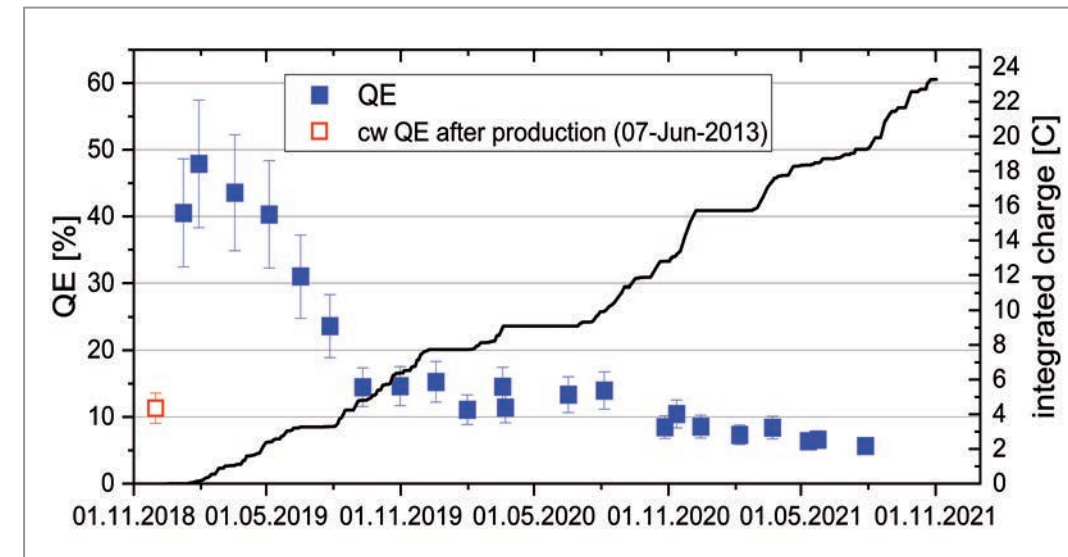

**Figure 2**  
Quantum efficiency (QE) of the photocathode #105.2 presently in operation at FLASH. The red square indicates the QE measured in the lab after production. The blue squares are the QE measurements performed in the electron RF gun. As of November 2021, a charge of 23 C has been emitted (black line).

## Quantum efficiency

The QE is defined as the ratio of the number of electrons emitted from the cathode to the number of photons impinging on it. The spectral response, i.e. the QE as a function of photon energy, was measured in the DESY cathode lab with a high-pressure mercury lamp scanning the photon energy from 3 to 5 eV (see annual report *DESY Accelerators 2016*). From these measurements, we deduced a work function of 3.5 eV, in agreement with the literature. This also revealed that the optimal laser photon energy in terms of high QE should be around 5 eV. FLASH uses two lasers based on Nd:YLF (1047 nm) and one based on Yb:YAG (1030 nm), with the fourth harmonic at 262 nm and 257 nm, respectively, corresponding to about 4.7 eV.

Figure 2 shows the QE of the photocathode #105.2, which has been installed in the FLASH RF gun since December 2018. QE measurements have been performed continuously at regular intervals. The RF gun is operated at its nominal RF power of 4.7 MW and at an RF phase of 38° off zero crossing. Zero crossing refers to the phase between the laser and the accelerating field through which electrons can be emitted and transported out of the RF gun. At 40% to 50%, the initial QE in operation in the RF gun was much higher than the QE measured right after production. The cathode had been stored for 4.5 years under ultrahigh vacuum and had apparently maintained good surface properties. During operation in the RF gun, the surface layer of the cathode changed, reducing the QE quickly to around 15% (September 2019). Afterwards, a balance of degradation and regeneration by the UV laser during operation stabilised the QE at 15% (until August 2020) and later at 6%. As of November 2021, a total charge of 23 C has been emitted from this cathode.

The previous cathode #73.2 was operated for 1413 days from January 2015 to December 2018 with an average QE of about 8% and a total emitted charge of 25 C.

## Summary and outlook

All in all, the Cs<sub>2</sub>Te photocathodes in operation at FLASH show a remarkably high QE and long lifetime – no lifetime issues have occurred with Cs<sub>2</sub>Te cathodes over the last years. In order to maintain this outstanding performance, several improvements have been made. One example is a significant design change of the cathode transfer system. The new design not only facilitates compatibility and the handling of the photocathodes on different systems, but also features a very soft movement of the cathode holder during cathode transfers. The reduction in particles contaminating the systems that resulted from these improvements is significant and one of the reasons why FLASH and the European XFEL operate with low dark current.

Within a collaboration between DESY in Hamburg, PITZ at DESY in Zeuthen and INFN LASA in Milano, an extension of the cathode lab at DESY will contribute to the development of cathodes with a high QE for green laser wavelengths. This kind of cathode would be an asset for CW-operation electron sources.

Contact: Pavel Juarez, [david.pavel.juarez.lopez@desy.de](mailto:david.pavel.juarez.lopez@desy.de)  
Sven Lederer, [sven.lederer@desy.de](mailto:sven.lederer@desy.de)  
Siegfried Schreiber, [siegfried.schreiber@desy.de](mailto:siegfried.schreiber@desy.de)



# Plasma accelerators recover in a FLASH

FLASHForward takes first step towards defining repetition rates of plasma-based facilities of the future

The GV/m accelerating gradients inherent to beam-driven plasma accelerators may hold the key to unlocking cost-effective accelerators, facilitating the acceleration of particle bunches to higher energies over shorter distances than is possible today with conventional facilities. However, in order to meet the luminosity and brilliance demands in high-energy physics and photon science, the plasma accelerators of the future must be capable of accelerating thousands of high-intensity bunches per second – many orders of magnitude more than the current state of the art. The first step towards answering whether or not plasma accelerators can meet this lofty goal is to define the minimum possible separation between acceleration events permitted by the fundamental physics of long-term plasma evolution. The many-nanosecond-level recovery time measured for the first time at DESY's beam-driven plasma acceleration facility FLASHForward establishes the in-principle attainability of MHz acceleration rates in plasma.

## Repetition rates of modern accelerators

The luminosity and brilliance demands in high-energy physics and photon science make the amount of accelerated charge per second a key metric for many state-of-the-art particle accelerators. In practical terms, this means optimising the temporal pattern of particle bunches for the chosen accelerator technology such that thousands of bunches may be accelerated per second. For example, in radio frequency (RF) accelerators, the bunch train pattern is often composed of long bursts of bunches with nanosecond to microsecond inter-bunch separations.

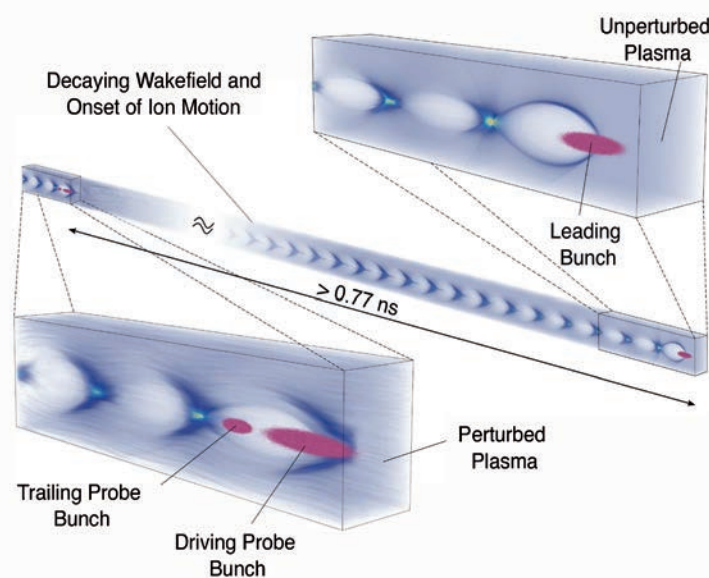

Figure 1  
Conceptual representation of the plasma probe process. The rendering was performed using VisualPIC [1].

Plasma wakefield accelerators represent a disruptive development in accelerator technology due to their promise of multi-GV/m accelerating gradients – orders of magnitude higher than those achievable with RF. However, if this technology is to meaningfully compete with conventional technology in terms of luminosity and brilliance, it must also be capable of accelerating many particle bunches per second. The first step in addressing the feasibility of this challenge is to define the fundamental building block of repetition rate: the minimum possible separation between two bunches.

## Probing the plasma

The electromagnetic fields in plasma, unlike those in RF cavities, are significantly damped after only a few oscillations, at which point the plasma wake collapses. Therefore, it is essential to utilise the first oscillation of the wakefield for acceleration, then wait for the perturbed plasma to recover to approximately its initial state before the next acceleration. This recovery time places an upper limit on the maximum achievable repetition rate of plasma accelerators. A diagnostic technique analogous to pump-probe methodology (Fig. 1) has been developed at FLASHForward to ascertain for the first time the evolution and recovery time of the plasma with sub-nanosecond resolution.

## Dynamics of long-term plasma evolution

After the leading bunch drives a wakefield in the unperturbed plasma, the perturbed plasma can be sampled with a series of later-arriving probe bunches. By analysing the energy spectra and transverse distributions of the probe

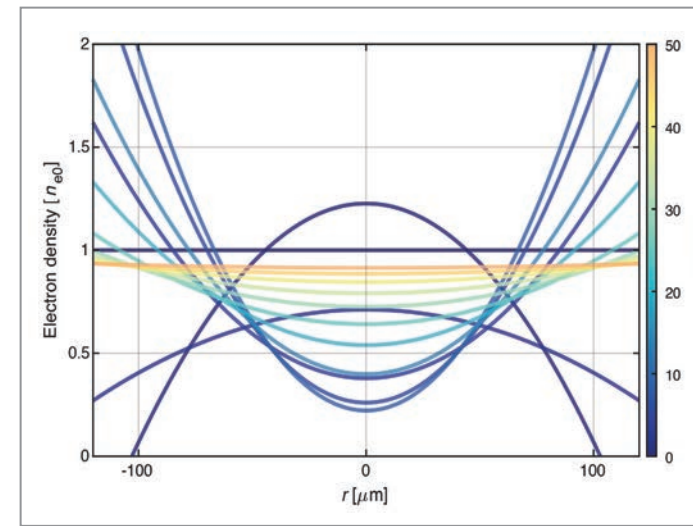

Figure 2  
Experimentally derived radial plasma density profile as it evolves in time after the leading bunch has driven a wake.

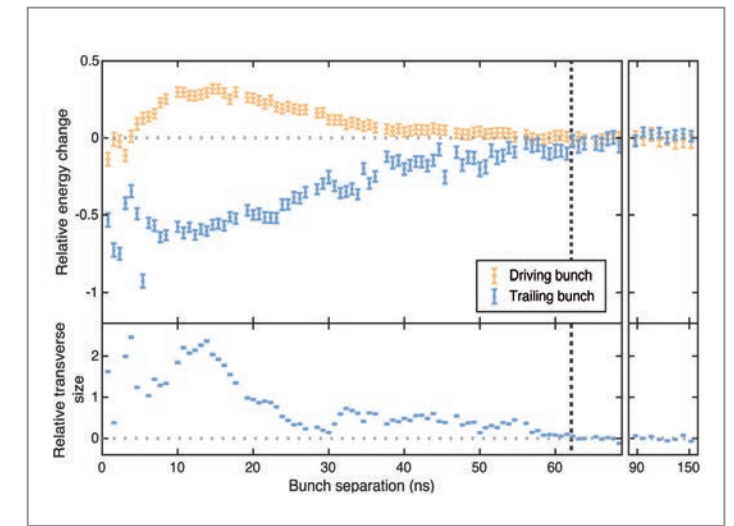

Figure 3  
Residuals between energy spectra and transverse bunch size of both unperturbed and perturbed probe bunches. The vertical dashed line indicates the point of recovery of the plasma.

bunches, it becomes possible to understand how the plasma evolves in time. Figure 2 shows the experimentally derived radial plasma density profiles from 0.77 to 50 ns after the first wakefield has been driven.

At the very shortest times, an on-axis density peak develops, indicating that the homogeneous background of plasma particles has been drawn towards the axis of the leading bunch due to its extremely high transverse fields. In the subsequent nanoseconds, this peak evolves into a density trough as the electrons and ions impelled towards the leading bunch cross paths and continue off axis. At later times, the on-axis deficit of plasma particles starts to decrease due to an inwardly moving ion-acoustic wave of colder plasma particles until a flat, homogeneous background of plasma is reestablished.

## Recovery time of a plasma accelerator

The recovery time of the plasma is defined as the point at which the properties of the probe bunches after interaction with the *perturbed* plasma are consistent with those measured after interaction with an *unperturbed* plasma, i.e. in the absence of the leading bunch (Fig. 1). For the case at FLASHForward – using an argon plasma of density  $1.75 \times 10^{16} \text{ cm}^{-3}$  – all experimental observables indicate that the properties of the probe bunches are consistent to within errors by 63 ns after perturbation of the plasma by the leading bunch (Fig. 3).

The recovery time for this operational state therefore translates to an upper limit of the inter-bunch repetition

rate of  $O(10 \text{ MHz})$  [2]. In principle, plasma accelerators are therefore capable of accelerating millions of particle bunches per second – orders of magnitude more than required to meet the luminosity demands of, for example, future linear colliders [3].

In order to reach this upper limit with a practical accelerator, however, robust developments in plasma source technology will be required. This will likely necessitate operating plasma accelerators with bunch patterns similar to those regularly deployed at FLASH, i.e. macropulses of long trains of bunches accelerated with MHz frequencies, in order to manage the high average power. Answering the questions of how to best overcome this challenge will form the basis of future experimentation at FLASHForward.

Contact: Richard D'Arcy, richard.darcy@desy.de  
Jens Osterhoff, jens.osterhoff@desy.de

## References:

- [1] A. Ferran Pousa *et al.*, Proc. IPAC'17, TUPIK007 (2017)
- [2] R. D'Arcy *et al.*, Nature 603, 58–62 (2022)
- [3] M. Aicheler *et al.*, CERN-2012-007 (2012), doi: 10.2172/1120127



# Machine learning at LUX

Leveraging intelligent algorithms to understand and improve plasma accelerators

Laser plasma accelerators are on the verge of driving real-world science applications. Machine learning techniques could prove decisive to exploit their full potential. The LUX laser plasma accelerator at DESY recently demonstrated autonomous tuning of the beam quality using intelligent optimisation algorithms and surrogate modelling. Analysing the experimental data with neural networks provided important insights into the root causes for remaining parameter variations in the system. The results fuel the development of KALDERA, the next-generation high-repetition-rate laser plasma accelerator at DESY.

## Compact accelerators

Thanks to their extreme accelerating gradients, laser plasma accelerators promise to add very compact facilities to the portfolio of accelerator technology. These potentially small and inexpensive setups would greatly increase the availability of particle accelerators and thus open up possibilities for novel applications. To mature plasma accelerators for applications, however, significant improvements in the quality, stability and reproducibility of the accelerated electron beams are still required. These key challenges are a consequence of the complex acceleration process, where an extremely intense laser drives a microscopic wave in a plasma, which then acts as the accelerating structure. This process takes place on tiny length and time scales – of micrometres and femtoseconds – and makes it very difficult to observe and, more importantly, to control and improve the acceleration.

At the LUX laser plasma accelerator at DESY (Fig. 1), which is developed and operated in close collaboration with Universität Hamburg, machine learning methods were recently leveraged to tune the output beam quality and make important progress in understanding and eventually reducing the causes of instabilities of the beam [1, 2].

## Autonomous beam quality optimisation

A particular challenge on the way to using laser plasma accelerators as drivers for real-world applications is to reduce the energy spread of the generated electron beams. Specifically for this purpose, the LUX team developed a novel plasma source that enables targeted control of the injection and acceleration dynamics [1]. In this plasma source, a high-quality electron bunch is first injected into the plasma wave and then accelerated to higher energies.

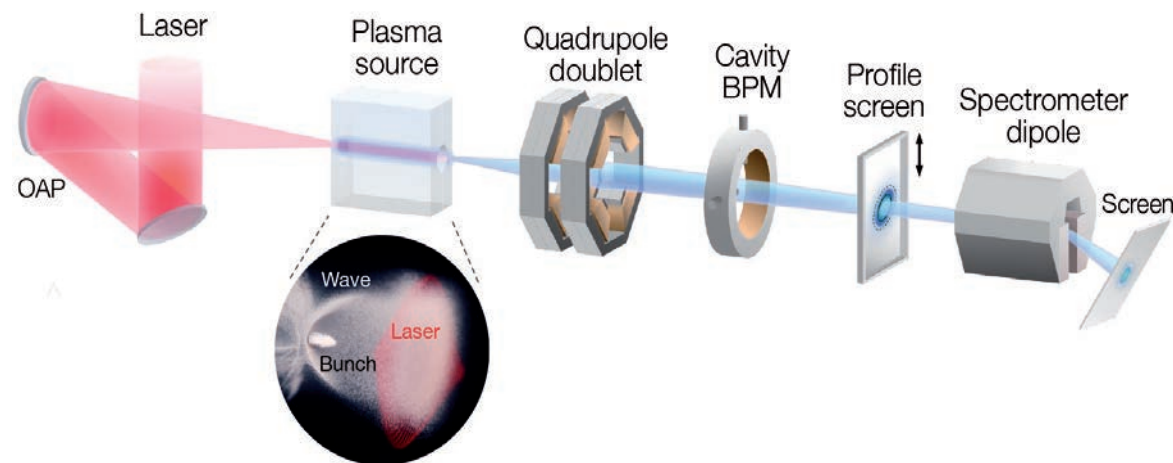

**Figure 1**  
Schematic of the LUX accelerator: The 100 TW ANGUS laser is focused into a plasma source where it ionises hydrogen gas and drives a plasma wave (circular inset). An electron bunch is injected into the wave in a first nitrogen-doped section of the plasma source and then accelerated to hundreds of MeV in pure hydrogen over the following few millimetres. To analyse the beam parameters, the accelerated electron bunch is captured by quadrupole magnets and transported to several diagnostic devices. Figure adapted from [1] and Science Communication Lab.

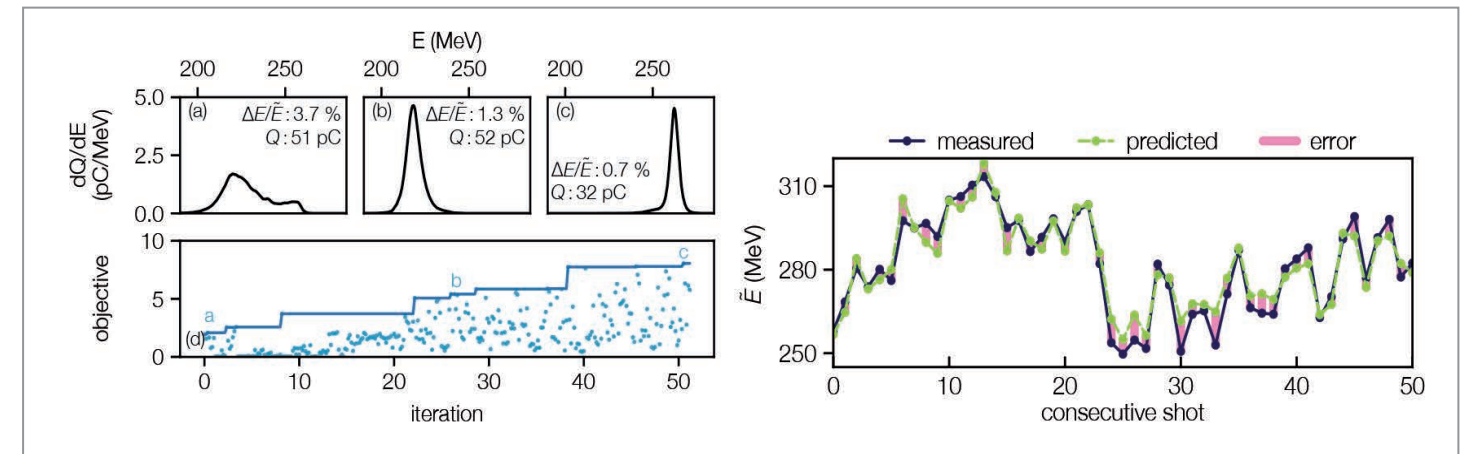

**Figure 2**  
Application of machine learning at LUX: The left plot shows the evolution of the beam quality during the Bayesian optimisation procedure. As the algorithm does its work of maximising the objective, the spectra of the generated electrons (upper plot) become more and more narrow, resulting in a reduction of the energy spread. The right plot demonstrates the predictive capabilities of the neural network surrogate model. Using only the laser parameters as inputs, the model accurately predicts (green) the real measurements (blue) of the median electron energy. Figure adapted from [1] and [2].

While absorbing energy from the plasma wave, the bunch deforms the accelerating field through a process known as beam loading. Under optimal conditions, this mechanism can be used to flatten the accelerating fields, which will preserve the initially small sub-percent-level slice energy spread.

However, the entire non-linear process is sensitive to many tuning parameters, such as the energy of the laser, the laser focus position, or the density and shape of the plasma. Given the complexity of the system, it is typically not possible to predict the exact configuration of parameters that will result in the best beam quality, and the sheer number of possible configurations makes testing and scanning a tedious task.

Recent results at LUX [2] prove that machine learning algorithms can master this complicated problem very well. For this, a method known as Bayesian optimisation uses online measurements of the machine parameters and the resulting electron beam to build a model that describes the relation between the tuning parameters and the electron beam quality. This model can be used as a map to find a configuration that potentially gives better beam quality. The algorithm iteratively tunes the accelerator, takes new measurements and improves the model to eventually find the optimal configuration of the accelerator. At LUX, with the help of Bayesian optimisation, it was possible to reduce the energy spread of the electron beam to less than 1% (Fig. 2), which is a critical prerequisite for demanding applications such as a free-electron laser.

## Predictive modelling for improved beam stability

Although it is now possible to find a configuration that – on average – produces high-quality electron beams, the beam parameters still deviate slightly from this optimum on a shot-to-shot basis. These variations are caused mainly by

fluctuations in the drive laser system, such as small jitters in the energy or focus position of the laser pulse. Due to the low repetition rate (1 Hz) at LUX, it is difficult to stabilise these variations, which are caused, for example, by air fluctuations or acoustic vibrations at much higher frequency. However, over the next few years, DESY will develop a next-generation drive laser for plasma applications, called KALDERA, which will operate at up to kHz repetition rates. It is thus extremely important to understand, differentiate and quantify the effects of jitters in different laser parameters on the electron beam already today in order to find the major sources of instability and to specifically guide the design of future facilities.

A neural network that was trained on thousands of measurements at LUX has learned the interplay between tens of laser parameters and the electron beam quality. The network acts as a surrogate model of the accelerator and can accurately predict the parameters of the electron beam when given the properties of the drive laser for each individual shot [1]. With this knowledge, it is now possible to quantify the effect of each of the laser parameters and define design constraints for the stability of KALDERA. Predictive models like this, in combination with the kHz repetition rate provided by KALDERA, form the foundation for active stabilisation and feedback control as an essential ingredient to drive real-world applications with plasma accelerators.

Contact: Manuel Kirchen, [manuel.kirchen@desy.de](mailto:manuel.kirchen@desy.de)  
Sören Jalas, [soeren.jalas@desy.de](mailto:soeren.jalas@desy.de)  
Andreas Maier, [andreas.maier@desy.de](mailto:andreas.maier@desy.de)

## References:

- [1] M. Kirchen *et al.*, *Phys. Rev. Lett.* **126**, 174801 (2021)
- [2] S. Jalas *et al.*, *Phys. Rev. Lett.* **126**, 104801 (2021)



# KALDERA laser lab

New home for KALDERA laser development activities

With the support of 16 technical and infrastructure groups, DESY is currently building a new laser lab for the development of the future KALDERA laser, i.e. the Kilowatt Average Power Laser at DESY for Revolutionary Accelerators. The new laboratory, which will be completed by mid-2022, features 400 m<sup>2</sup> of class ISO5 and ISO6 cleanroom space to provide optimum conditions for the demanding development of a high-repetition-rate laser plasma acceleration drive laser. The laser lab is part of the ATHENA complex in the former DORIS hall and located right next to the accelerator tunnel where the future plasma accelerator experiment will be located.

## Making headway

Throughout 2021, the DORIS hall (Building 30) has seen massive transformation (Fig. 1 and 2). The location of the former OLYMPUS detector is now the basement of the new laboratory, housing racks for the electronics and controls of the future KALDERA laser. The ceiling of this rack room forms the new lab floor. It is a single concrete slab, which was specifically designed to decouple the laser lab from outside vibrations. The team measured the

vibration frequency spectrum of the DORIS hall and then engineered the eigenfrequency of the concrete slab to match a quiet range of this spectrum.

Today, the new floor already holds the cleanroom – a steel frame with sandwich walls. A total of 130 filter fan units in the plenum create a laminar flow in the lab space underneath. Air from the cleanroom is drawn through grid insets into the sandwich-type outer lab walls and then recircu-



Figure 2

Left: Construction of the basement (rack room). Right: After pouring the new concrete baseplate. The steel frame for the cleanroom has already been installed.

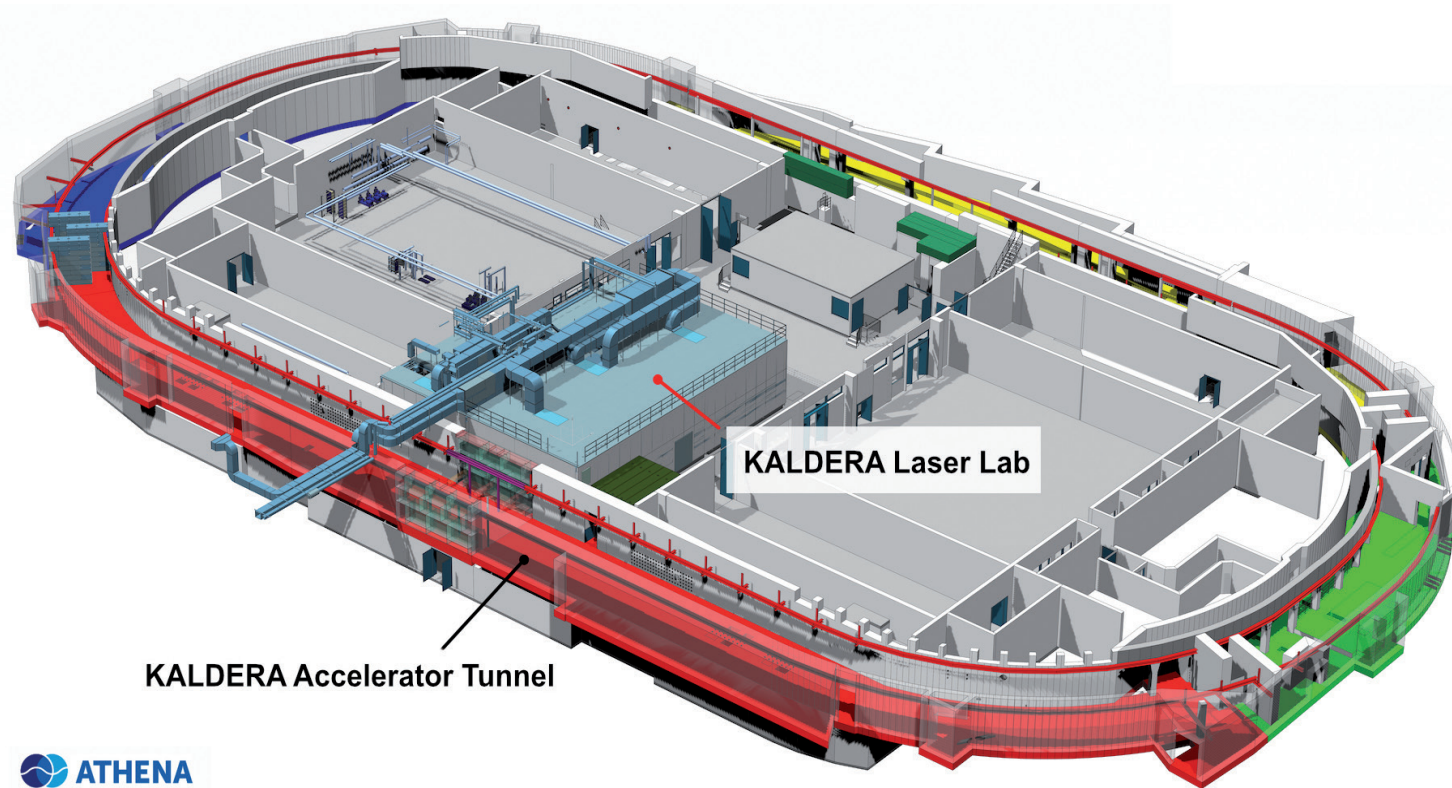

Figure 1

The KALDERA laser lab (light blue) is located next to the accelerator tunnel (red) that will host future laser plasma accelerator activities.

lated to the plenum. The air conditioning is located on the roof of the lab and mechanically isolated from the floor.

Building on the experience with other laser labs on campus, the temperature and humidity within the lab will be stabilised to  $21^{\circ}\text{C} \pm 0.1^{\circ}\text{C}$  and  $45\% \pm 5\%$  relative humidity. Most of the power supplies and other electronics are removed from the lab and located in the rack room directly underneath, removing further vibrational stimuli and heat sources.

## Laser development

The KALDERA laser development was launched in early 2020 on initiative of Wim Leemans, DESY Director of the Accelerator Division. The basic challenge for KALDERA is to increase the repetition rate of the drive laser to the kHz level in order to enable laser-plasma-accelerated electron beams at competitive average power. Practically, this means developing a laser of kW-level average power, which is unexplored laser performance territory for the required pulse parameters (TW peak power at fs pulse duration). On the path to this challenging goal, the team will have to improve and highly customise almost all laser components commonly used in such systems. At the same time, the integration of the laser in a state-of-the-art control and machine protection system is challenging. Handling the constant stream of data at kHz-level repetition rates, pre-processing data on device and optimising performance using modern machine learning techniques are timely topics that are shared with other forefront projects on campus.

To kick off the laser development, a new front-end was built in 2021. This front-end, called MALCOLM, is in its final stage of commissioning. It will be the first laser to be transferred to the new lab right away, and it will serve as the backbone for all future developments. First characterisation of the laser performance shows a very high pulse quality

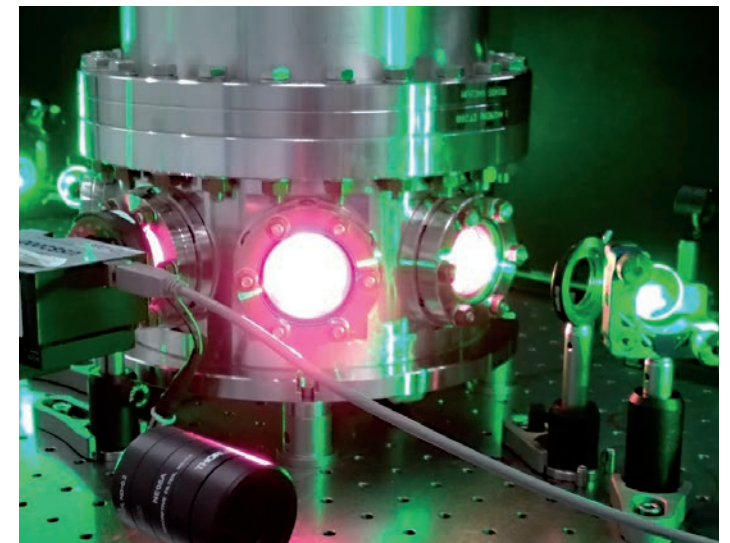

Figure 3

Test stand for the characterisation of Ti:Sa laser crystals, carried out in close collaboration of the Lasers for Plasma Acceleration group at DESY and the Ultrafast Optics and X-rays group at CFEL

[1]. In parallel, the team started characterising the properties of selected Ti:Sa crystals that will be used in the future KALDERA laser. Procurement of some key components has started, and the team is establishing new collaborations to overcome current technology limitations.

Contact: *Andreas Walker*, [andreas.walker@desy.de](mailto:andreas.walker@desy.de)  
*Guido Palmer*, [guido.palmer@desy.de](mailto:guido.palmer@desy.de)  
*Andreas Maier*, [andreas.maier@desy.de](mailto:andreas.maier@desy.de)

## Reference:

[1] T. Eichner *et al.*, *Opt. Express* 30, 3404 (2022)



# Thomson scattering diagnostics

Measuring laser plasma electron bunches *in situ*

Laser plasma acceleration is a promising technique to shrink accelerators from the tens or hundreds of metres required for radio frequency (RF) facilities to centimetre scales. However, while reaching similar energies compared to state-of-the-art RF accelerators, laser plasma accelerators (LPAs) have not yet achieved the same level of stability or energy spread. Detailed understanding of the acceleration process is crucial for further improvement. As measurements of the acceleration process are very difficult, it has thus far mainly been studied theoretically using simulations. The Plasma Accelerators group has developed a new technique to measure the energy of an electron bunch during acceleration within the plasma at DESY's FLASHForward facility, which can help to further understand and improve the quality of LPAs in order to reduce the footprint of future facilities.

## Laser plasma acceleration in a nutshell

In an LPA, a high-intensity laser is shot into a plasma source to accelerate electrons to relativistic energies over small distances [1]. In the process, the gas in the plasma source is ionised by the laser to create a plasma, which means that the gas is split up into electrons and ions. Afterwards, the ponderomotive force of the laser pushes away the electrons from its path. The ions take longer to respond to the force as they are thousands of times heavier than the electrons and remain effectively static

over the time scale of the interaction. From this separation of electrons and ions, a wakefield is created (Fig. 1). In these wakefields, high electric fields of more than 100 GV/m are sustained, meaning that electrons can be accelerated to energies of 100 MeV over a distance of 1 mm.

## Thomson scattering as a non-invasive diagnostic technique

Diagnostics are crucial for all accelerators – in industrial

or medical applications as well as in research – in order to control the operation (e.g. the dose delivered to a patient) and to understand the processes involved. For plasma accelerators, many different diagnostic methods have been developed [3]. However, due to problems arising from the micrometre scales of the accelerator (as seen in Fig. 1), from electromagnetic pulses and from the high-intensity laser driver, these techniques can only measure properties of the electrons after the acceleration.

Thomson scattering (TS) can be used to overcome these issues and can therefore function as an *in situ* diagnostic method for the electron bunch. TS can be described as scattering of electrons and photons, where the photons gain energy from the electrons. For head-on scattering between an electron and a photon, the energy of the photon after the scattering scales as  $4 \cdot \gamma_e^2$ , where  $\gamma_e$  is the relativistic Lorentz factor of the electron – a measure of its energy. This dependence between electron energy and resulting photon energy therefore suggests the use of TS as a diagnostic method. After the interaction, the photons have an energy in the X-ray regime and can thus leave the plasma accelerator without further interaction, while containing information about the electron energy at the position of the interaction.

## First *in situ* measurement of electron beam energy

The experimental realisation of this technique is very challenging. The length scales in plasma accelerators are just a few micrometres, and consequently the entire setup must be aligned and timed to micrometre and femtosecond precision, respectively. At the same time, the setup needs to be adjustable without losing the precise alignment in order to measure the electron beam energy at different positions.

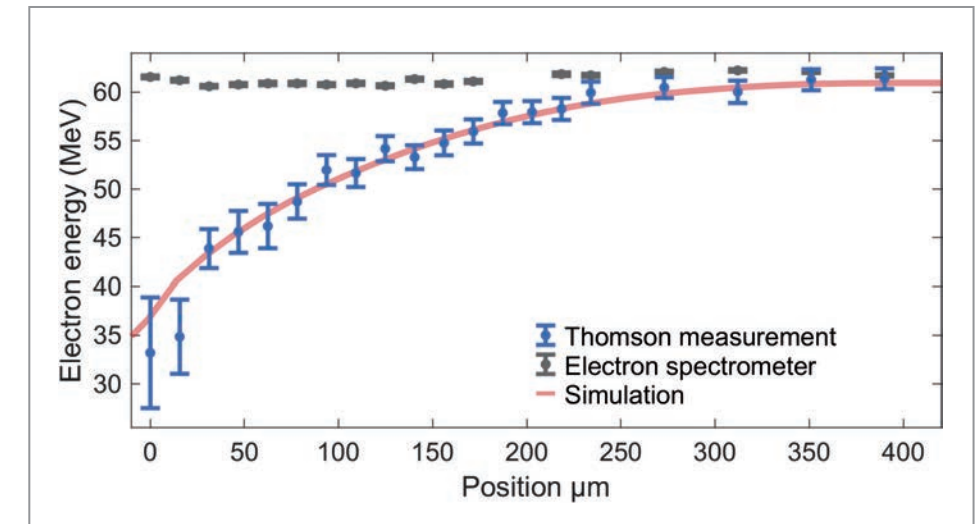

Figure 2  
First *in situ* measurements of the electron energy evolution inside an LPA. The results are in good agreement with simulations of the process.

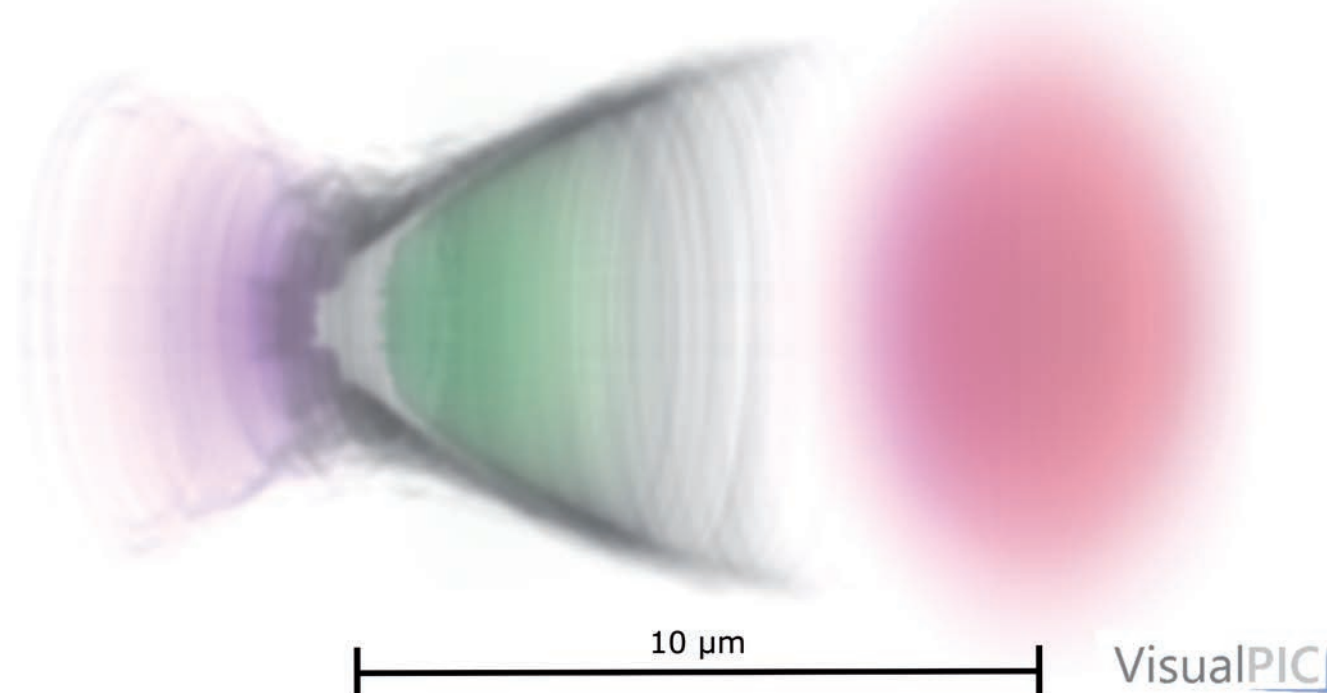

Figure 1  
Schematic of laser plasma acceleration [2]. The laser (red) pushes away electrons (grey) so that a wakefield (green/purple) is created.

In experiments conducted using a 25 TW laser system at the FLASHForward facility [4], the electron bunch energy was measured using TS during acceleration of the bunch. In addition, a dipole electron spectrometer was used to monitor the final electron beam energy. The results are shown in Fig. 2 together with simulations of the acceleration process. The agreement of the TS measurements with simulations confirms the possibility of accurately measuring the electron properties within the wakefield using TS. The constant level of the final electron energy measured using the spectrometer highlights the non-invasive nature of this diagnostic method, showing that the measurement does not alter the electron bunch. This technique can therefore also be used when the electron bunch is produced for a certain application and needs to be monitored.

In the future, TS could enable the improvement of LPAs by precise tuning based on measurements of the electron evolution within the plasma. These studies could thus facilitate the use of LPAs in a wide range of scientific, medical and industrial applications, where the compactness of LPAs and their unique beam properties can lead to many exciting developments.

Contact: Simon Bohlen, [simon.bohlen@desy.de](mailto:simon.bohlen@desy.de)  
Kristjan Pöder, [kristjan.poder@desy.de](mailto:kristjan.poder@desy.de)  
Jens Osterhoff, [jens.osterhoff@desy.de](mailto:jens.osterhoff@desy.de)

## References:

- [1] T. Tajima, J. M. Dawson, Phys. Rev. Lett. 43, 267 (1979)
- [2] A. Ferran Pousa *et al.*, Proc. IPAC'17, TUPIK007 (2017)
- [3] M. C. Downer *et al.*, Rev. Mod. Phys. 90, 035002 (2018)
- [4] S. Bohlen *et al.*, "In situ measurement of electron energy evolution in a laser-plasma accelerator", submitted to Phys. Rev. Lett.



# Plasma injector prototype

Bridging the gap between plasma accelerators and synchrotron light sources

The present state of progress in laser plasma wakefield acceleration gives reason to consider it as a practical alternative to conventional particle accelerators. A promising application would be to use a laser plasma accelerator as an injector for a synchrotron light source. Yet, the energy spread and jitter of the laser plasma beam pose a significant difficulty for efficient injection. As a proof-of-concept study conducted at DESY shows, the energy spread and jitter of the electron beam can be reduced down to the sub-permille level using presently available conventional accelerator technology, such as magnetic chicanes and X-band radio frequency (RF) cavities. A prototype injector could demonstrate the required beam energy bandwidth and stability to enable efficient injection into state-of-the-art storage rings.

## Active energy compression for low energy spread and jitter

Laser plasma accelerators (LPAs) have been attracting attention in the community for years, promising unmatched accelerating gradients and compact, energy-efficient acceleration. In a synchrotron light source, an LPA injector could be used to top up the storage ring, significantly reducing the spatial footprint and energetic cost of the accelerator complex. To achieve this, the LPA injector must deliver sufficient charge within the small energy acceptance of the ring to compensate for beam charge losses. For example, DESY's future flagship synchrotron light source PETRA IV could make use of 50–100 pC bunches with 10  $\mu\text{m}$  rad or smaller normalised emittance and an RMS energy spread and jitter well below 1%. Achieving the latter poses a particular challenge.

A promising technique to reduce the energy variation is an active energy compression scheme [1]. It requires a simple magnetic chicane to stretch the bunch and create a linear correlation between the particles' energies and their longitudinal positions (chirp) as well as an active dechirper (e.g. a short laser-driven plasma stage or an RF cavity) to apply a linear energy kick and put the particles precisely on the

design energy. A crucial advantage of this method is that it reduces both the energy spread and the deviation of the central beam energy. For applications in synchrotron light sources, which do not require the ultrashort bunch lengths and high peak currents (1–10 kA) available from LPA beams, it is favourable to consider an RF dechirper, acting together with a large decompression chicane. This article briefly describes a proof-of-concept low-energy 500 MeV LPA injector with an energy compressor based on X-band RF technology; more details are available in Ref. [2].

## Injector design

The prototype injector (Fig. 1a) consists of an LPA and a beamline composed of conventional accelerator components that captures the LPA beam, corrects the chromatic emittance increase and reduces the energy variation. The configuration of the LPA is conceptually identical to that of the LUX experiment [3], where a specially tailored gas capillary target is used to control the injection and acceleration in the optimal beam-loading regime in order to achieve electron beams with 1%-level energy spreads. The LPA is followed by a quadrupole triplet that captures the beam and matches it to a chicane, made up of dipoles

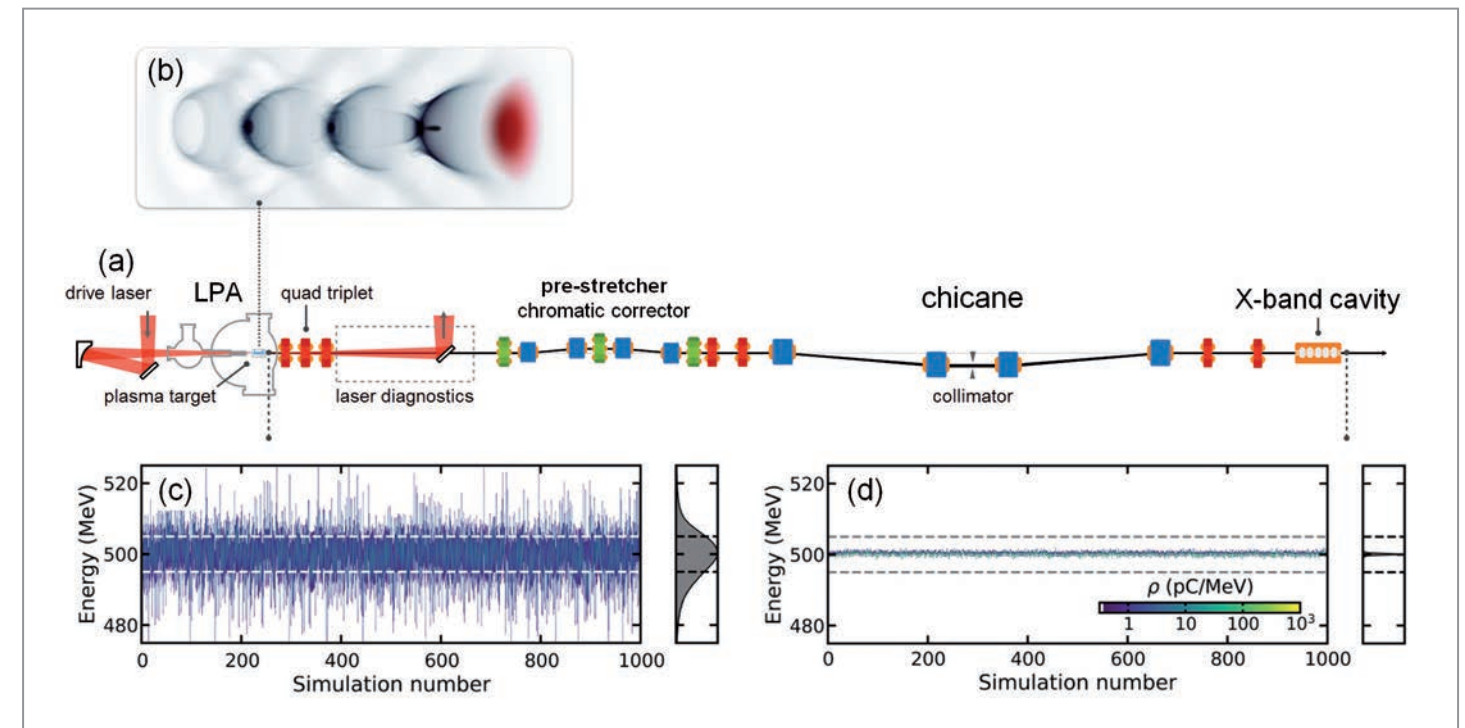

Figure 1

(a) Schematic layout of the plasma injector prototype beamline. (b) Particle-in-cell simulation of the laser plasma accelerator stage. (c) and (d) Electron beam spectra before and after energy compression, respectively.

and sextupoles, which reduces the chromatic emittance growth and slightly stretches the bunch. The beamline continues with another chicane to induce a large longitudinal decompression and a linear energy–time correlation over the beam. This energy correlation is then cancelled by a short X-band RF cavity.

## Expected beam quality

To confirm the beamline performance, a series of macro-particle simulations was conducted with the Ocelot tracking code, using a realistic LPA beam from a simulation performed with the FBPIC particle-in-cell code (Fig. 1b). In optimal conditions, the simulations yield bunches of about 80 pC with a very low final projected energy spread of just 0.005% and a normalised emittance of 2  $\mu\text{m}$  rad. In a real-world scenario, the mean energy and chirp of the LPA beam will vary, as shown in Fig. 1c, for example, due to variations of the bunch charge resulting in different levels of beam loading. Presently, a central energy stability of 1% RMS can be expected in state-of-the-art setups. On top of that, one can realistically assume a 100 fs RMS timing jitter between the LPA drive laser and the RF. Taking into account both the energy and the timing jitter, the simu-

lations predict a final beam energy variation of 0.04%, effectively compressing the initial energy output by a factor of 35 (Fig. 1d).

These results suggest that this low-energy plasma injector prototype can provide high-quality electron beams compatible with the injection requirements of future synchrotron light sources. The presented design is scalable to higher energies, in particular to 6 GeV, which would allow a top-up operation of PETRA IV.

Contact: Sergey Antipov, [sergey.antipov@desy.de](mailto:sergey.antipov@desy.de)  
Ángel Ferran Pousa, [angel.ferran.pousa@desy.de](mailto:angel.ferran.pousa@desy.de)  
Alberto Martínez de la Ossa, [alberto.martinez.de.la.ossa@desy.de](mailto:alberto.martinez.de.la.ossa@desy.de)  
Jens Osterhoff, [jens.osterhoff@desy.de](mailto:jens.osterhoff@desy.de)

## References:

- [1] A. Ferran Pousa *et al.*, arXiv:2106.04177 (2021)
- [2] S. Antipov *et al.*, Phys. Rev. Accel. Beams 24, 111301 (2021)
- [3] M. Kirchen *et al.*, Phys. Rev. Lett. 126, 174801 (2021)



# HiPACE++

Plasma acceleration simulations become 10 times faster and 1000 times more efficient

Plasma accelerators have demonstrated compelling progress year after year, but simulations of such systems remain notoriously difficult and expensive. Combining efficient numerical methods and the latest high-performance computing (HPC) practices with the use of graphics processing units (GPUs), the HiPACE++ simulation code demonstrates a speed-up by orders of magnitude compared to competitors. HiPACE++, which was launched at DESY in mid-2021, is now an open-source GPU-capable code available for the community for challenging 3D simulations of plasma acceleration in the quasi-static regime.

## Simulating plasma acceleration with the particle-in-cell method

Plasma accelerators harness the multi-GeV/m fields routinely produced in plasmas to accelerate charged particles over short distances. Given further progress on beam quality and stability, they could help generalise the use of particle accelerators by making them much more compact and less costly. Since the emergence of plasma acceleration (Fig. 1), the community has strongly relied on numerical simulations to explore new ideas [1], propose

new concepts and interpret hard-to-diagnose experiments. Such simulations are very challenging as the plasma operates in a non-linear kinetic regime rather than a fluid regime, requiring in principle the mapping of a 6D position-momentum phase space.

The particle-in-cell (PIC) method [3] is the method of choice for simulating such systems today. By mapping the fields on a 3D grid and capturing the plasma response with macroparticles (Fig. 2), the PIC method enables simulations

of kinetic plasma dynamics at reasonable computing costs, in an algorithm well suited for GPU computing. Several variants of the PIC method have been developed. With the HiPACE code [4], DESY has been a leader in the quasi-static PIC method, a reduced model showing excellent accuracy and performance, although only implemented for central processing units (CPUs) so far.

## Porting a quasi-static PIC code to GPU

In the past few years, the HPC landscape has been shifting towards more complex architecture, in particular accel-

erated computing, where CPUs on compute nodes only serve as drivers to orchestrate much more powerful processing units (called accelerators). In fact, seven out of the ten fastest supercomputers in the world rely on GPU accelerators today (see [www.top500.org](http://www.top500.org)). The standard PIC method was ported to GPU recently, demonstrating a large speed-up, but the quasi-static PIC method had not yet been transferred.

Exploiting the particularities of the quasi-static PIC method, HiPACE++ is the first 3D quasi-static PIC code running entirely on GPU, written in C++. In particular, in this method, a 3D problem is computed as  $N$  2D problems (where  $N$  is the longitudinal number of cells, on the order of 1000). The algorithm was rewritten so the 2D problems are solved on a single GPU rather than many CPU cores, drastically reducing communications and fully harnessing the power of GPUs (Fig. 3). After further adjustments of the parallelisation strategy, enabling simulations on many GPUs, HiPACE++ has all the capabilities of a modern quasi-static PIC code at better performance: Running HiPACE++ on a few GPUs is 10 times faster and costs 1000 times less node hours than running a similar simulation on thousands of CPU cores. Such a gain in performance enables new simulation regimes, unprecedented high resolution and large machine-learning-based optimisation campaigns to improve the performance of plasma accelerators.

Contact: Maxence Thévenet, [maxence.thevenet@desy.de](mailto:maxence.thevenet@desy.de)  
Jens Osterhoff, [jens.osterhoff@desy.de](mailto:jens.osterhoff@desy.de)

## References:

- [1] T. Tajima, J. M. Dawson, *Phys. Rev. Lett.* **43**, 267 (1979)
- [2] <https://github.com/AngelFP/VisualPIC>
- [3] C. K. Birdsall, A. B. Langdon, *Plasma physics via computer simulation*, CRC press (2018)
- [4] S. Diederichs et al., *arXiv:2109.10277* (2021)

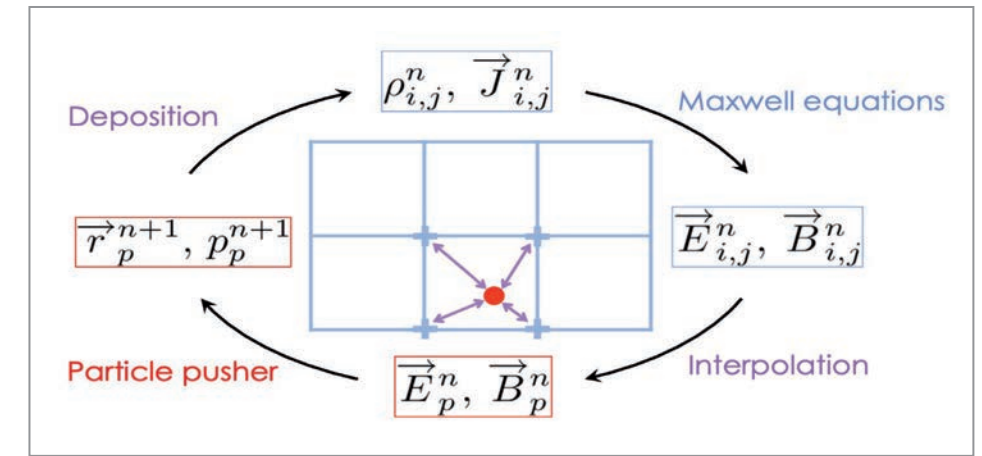
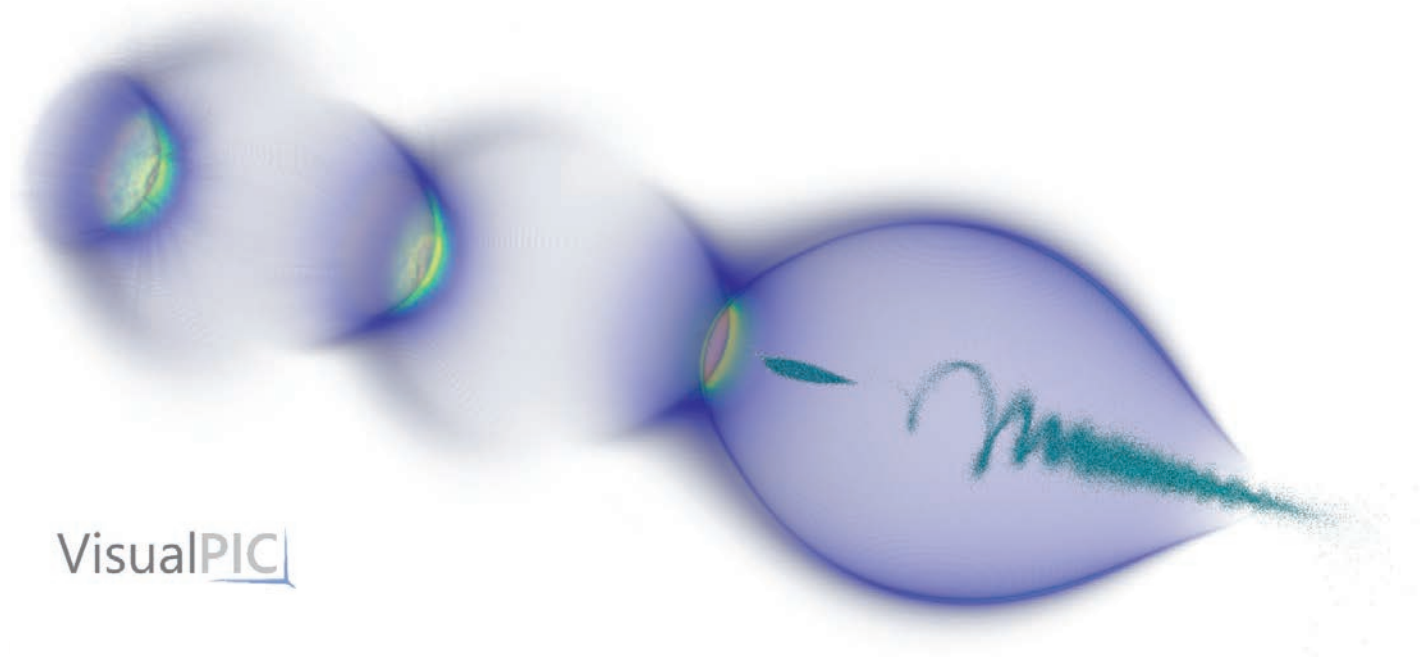

Figure 2

A PIC simulation contains a mesh (blue) where the electric and magnetic fields are defined (6 cells in the figure,  $1000^3$  in production) and macroparticles (red) representing a collection of physical particles (1 macroparticle in the figure,  $1000^3$  in production). At each time step, macroparticles and fields are advanced, and interpolations are made between them.



Rendering of a 3D HiPACE++ simulation of the hosing instability. An intense beam of electrons, the driver (cyan corkscrew shape on the right), propagates from left to right at nearly the speed of light in a plasma and expels the plasma electrons from its path. The electron density (dark blue) is perturbed and a "bubble" with no plasma electrons forms behind the driver (in its wake), where the remaining ions create strong accelerating and focusing fields. Another beam of electrons, the witness (cyan elongated shape on the left of the driver) located in the bubble can be accelerated by these strong fields. Asymmetric effects like the hosing instability (which causes the driver to have a corkscrew shape) can have a deleterious effect on the quality of the witness beam; understanding them requires the use of 3D particle-in-cell codes. The rendering was done with VisualPIC [2].

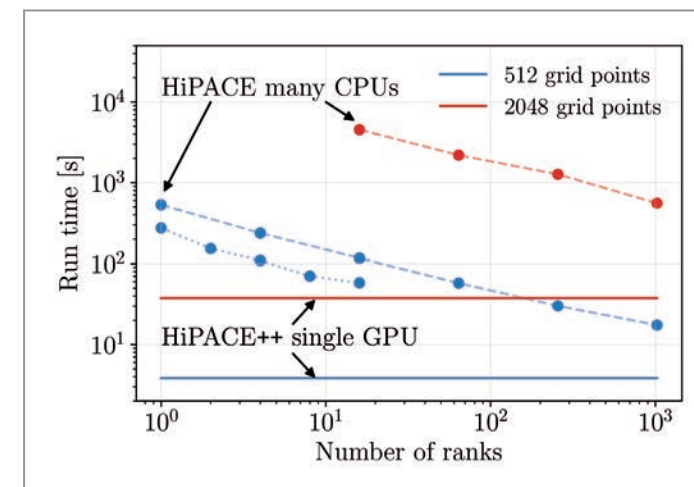

Figure 3

Performance comparison between a single GPU and many CPUs for a small problem (512 x 512 x 1024 cells, blue lines) and a large problem (2048 x 2048 x 1024 cells, red lines) on the JUWELS Booster, the fastest European supercomputer, at the Jülich Supercomputing Center. For the small problem, HiPACE++ is 10 times faster on 1 GPU than HiPACE on 1024 CPU cores. For the large problem, HiPACE++ is 20 times faster. Furthermore, the simulation cost (number of compute nodes multiplied by the simulation time) is 1000 times lower on GPU than on CPU.



# The SINBAD-ARES linear accelerator

Accelerator R&D experiments and new challenges on the horizon

In 2021, the linear accelerator of the Accelerator Research Experiment at SINBAD (ARES) received a major upgrade. The aim of ARES is to accelerate ultrashort (sub-/single-femtosecond) electron bunches with an energy of up to 155 MeV and an arrival time jitter below 10 fs (RMS). To produce these bunches and diagnose them, a magnetic bunch compressor and two X-band transverse deflecting cavities were installed. The ARES linear accelerator is regularly used by internal and external groups to test and develop new accelerator components, e.g. for novel acceleration techniques, machine learning studies and beam instrumentation development in ultrafast science. ARES will also be modified for medical applications in cancer treatment in a collaboration with the Medical Center Hamburg-Eppendorf (UKE).

## ARES upgrade shutdown and beam commissioning

Between March and July 2021, ARES underwent a long shutdown to install a movable magnetic bunch compressor (Fig. 1), two X-band transverse deflecting structures (TDS, Fig. 2), 17 additional magnets, additional beam instrumentation (e.g. beam position monitors, intensity monitors and collimators) and the corresponding infrastructure (water

cooling, power, cabling), effectively doubling the length of the facility. The second half of the year was dedicated to the commissioning of the new beamline devices. Unfortunately, the modulators and klystrons for the X-band systems are still delayed due to pandemic-related delivery problems. The installation of these devices and the commissioning of the X-band TDSs will start in 2022.

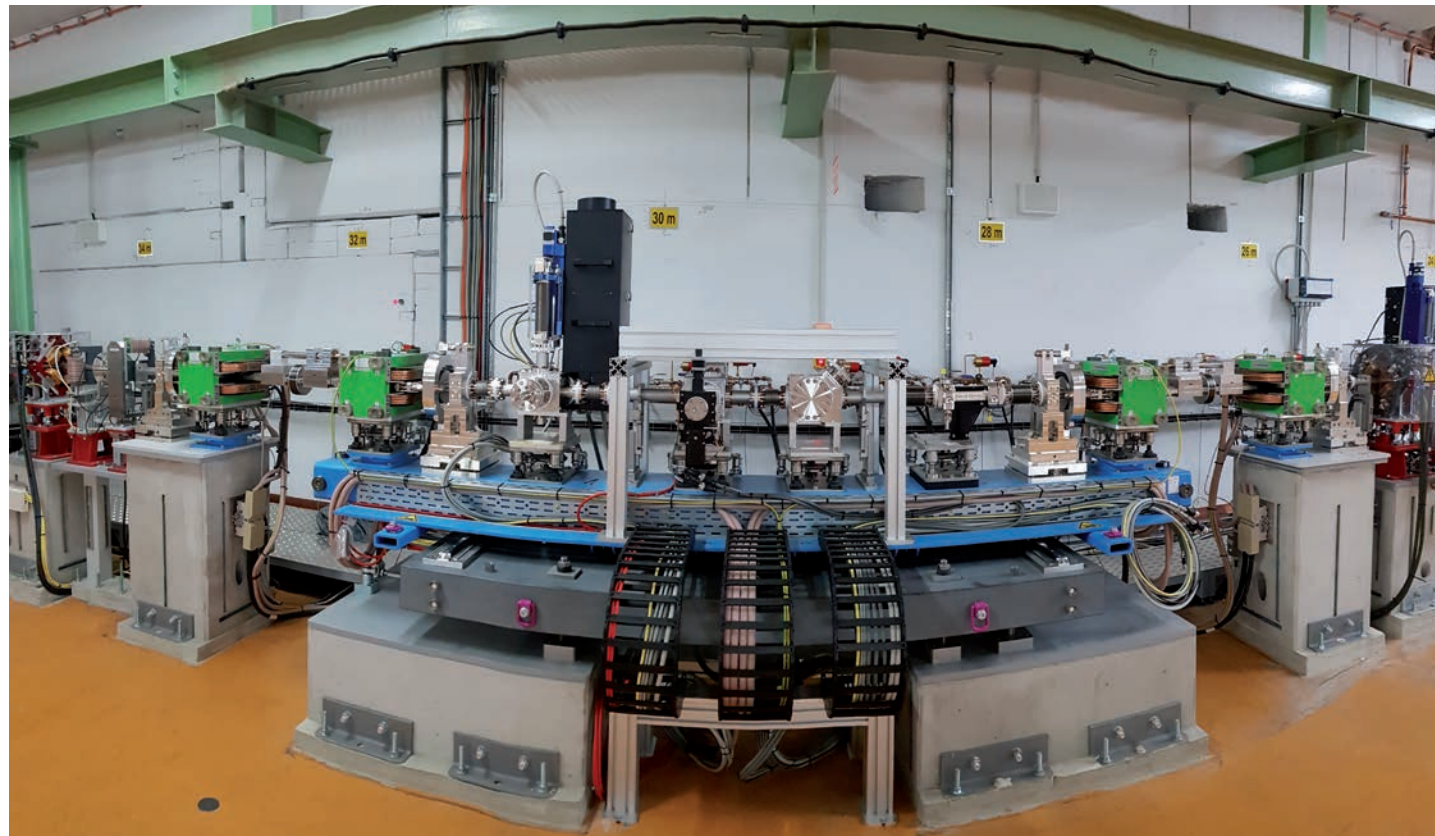

Figure 1  
Fish-eye view of the movable magnetic bunch compressor with four dipole magnets (green) and beam instrumentation, beam position monitor, collimators and screen station (from right to left)

The beam parameters of ARES after the upgrade looked very promising, with a minimal measured bunch length of 35 fs, which is the resolution limit of the currently installed beam instrumentation. During several long-term measurements, ARES showed world-record energy stability and reproducibility, which have already been praised by several user groups.

## Accelerator R&D at ARES

In 2021, ARES was used for various internal and external accelerator R&D projects, e.g. beam position monitor (BPM) development and tests of miniaturised beam screens. The DESY Beam Controls (MSK) group regularly uses ARES to perform studies on the Helmholtz project Autonomous Accelerator (see p. 76). The Accelerator on a CHip International Program (ACHIP) collaboration had three beamtimes at ARES to study novel acceleration techniques with dielectric structures. A major achievement was the transmission of the ARES electron beam through the 1  $\mu\text{m}$  aperture of such a dielectric structure (Fig. 3). The next milestone, which should be reached in a beamtime scheduled for February 2022, will be to achieve temporal overlap between the experiment's laser and the ARES electron beam.

## Outlook and new challenges

The main milestones for ARES in 2022 will be the completion of the X-band TDS installation and the next steps towards the generation and characterisation of ultrashort electron bunches. In terms of R&D projects, ARES will be used by several DESY groups, e.g. for waveguide window and extraction kicker magnet tests, BPM commissioning, photocathode laser development, autonomous-accelerator studies, novel master oscillator development and femto-second synchronisation. The ACHIP experiments will continue, and a micro wirescanner from PSI in Villigen, Switzerland, will also be tested. In early 2022, an additional

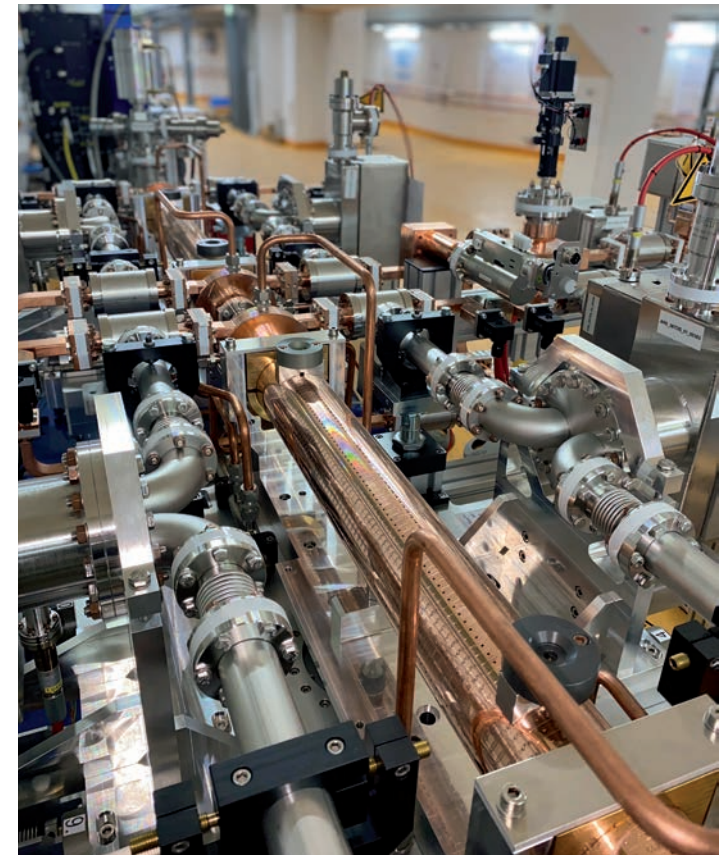

Figure 2  
Detail of the X-band TDS system, showing the two copper deflecting structures. The waveguide system is visible on the top right.

experimental chamber will be installed at ARES to test detectors in collaboration with the DESY Particle Physics division. ARES will also be fitted with a beam exit window to allow medical application studies for cancer treatment in a collaboration with UKE, with first tests to be performed in mid-2022.

Contact: Florian Burkart, [florian.burkart@desy.de](mailto:florian.burkart@desy.de)

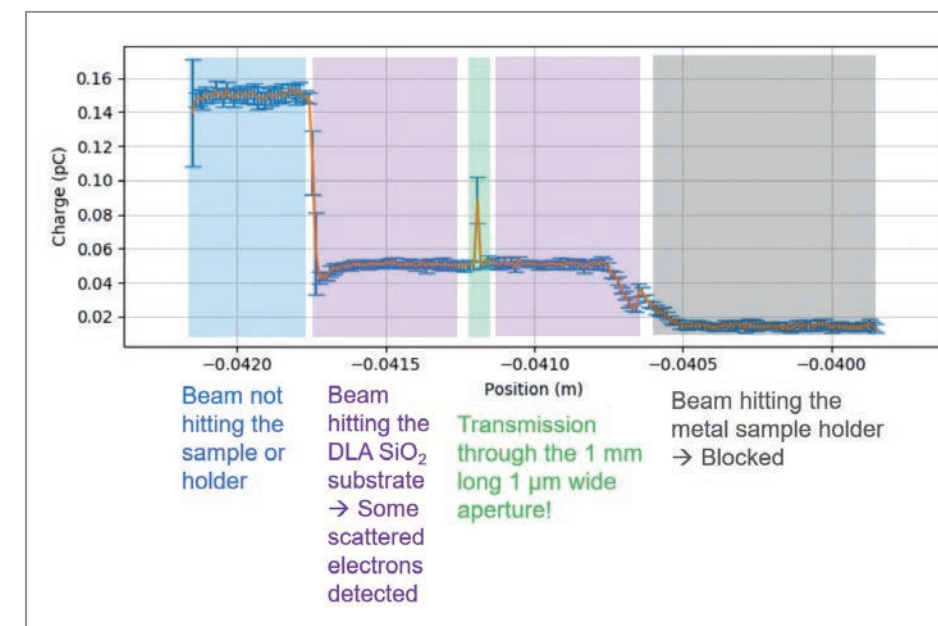

Figure 3  
Charge measurement showing the transmission of the ARES electron beam through the 1  $\mu\text{m}$  aperture of the ACHIP sample. The charge is measured by an intensity monitor downstream of the structure. When the beam is transmitted through the aperture (green area), the monitor measures the transmitted charge. In the purple area, electrons hit the sample and get scattered. In the grey area, the electrons are stopped by the sample holder.



# Autonomous accelerators

Applying reinforcement learning to accelerator operation

Modern accelerator facilities are growing in complexity, with increasing demands on availability, reliability, flexibility and the number of operation modes. Pushing the performance of modern facilities to the limit results in further demands for advanced control methods in multidimensional parameter spaces – faster than any human operator can provide. Machine learning (ML) has emerged as an essential component in orchestrating the simultaneous operation of multiple subsystems and has also gained interest for accelerator control, mostly focusing on tuning optimisation. Although replacing an expert operator with an autonomous agent is still far from being achievable, the Autonomous Accelerator project aims to take the first steps in this direction by bringing reinforcement learning (RL) to accelerator operation.

## The Autonomous Accelerator project

The Autonomous Accelerator project is a collaboration between KIT in Karlsruhe and DESY, financed by the Helmholtz Artificial Intelligence (AI) Cooperation Unit with funding from the Association's Initiative and Networking Fund [1], which aims to apply RL to accelerator operation. RL is a machine learning approach where a software agent iteratively learns to take actions on an environment based on observations in order to solve a given task by maximising a cumulative reward, i.e. taking the impact of the current action on the future performance into account. In

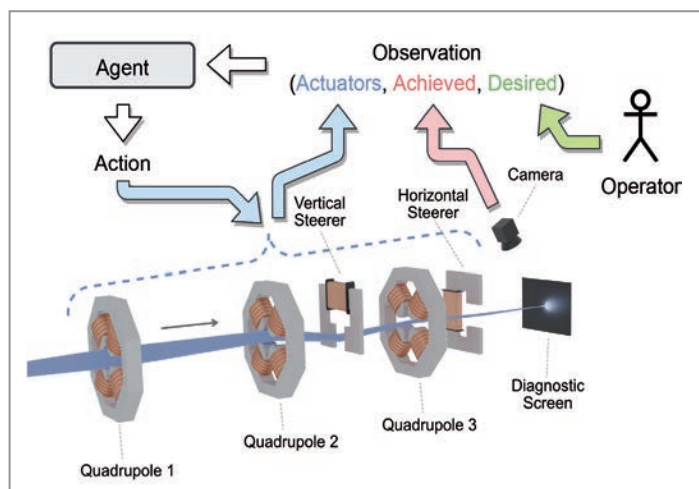

Figure 1  
RL control loop in the ARES experimental area

accelerator operation, the learning is happening by “trying” different actions to find the best strategy that maximises the reward. In recent years, it has been shown that RL techniques are capable of solving tasks with superhuman performance that were previously thought beyond the ability of computers. Within the Autonomous Accelerator project, we focus on transverse beam optimisation at the research linear accelerators ARES [2] at DESY and FLUTE at KIT, with the long-term goal of autonomous start-up.

## Real-world application of RL at a DESY accelerator

ARES, the linear electron accelerator in the R&D facility SINBAD at DESY, provides an excellent test bed for investigating the application of RL to accelerators. During the operation of ARES, the operators are frequently tasked with adjusting the electron beam size and position at a certain point in the accelerator, either for finding a trajectory through the beamline or for setting up the beam for experiments. Automating this procedure, especially the beam setup in the experimental area, would facilitate the operation and is at the same time a well-delimited task for an RL agent.

As a first step, we focus on the adjustment of the transverse beam parameters in the ARES experimental area towards the size and beam position requested by the operator. The agent can act on the beam by adjusting the strength of three quadrupoles for focusing and two

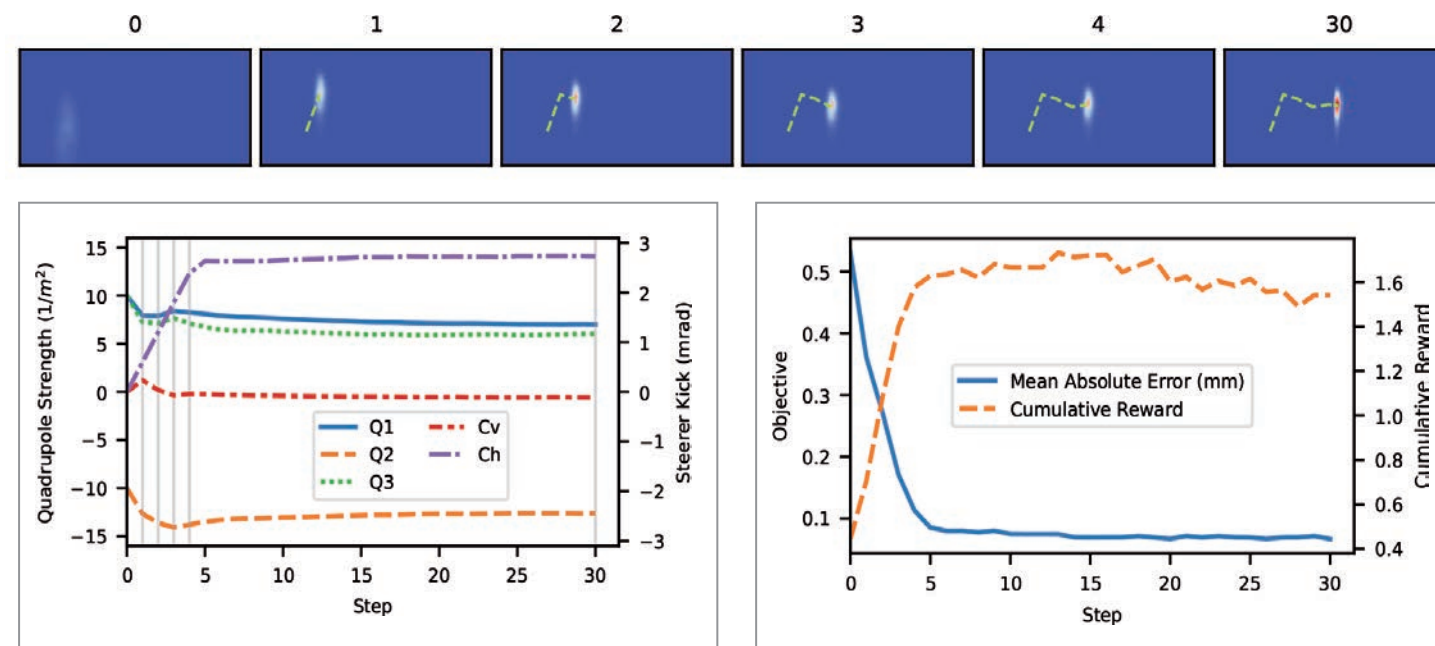

Figure 2

Exemplary run of an RL agent tasked with focusing and centring the ARES beam on a diagnostic screen. The top row shows screen images of different steps during the optimisation process. The dashed line indicates the movement of the beam centre. The steps shown here are depicted as grey vertical lines in the plots below. The corresponding actuator settings (of the quadrupoles Q1, Q2 and Q3 and the corrector magnets Cv and Ch) are displayed in the lower left plot. The lower right plot shows the cumulative reward that the agent received during this run as well as the corresponding mean absolute error, i.e. the difference between the measured and desired beam parameters.

corrector magnets for horizontal and vertical deflection of the electron beam. The agent decides which action to take by observing the beam size and position on a diagnostic screen, the current magnet settings and the desired beam parameters. The complete RL control loop is shown in Fig. 1, which also includes a layout sketch of the ARES experimental area with the quadrupoles and corrector magnets.

Training these RL agents requires many steps ( $>10^6$ ). This means that training on the real accelerator is simply not feasible – a full training would take more than a year of continuous beamtime. Therefore, the agents are trained on a high-speed simulation and can then be deployed on the real accelerator. As no model is perfect, we need to include model imperfections and disturbances, e.g. the unmeasurable and unknown beam entering the experimental area, in the simulation.

## Results and outlook

During various measurement campaigns at ARES, in which the trained RL agents were challenged with different requested beam shapes and positions, the agents showed an overall good performance, as demonstrated by an exemplary run in Fig. 2. While the performance of the agent in this case reached almost human-like levels, only a factor of 2 worse than the resolution limit of the screen, the time for beam adjustment could be significantly

reduced, by a factor of up to 2, as the RL agents rely on a different strategy compared to the human operators. While the agents move all the magnets at the same time, the human operators, in contrast, in a comprehensible human manner, split the problem into first the focusing and then the positioning task, while only using two of the three quadrupoles and only moving one magnet at any time.

While the focusing and positioning problem at ARES is a relatively simple, although useful task, we plan to go further and apply the knowledge gained to other tasks necessary for start-up and tuning at ARES, with the goal to finally support a fully autonomous procedure. Furthermore, we aim to transfer the results and experience to the more complex user facilities operated at DESY, such as FLASH and the European XFEL. First simple tests at FLASH show promising results in simulation, but also point out further challenges.

Contact: Oliver Stein, [oliver.stein@desy.de](mailto:oliver.stein@desy.de)

Jan Kaiser, [jan.kaiser@desy.de](mailto:jan.kaiser@desy.de)

Annika Eichler, [annika.eichler@desy.de](mailto:annika.eichler@desy.de)

## References:

- [1] A. Eichler *et al.*, Proc. IPAC2021, TUPAB298 (2021)
- [2] E. Panofski *et al.*, Instruments 5(3), 28 (2021)



# Attoseconds for accelerators

## Applying carrier suppression interferometer for cavity field detection in accelerators

Modern linear accelerators can produce electron bunches with femtosecond pulse durations. To achieve stable bunch profiles and arrival time conditions for these ultrashort bunches, the radio frequency (RF) cavity fields must be controlled with femtosecond precision in phase and 0.0001% in amplitude. Even with lately improved RF control algorithms and state-of-the-art analogue-to-digital converters, attosecond resolution seemed unobtainable. To further push the limits, DESY's Accelerator Beam Control group applied carrier suppression interferometry using a novel RF front-end together with the baseline system based on MicroTCA.4 technology, yielding a phase noise floor of -205 dBc/Hz and a resolution of 10.76 as. Compared to standard field detectors, the carrier-suppression-based receiver technology, which is especially suited for continuous-wave accelerators, improves the resolution by more than a factor of 500 and allows RF components to be investigated at sub-10 attosecond scale.

### Prototype field receiver based on interferometry

Any continuous RF signal fluctuates in small deviations from its carrier frequency. These deviations are measured by monitoring the phase with respect to a reference signal. The phase fluctuation is typically expressed by the relative power spectral density (in dBc/Hz) for a given offset frequency. In our context, we prefer to express these instabilities in time through  $\delta t = \delta\varphi / 2\pi f_0$ , where  $\delta\varphi$  is the phase fluctuation in a specific offset frequency range, here 10 Hz to 10 MHz, and  $f_0$  is the carrier frequency, here 1.3 GHz.

To measure these tiny RF phase variations  $\delta\varphi$  or times  $\delta t$  on an attosecond scale with RF receivers, understanding the underlying physical noise sources is essential. Typically,

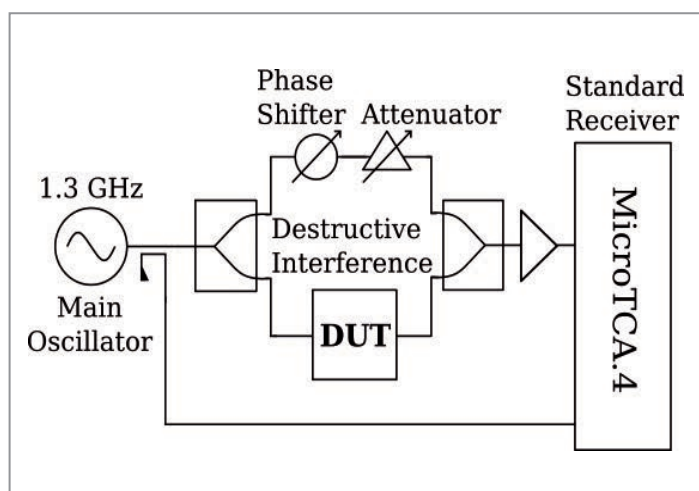

Figure 1  
Simplified block diagram of the carrier-suppression-based receiver

these noise processes are many orders of magnitude smaller than the amplitude of the carrier signal. The dynamic range of state-of-the-art electronics, especially analogue-to-digital converters, is limited, however, and not able to resolve these small noise signals in presence of a large carrier signal [1, 2]. To overcome this limitation, the carrier signal is eliminated by destructive interference. The noise signals of interest that remain can be amplified and finally detected using conventional RF receivers.

This method is known as carrier suppression interferometry. The basic principle is sketched in Fig. 1; Fig. 2 shows the corresponding laboratory setup. In this configuration, a device under test (DUT) can be characterised in terms of its residual phase- and amplitude noise performance. The RF signal from a low-noise RF oscillator is split and recombined. A special adjustable phase shifter and attenuator provide destructive interference after recombination. The electronics are shielded by an aluminium housing and realised using coplanar RF transmission lines. The yellow box in Fig. 2 shows the location of the DUT. To evaluate the setup noise floor, a coaxial cable is used as DUT. After recombination, the noise signal is strongly amplified and subsequently detected using a commercial MicroTCA.4 heterodyne receiver.

### Measurements on the attosecond level

Figure 3 shows the spectral resolution limit of the carrier-suppression-based RF receiver (black curve), compared to the noise floor of the common MicroTCA.4 receiver (blue curve). At 1.3 GHz operating frequency with +30 dBm RF

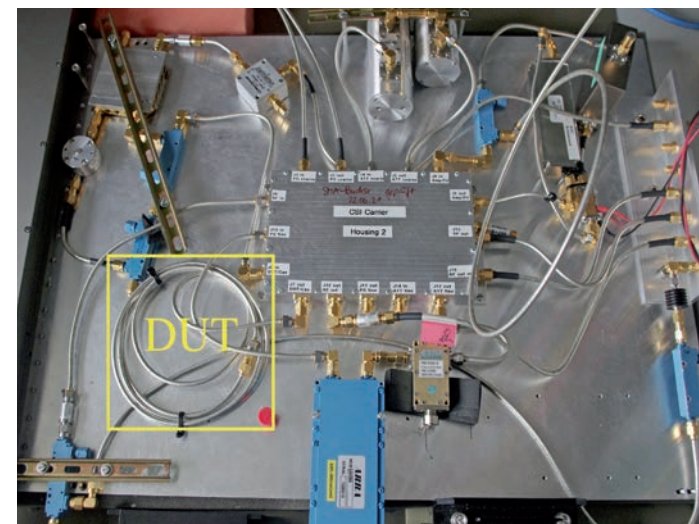

Figure 2  
Setup of a carrier-suppression-based receiver prototype

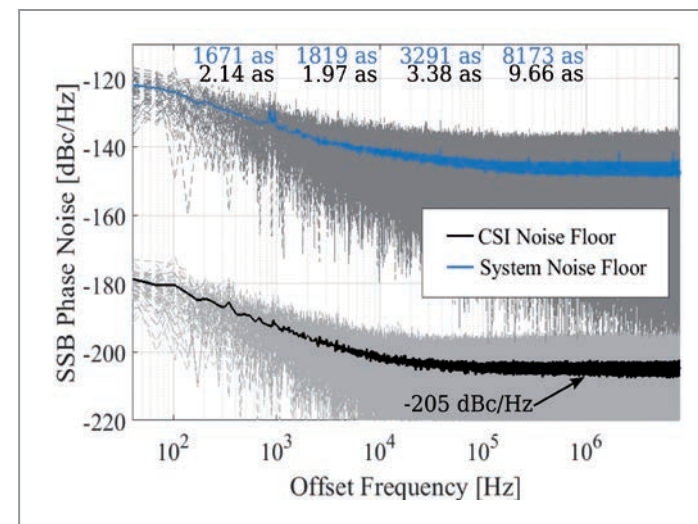

Figure 3  
Phase noise limits for a standard receiver (blue curve) with sub-10 fs time resolution and for the carrier suppression interferometer prototype (black curve) with a time resolution of 10.76 as. The numbers above the graph correspond to the integrated jitter values per frequency decade.

power, a phase noise floor of -205 dBc/Hz and a resolution of 10.76 as  $\approx 4.6 \times 10^{-6}$  deg was achieved within a 1 MHz bandwidth. The resolution was improved by a factor of more than 500. Additionally, the laboratory prototype allowed us to characterise the noise contribution of RF components at their physical limits. RF phase shifters based on different technologies, such as passive relays, micro-electromechanical system (MEMS) switches, barium strontium titanate (BST) capacitors and varactor diode types, were investigated with attosecond resolution.

### Future applications

The RF signal of the reference arm has to follow the RF signal under investigation to achieve destructive interference. Obviously, this is much easier for continuous and uninterrupted RF signals, meaning that the method is much more suitable for a continuous-wave (CW) accelerator operation mode. We therefore plan to apply the carrier suppression receiver technology first in the Cryo Module Test Bench (CMTB) at DESY (Fig. 4), where superconducting cavities can be operated in CW mode. Since the cavity field control system in the accelerating structures typically measures absolute amplitude noise, as opposed to the carrier suppression receiver, which measures residual noise, the amplitude stability of the main oscillators will be very demanding.

Through careful selection of the active components in the phase shifters, the noise of the actuator can be further reduced, enabling single-digit attosecond levels. Applying cross-correlation to such receivers will further improve the



Figure 4  
Cryo Module Test Bench (CMTB) facility at DESY

resolution. Prospectively, this might allow measurements of residual phase- and amplitude noise in the sub-attosecond range.

Contact: Frank Ludwig, frank.ludwig@desy.de  
Louise Springer, louise.springer@desy.de  
Holger Schlarb, holger.schlarb@desy.de

### References:

- [1] F. Ludwig et al., Proc. IPAC2019, THYPLS1 (2019)
- [2] L. Springer et al., IEEE Trans. Instrum. Meas. 71, 1-7 (2022)



# Seismic networks for accelerators

Nothing will escape us in the future

The WAVE initiative is a cooperation between DESY, Universität Hamburg and GFZ Potsdam with the aim to evaluate the potential and foster the use of optical fibres for seismic networks. The intelligent Distributed fibre Acoustic Sensing (iDAS) principle [1] enables acoustic and seismic disturbances to be detected, identified and localised. iDAS is based on the phase coherent detection of Rayleigh backscattered light from short laser pulses transmitted at kHz rate through probing optical fibres. In this way, ten thousands of seismometers can be realised and read out simultaneously, opening up completely new possibilities to mitigate perturbing motions, which degrade accelerator performance and limit experiments on the DESY campus already today.

## Pilot test with iDAS

A first measurement campaign was carried out in May 2021 [2], using a total of 12.6 km of fibre optic cables interconnected on the DESY campus and in the European XFEL tunnel. With a single device, called an interrogator, highly sensitive measuring points can be read out in real time along

the entire fibre every metre. In this first measurement campaign, the linear spatial resolution was set to approx. 10 m. The individual measurements have an accuracy that otherwise only sensitive and expensive seismometers can achieve. In this way, very large amounts of data can be recorded, which should one day be evaluated in real time, if possible.

Vibrations, shocks and linear expansions due to temperature could be measured along the fibre optic cables. We were able to detect earthquakes (Fig. 1), micro-seismic events due to ocean waves and traffic on the streets that run next to the fibre optic lines (Fig. 2). Many technical infrastructures cause vibrations that can easily be detected and assigned, such as air conditioning aggregates, transformers, or vacuum pumps in the accelerator tunnel. For example, in the European XFEL tunnel, prominent sources of interference are the pulse transformers and klystrons of the radio frequency (RF) stations. These send out a characteristic 10 Hz signal with which the accelerator is operated (Fig. 3). The traffic on Rugenbarg street, which crosses the European XFEL tunnel 10 m above it, can also be seen in the data. For the first time, we could also track acoustic waves that propagate along the tunnel away from the source of interference. In this way, external and internal disturbances can be distinguished.

Using the spectral signature, we were able to detect cooling water pumps (characteristic frequency: 24.8 Hz), transformers (50 Hz) as well as a strong source in a few kilometres distance causing interrupted periods of 5.2 Hz, which has not yet been identified.

With the help of a mobile vibrating truck (Vibro-Truck) [2], the subsoil was acted on at certain points. The wave propagation in the ground was then recorded with the iDAS measuring method in addition to conventional methods

(seismometers and geophones). From the data, the properties of the subsurface can be determined using sophisticated algorithms that allow the development of transfer functions to predict perturbations. In the future, ideas for novel algorithms based on machine learning techniques are to be developed in collaborations with several universities in Germany within the action plan ErUM-Data of the German Federal Ministry of Education and Research (BMBF).

## Future applications

In the future, it may be possible to use the measured waveforms to directly identify where suspected interferers are located. The technology has incredible potential. Geologists at the university could study the subsurface conditions in the district, scientists in other disciplines could investigate civilisational influences such as traffic and the rhythm of life. With this measurement technique, we will always have an ear on the ground.

We also see further applications for accelerators, photon beamline experiments and sensitive microscopes (e.g. cryo

or atomic force microscopes). Using the iDAS method, we cannot only identify, localise and then eliminate sources of interference, but also use the measurement signals directly for data gating or feedback control. The sensitivity is high enough that even the influences of ocean waves can be quantified. These influences are also observed as disturbances in the timing of the European XFEL. Maybe, in future, the iDAS signals could be used for compensation to allow for higher precision of the experiments.

Today's computing capabilities in combination with modern artificial intelligence algorithms will enable these large data sets to be processed in real time and allow for applications that we cannot even think of at the moment. In addition, the interrogator technology has not yet been fully exploited, and special fibres (instead of standard single-mode optical fibres) could be used to greatly increase the sensitivity.

In infrastructure projects, such as the planned Science City Hamburg Bahrenfeld, we expect more and more fibre optic cables to be used for seismic monitoring for prototyping capabilities in smart cities. In the end, an increasingly dense network will emerge from an abundance of measuring points, whose data have previously unimagined potential. We want to continue to explore these possibilities in the future.

Contact: Markus Hoffmann, [markus.hoffmann@desy.de](mailto:markus.hoffmann@desy.de)  
Holger Schlarb, [holger.schlarb@desy.de](mailto:holger.schlarb@desy.de)

## References:

- [1] Tom Parker *et al.*, First Break 32 (2014)
- [2] <https://www.uni-hamburg.de/en/newsroom/forschung/2021/0616-vibro-truck-seismisches-messnetzwerk.html>

Figure 3  
Spectra for all positions along the European XFEL tunnel during operation. The 10 Hz frequency ladders where the RF stations are located can clearly be seen.

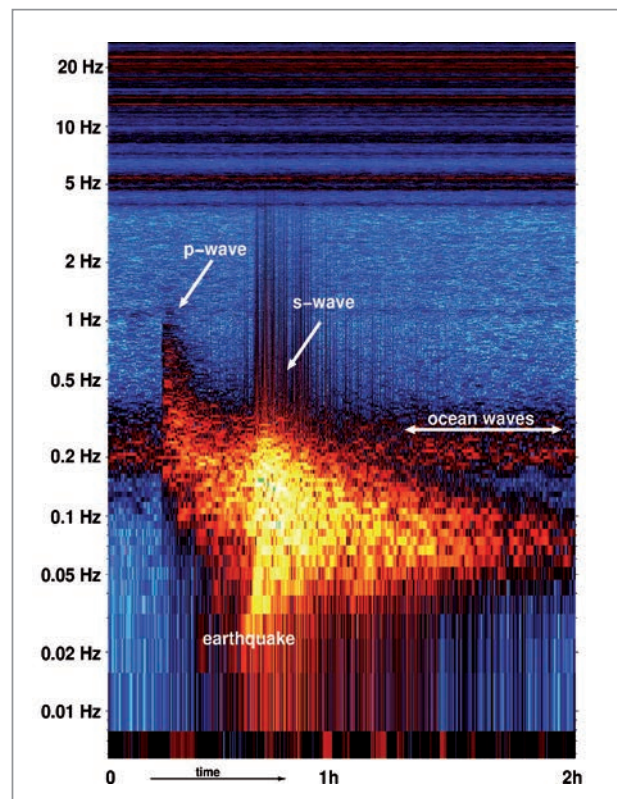
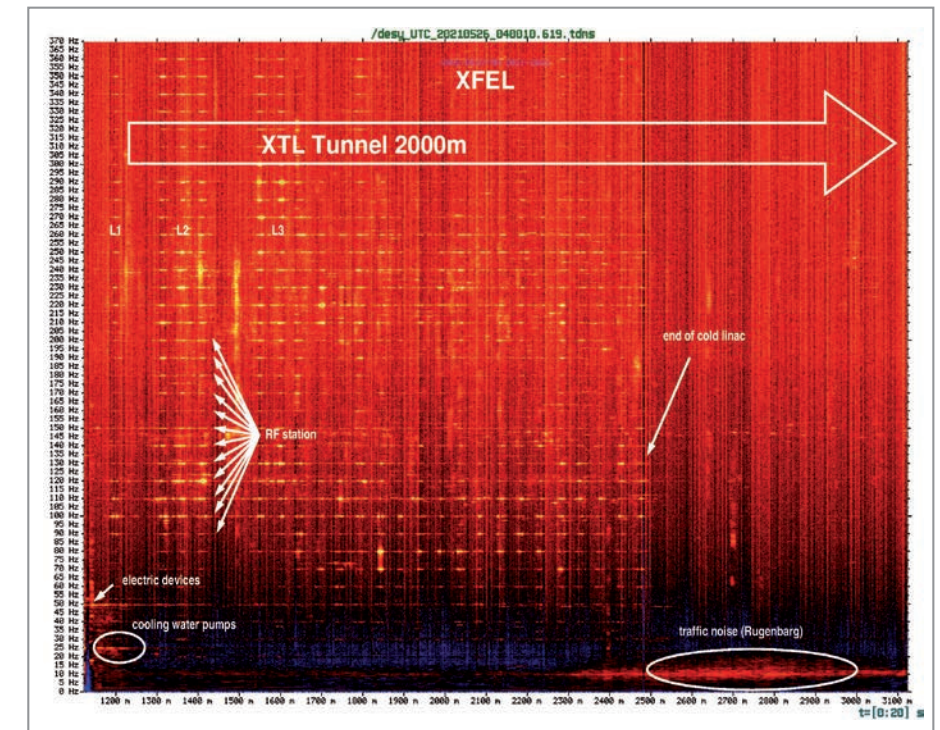

Figure 1  
Spectrogram of an earthquake detected with the optical fibres. It originated in China on 21 May 2021 and had a magnitude of 7.3. The band at approx. 0.2 Hz stems from ocean waves.

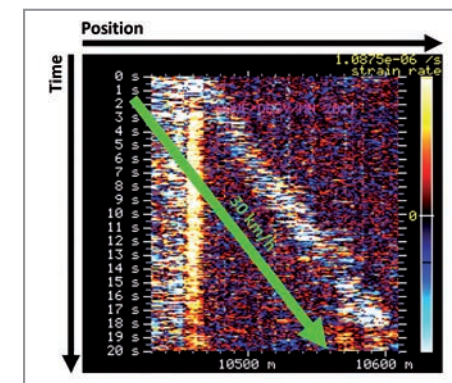

Figure 2  
Car traffic on the DESY campus: signature of a car passing by (diagonal line from left to right)



# Taming Cyclopes

Mixed-reality solutions for laser safety in high-energy laser labs at DESY

In the quest for highly energetic, multispectral lasers for next-generation synchrotrons at DESY, researchers often experience conflicts between the safety and usability of conventional laser safety equipment. Starting in 2023, laser laboratory safety regulations will require researchers to use laser safety glasses with only 6% visible-light transmission. Mixed-reality headsets could provide a solution, offering eye safety for Class IV laser labs *without* hampering users' faculties. In fact, mixed-reality headsets can improve workflow by overlaying Distributed Object-Oriented Control System (DOOCS) panels and 3D computer-aided design (CAD) models directly onto laser workbenches. To this end, in 2021, the Human-Computer Interaction group at Universität Hamburg and the DESY Laser Science and Technology group conducted a first-of-its-kind pilot study for the use of mixed-reality headsets for laser eye safety.

## Replacing traditional safety goggles – safety first

Conventionally, laser safety goggles use optical filters to protect users' vision by reducing the intensity of laser light entering the human eye. The level of laser light attenuation is determined using the wavelengths and intensity of the laser – for working in a laser lab, regulations call for over 94% of visible light to be filtered out, rendering researchers effectively blind. However, video see-through head-mounted displays (VST-HMDs) enable users to perceive

the real-world environment through virtual-reality (VR) headsets without directly exposing users' eyes to laser radiation. A fully encapsulated commercial VR headset, such as the Oculus Quest or Vive Focus, filters out 100% of all external light, making it the equivalent of a fully opaque eye shield, a better-than-required solution for laser safety.

A VST-HMD setup was developed by the Human-Computer Interaction group at Universität Hamburg and tested at the laser laboratories of the Laser Science and Technology group at DESY. The headset was equipped with a stereo camera mounted at eye level on the face shield, providing a visual pass-through of the laboratory in full colour and high resolution. The headset's native black-and-white camera ensured redundancy for safety in case of primary-camera failure.

## The prototype – human-centred system design and development

The design and development process of the prototype (see Fig. 2 for a system overview) followed a human-centred design (HCD) [1] approach, where the design of interactive systems relates closely to the actual human tasks and activities that the system assists with. Significant work was carried out to increase the frame rates and data transmission rates to promote a seamless visual environment and avoid headset-induced vertigo ("cybersickness"). Users also required minor coaching to promote brain acclimatisation to the visual feed-through – a subtle effect caused by the camera position offset from the users' real eyes.



Figure 1  
Researcher wearing a VST-HMD for laser safety

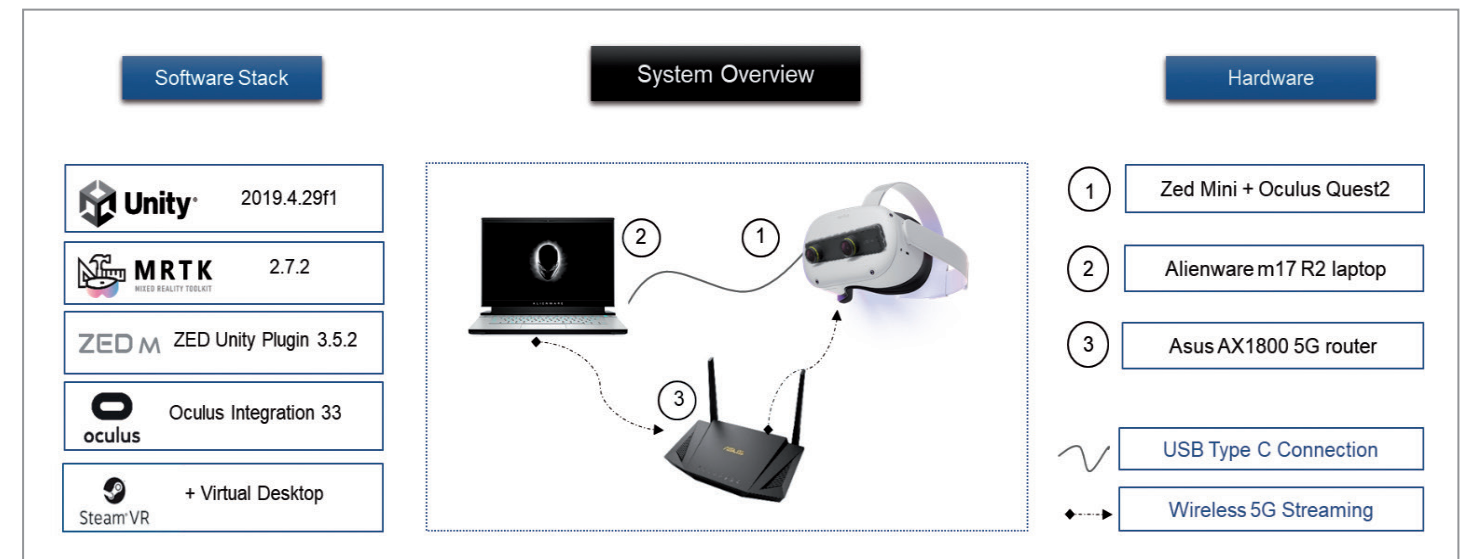

Figure 2  
System overview and technology stack of the prototype VST-HMD for laser eye protection

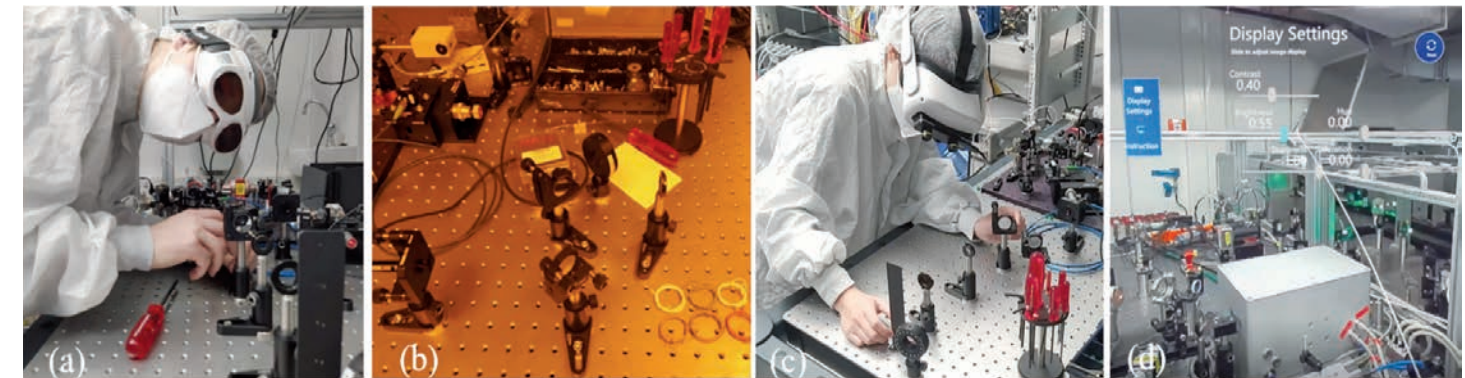

Figure 3  
(a) User operating an optics setup wearing conventional laser safety goggles. (b) View through the conventional laser safety goggles with 70% of visible light filtered out. (c) User aligning an optical setup wearing a VST-HMD. (d) View through the VST-HMD prototype with a virtual 3D model of the optical setup.

## DESY pilot study

The prototype was evaluated by 18 participants, including 14 laser and optics experts. The user study involved the completion of complex tasks, such as optical alignment, visual inspection of damaged optics and machine control, as shown in Fig. 3, as well as surveys for usability, control and subjective feelings of safety and comfort.

The prototype averaged a score of 77.91 for usability, which translates to the 80<sup>th</sup> percentile, i.e. the perceived usability of the system developed by Universität Hamburg and DESY is higher than for 80% of the products considered in a review of 500 studies by J. Sauro [2], despite the specialised tasks required of the users in the DESY study. This excellent usability score, when combined with the laser eye safety conferred by the VST-HMD, shows clear benefit to implementing the system, especially in laboratories that present a usability challenge for traditional laser protection glasses (e.g. laser laboratories containing multi-spectral / highly broadband Class III and Class IV laser systems).

## Future research

Future research begins with improving mobility: converting the laptop-and-goggles prototype to a mobile wireless solution. Research efforts are also directed towards further reducing cybersickness, improving perceived resolution and reducing hardware redundancy. Beyond meeting and exceeding laser safety and usability standards, the project is also implementing capabilities to improve the optics workflow: overlaying DOOCS control panels, DESY accelerator logbooks and 3D CAD models from the DESY TeamCenter repository onto work surfaces for seamless integration of digital and optical laboratory tasks.

Contact: Ke Li, [ke.li1@desy.de](mailto:ke.li1@desy.de)  
Aradhana Choudhuri, [ara.choudhuri@desy.de](mailto:ara.choudhuri@desy.de)

## References:

- [1] R. Kling, S. Leigh Star, SIGCAS Comput. Soc. 28, 22-29 (1998)
- [2] J. Sauro, *A practical guide to the system usability scale: Background, benchmarks & best practices*, Measuring Usability LLC (2011)



# European XFEL – more safety, more power!

Fluorescence light helps ease constraints for European XFEL operation

The enormous energy density of the X-ray pulses generated by the European XFEL X-ray free-electron laser puts components and safety requirements to a severe test. These pulses can vaporise any material in the focus and thus endanger accelerator or safety components. Because of this, a complicated system of constraints on the operating parameters was introduced to ensure safety. To enable the possibility of easing these restrictions, the DESY Radiation Protection group has developed a burn-through monitor system to reliably detect possible burn-through events caused by the European XFEL beam.

## European XFEL pulses and constraints

The X-ray pulses of the European XFEL are generated in a photon energy range from 0.5 to about 30 keV. Pulse trains containing up to 3000 pulses with a maximum repetition rate of 4.5 MHz are produced ten times per second. Each pulse is about 100 fs short and may possess energy on the order of millijoules. Furthermore, focused beam sizes can reach 10  $\mu\text{m}$  or smaller, and this combination can produce energy densities high enough to ablate

material. This places accelerator and safety components at risk of burn-through (Fig. 1).

Until summer 2021, the integrity of safety components was ensured by restricting the operating parameters. Since the burn-through process depends strongly on the wavelength, pulse energy and focus size of the FEL beam, this resulted in a very complicated set of tables with different constraints for the different self-amplified spontaneous

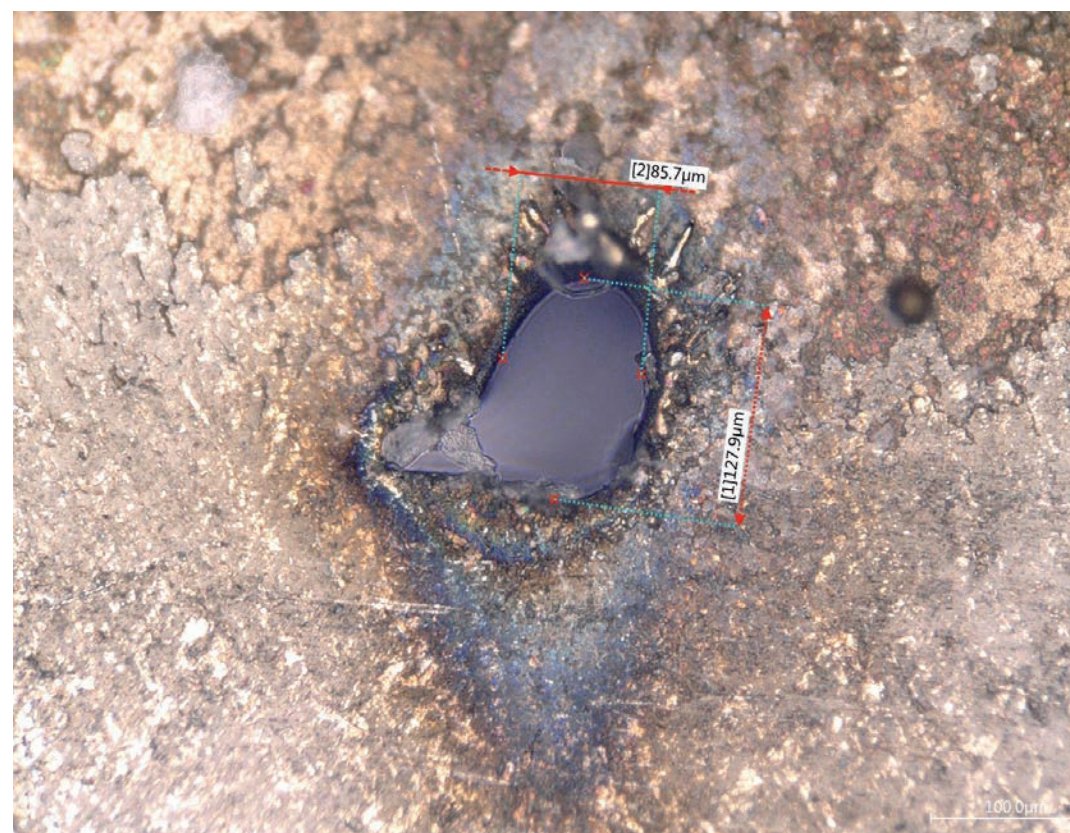

**Figure 1**  
Microscope image of a burn-through hole in a steel cap generated by a 1.5 keV FEL beam

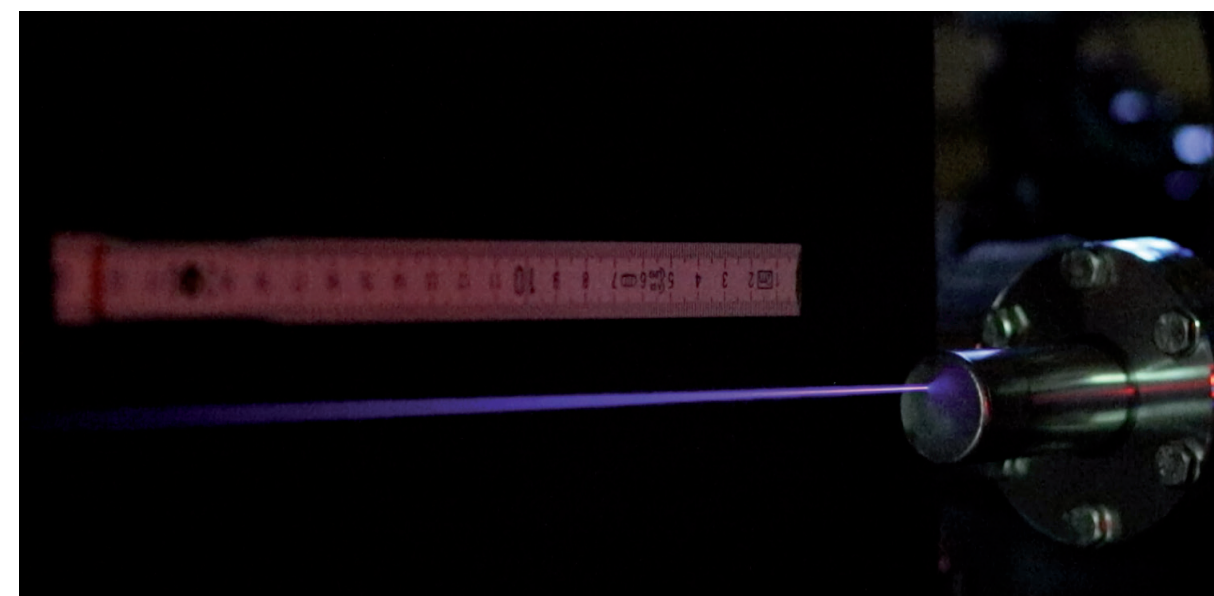

**Figure 2**  
2.6 keV X-ray pulses generating fluorescence light in air at the European XFEL's SQS beamline

emission (SASE) areas, which limited operation. A technical solution for easing these constraints was needed.

## Fluorescence light

The task was thus to find a way to reliably detect an event when the European XFEL beam burns through safety components, such as beam shutters or beam stops.

Previous systems were based on the loss of vacuum caused by a burn-through. However, because of the small beam diameters of the European XFEL beam, it could not be guaranteed that the holes created would cause a significant enough loss of vacuum.

An appropriate measurement principle was therefore required. Here, the property of X-ray pulses to generate fluorescence light in air helped (Fig. 2). The spectrum produced is dominated by the nitrogen component and lies in the wavelength range from 200 to 400 nm. The states excited by the X-ray pulses de-excite in the range of nanoseconds by emitting fluorescence light [1]. Developing a burn-through monitor system by detecting light in this wavelength range and within this time resolution thus became the goal.

## Burn-through monitor system

As a safety system, the burn-through monitors are equipped with two detector systems operating in parallel. A multipixel photon counter (MPPC detector) and a photomultiplier tube (PM detector) with high response probabilities were selected as suitable detectors for detecting air fluorescence light. To check the function of the detectors regularly, each detector is tested with an LED pulse every ten minutes. The two detectors are controlled by an

electronics unit, which had already proven itself with the PANDORA radiation monitoring system at the European XFEL. These electronics transmit the signals to a safety programmable logic controller (PLC). In case of an alarm due to a burn-through or a failed self-test, the European XFEL accelerator is switched off [2].

## More freedom of choice of operating parameters

By means of a combination of measurement campaigns on the properties of the fluorescence light, tests of the ablation of material with the European XFEL pulses, proofs of principle for the different wavelength ranges and calibration of all burn-through monitors, the DESY Radiation Protection group was able to successfully commission the complete burn-through monitor system. In the winter shutdown 2019/20, the system was installed and certified by the Technical Inspection Association (TÜV). The operation so far has been very reliable, and the measurement principle has been successfully adopted for the active beam stops in the European XFEL experiment hutches.

In combination with other safety requirements, the burn-through monitor system was an essential step towards easing the constraints on European XFEL operation in summer 2021 to a maximum beam power of 40 W at each SASE beamline.

Contact: Sven Zander, [sven.zander@desy.de](mailto:sven.zander@desy.de)

## References:

- [1] T. Liang *et al.*, "Air fluorescence spectral measurements at XFEL FXE", DESY Internal Report D3-12 (2020)
- [2] W. Clement *et al.*, "XFEL - Burn Through Monitor System", European XFEL Technical Report (2020)



# The quality assurance programme

Planning and implementation to strengthen failure analysis and operational support

The Accelerator Division's quality assurance (QA) programme, launched in 2019, has the long-term goal of establishing a QA system that focuses on managing processes and knowledge and on stabilising and increasing the availability of DESY's accelerator facilities. The development of a knowledge database and the establishment of a process management system support the implementation of the QA programme and are important organisational steps towards the realisation of the digitalisation strategy DIGITAL DESY. A strong quality management (QM) network serves professional exchange and enables synergy effects.

## Vision, mission and QM guideline

A vision, mission, goals and QM guideline were developed for the QA programme. According to these, the vision of highly reliable accelerator operations, which enable our international customers – our users – to conduct top-level research, is supported by managing processes and knowledge (mission). The long-term goal is to establish a practised QM system in the accelerator area. The QM guideline provides orientation in the realisation of the vision and mission and focuses on customers, suppliers, employees, existing QM initiatives and the competitiveness of the DESY accelerators.

## Implementation and support by quality officers

To implement the QA programme, a QM officer was appointed for the Accelerator Division and pilot groups were selected, each of which was assigned a quality officer who focuses on quality-related tasks within the group. At the end of 2019, an in-house training of the Deutsche Gesellschaft für Qualität (DGQ) took place at DESY to introduce the prospective quality officers to QA basics and methods. Building on this, a QM training programme was established for the continuous further training of the quality officers. To promote effective cooperation, QM roles and tasks were developed for the Accelerator

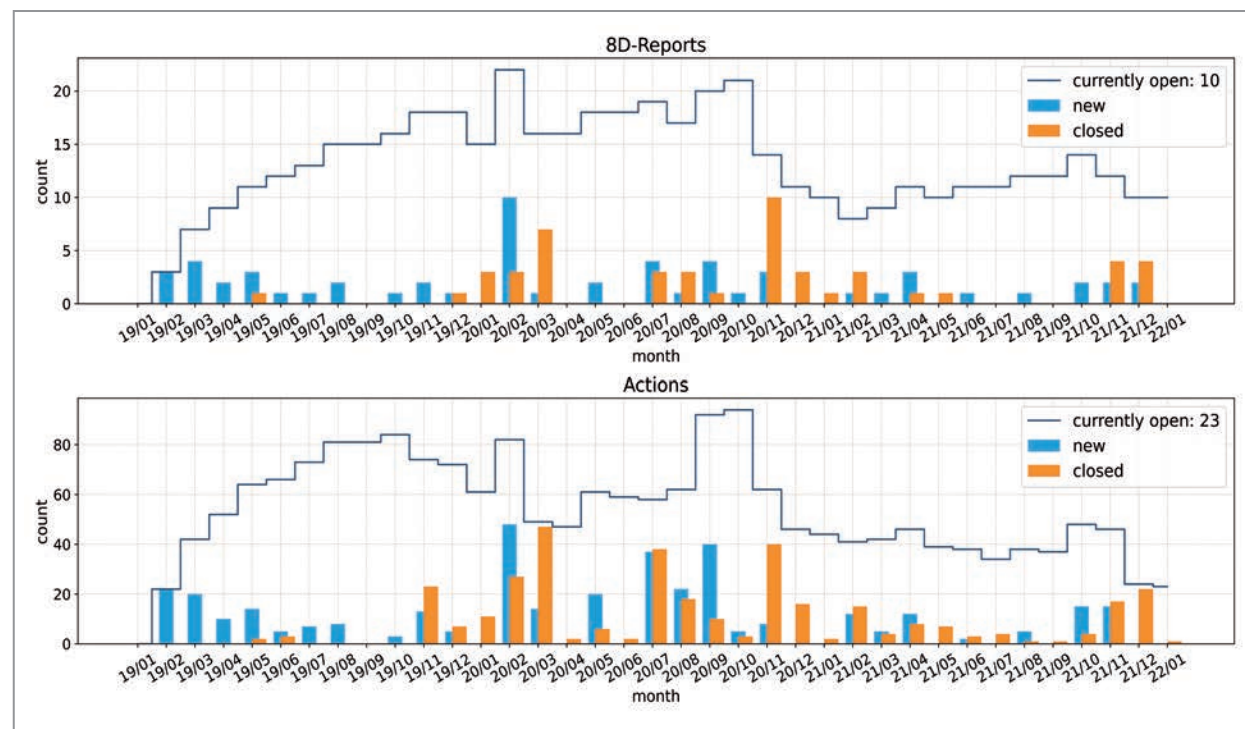

Figure 1 All new 8D reports started and completed each month (top), associated measures (bottom) and cumulative number of reports and measures currently open

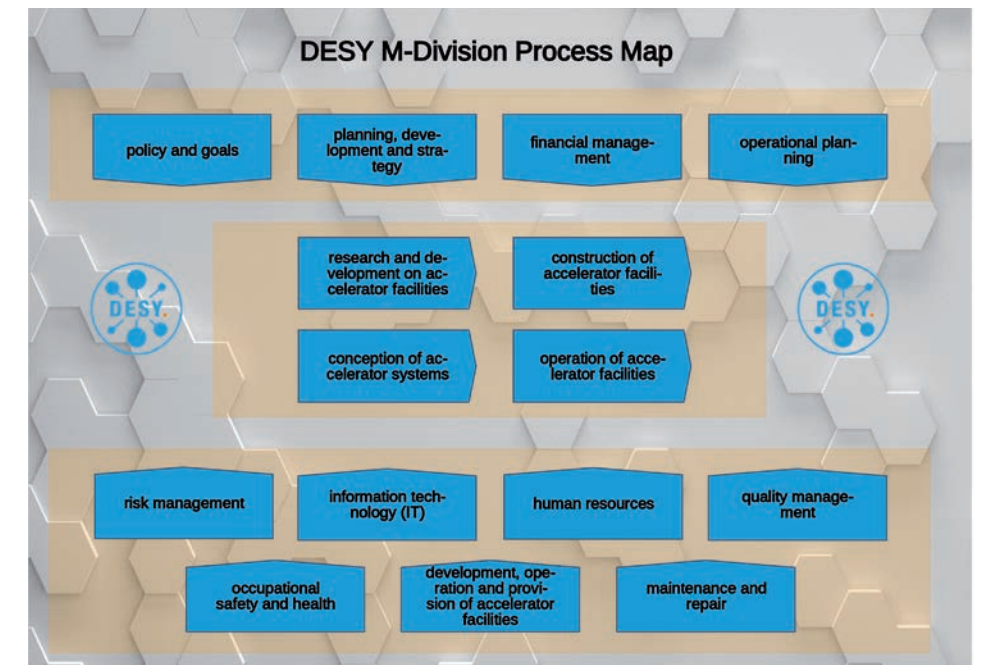

Figure 2 Example process map with Accelerator Division (M-Division) processes created as part of the ADONIS evaluation

Division management, group leaders, group members and quality representatives.

## QM network

The DESY Quality Management team is setting up and participating in various QM networks. In addition to promoting professional exchange and synergy effects, these are intended to strengthen the quality mindset at DESY. The DGQ QM network provides the basis for this. On DESY's initiative, a Helmholtz Quality Circle is being established, which is currently in its initial phase and offers the opportunity for professional exchange with other research institutions. DESY exchange formats for QM and QA are in the planning phase.

## Projects and services

Various QM projects have been launched, e.g. for the documentation of technical systems and processes, the application of QM methods and the evaluation of software. A robust project management system has been set up to control the projects and is continuously being developed. A progress report on all QM projects is provided to the management of the Accelerator Division on a quarterly basis. The Quality Management team has also built up a catalogue of services to provide operational support to the groups in the Accelerator Division. This is being continuously expanded and includes, among other things, failure monitoring (8D reporting), process acquisition and modelling, failure mode and effects analysis (FMEA) and support in planning and conducting reviews. Since the implementation of the 8D method in the European XFEL Accelerator Coordination team at DESY at the beginning of 2019 (Fig. 1), the number of root causes with a downtime of

more than 4 h and thus the number of failure reports have been visibly reduced by the end of 2021.

At the end of 2020, a dedicated working group was established on the initiative of the Quality Management team to analyse and mitigate the consequences of power glitches and voltage dips. Quarterly reports to the management of the Accelerator Division and the machine coordinators contain the results of the discussed measures against power glitches, the current power glitch statistics and the status of action monitoring. The power outages that occurred in August 2021 were thoroughly investigated, and a comprehensive report was prepared, summarising the consequences of the power outages for the accelerator and test facilities and presenting a strategy for mitigation.

## Management of processes and knowledge

The establishment of a knowledge database (qBase) in the Accelerator Division is a long-term QM project that initially focuses on the digitalisation of failure management. The acquisition of accelerator operation statistics, the management of maintenance and repair work, spare parts and measuring equipment, FMEA and document management are further options for implementation in qBase. The next steps are in preparation. The Quality Management team uses the ADONIS business process management system to model and manage processes in order to present them in a clear, transparent and up-to-date manner. As part of the ADONIS evaluation, a process map (Fig. 2) was created, showing the most important processes in the Accelerator Division.

Contact: Frank Eints, [frank.eints@desy.de](mailto:frank.eints@desy.de)  
Siegfried Köpke, [siegfried.koepke@desy.de](mailto:siegfried.koepke@desy.de)



# Cryogenics for the ALPS II experiment

“Light-shining-through-a-wall” experiment passes next milestone

The aim of the “light-shining-through-a-wall” experiment ALPS (Any Light Particle Search) at DESY is to detect extremely light particles – weakly interacting slim particles (WISPs) – that could make up dark matter. Potential WISP candidates are axion-like particles or hidden-sector photons. The experimental setup uses 24 recycled superconducting dipole magnets of DESY’s former HERA electron–proton collider, together with renewed cryogenics and vacuum systems, laser beams and an extremely sensitive detector, to search for axion-like particles. The experiment relies on the principle that in a strong magnetic field, photons – i.e. particles of light – could be transformed into these mysterious particles and then back again. The cryogenics and vacuum systems for ALPS II were finished in early autumn 2021, culminating in a first successful cooldown of the ALPS II magnet string in December 2021.

## Weakly interacting slim particles

Open questions in elementary particle physics, astrophysics and cosmology might be solved by the existence of very lightweight WISPs. Such new constituents of nature could very well explain the dark matter in our universe as well as some puzzling observations concerning the evolution of stars and the propagation of light in interstellar and intergalactic space. They might even be related to the phenomenon of dark energy.

The best-known archetypal of these WISPs is the quantum chromodynamics (QCD) axion, already predicted more than 40 years ago to explain the conservation of the charge conjugation parity (CP) symmetry in QCD. The axion and other WISPs are pseudo Nambu–Goldstone bosons related to global symmetry breakings at energies many orders of magnitude above the reach of any realistic future collider experiment. Thus, a discovery of WISPs would give insight into particle physics at extremely high energies.

However, it is just this relation that complicates the detection of WISPs very much. In general, the interaction of WISPs with Standard-Model constituents is suppressed by the high energy scale where the WISP-related symmetry breaking takes place. Only very feeble interactions are expected.

## Light shining through a wall

The “light-shining-through-a-wall” experiment ALPS II is being commissioned in the straight section of the HERA tunnel around the Hall North. In a first part of the experiment, WISPs might be generated by light shining into a strong magnetic dipole field. A light-tight barrier, easily surpassed by any WISP, shields the second compartment, where WISPs might convert back to photons, again in a strong magnetic dipole field. ALPS II will be the worldwide most sensitive experiment looking for axion-like particles and other WISPs in a model-independent fashion:



Figure 1

ALPS II superconducting dipole string with renewed cryogenics and vacuum systems in the HERA North area

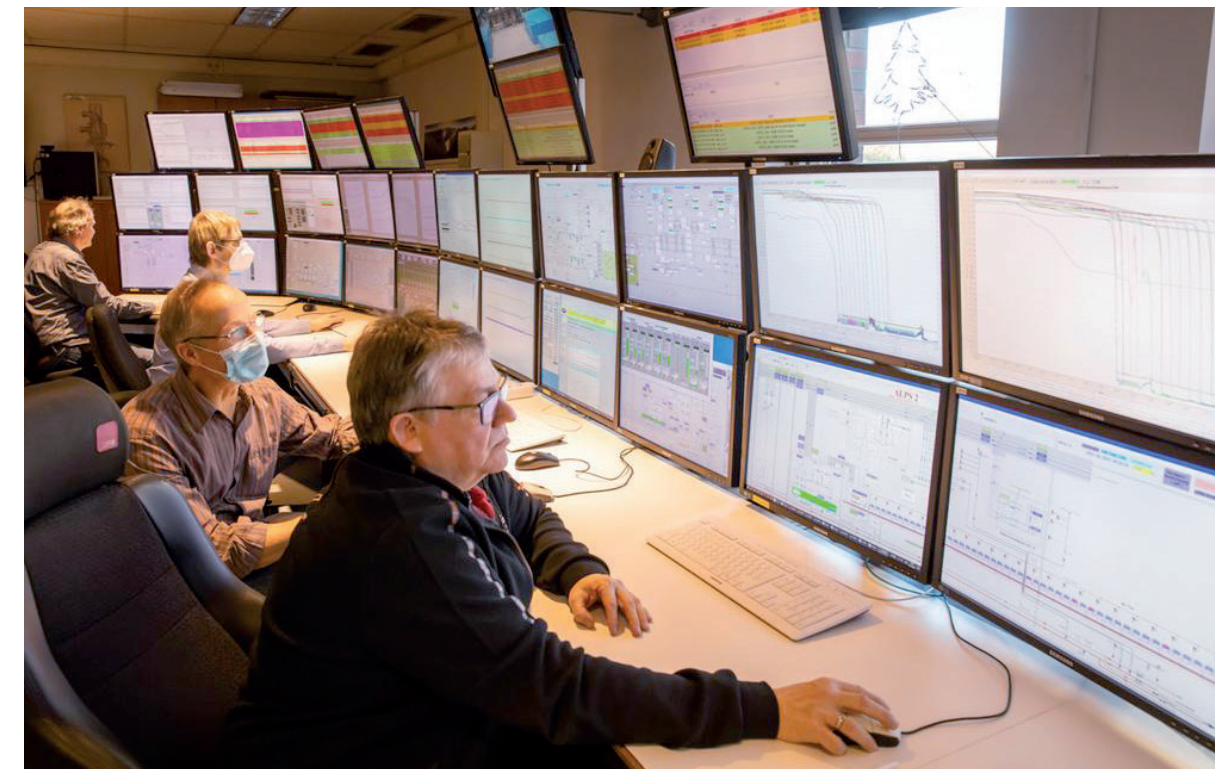

Figure 2

Operators from the Cryogenics and Superconductivity group steering the first cooldown of ALPS II

Compared to previous, similar experiments, it will increase the signal rate by 12 orders of magnitude.

With its HERA infrastructure, DESY offers unique site options for such an experiment. The long straight sections of the HERA tunnel provide an ideal place for installation of a long string of 24 superconducting dipole magnets originally built for the HERA proton accelerator (Fig. 1). The first half of the magnets are arranged in a straight line enclosing a vacuum tube in which a high-intensity laser beam bounces back and forth. If a photon turned into an axion, it would be able to pass through an opaque wall located at the end of the line of magnets. Having passed through it, the axion could then change back into light as it travelled down an almost identical magnetic path on the other side, and this photon would then be captured by the detector at the end.

## Quest for a sensible sensitivity with renewed cryogenics and vacuum systems

In order to reach sensitivity to axion-like particles as indicated by astrophysics phenomena, a complex optical system with high-finesse mode-matched optical resonators is built around the magnet string. Here, ALPS II strongly relies on technologies developed for the gravitational-wave interferometers GEO600 and LIGO. However, using such optics requires straightening the HERA dipoles to increase the horizontal beam tube aperture from 35 mm to about 50 mm [1].

R&D towards ALPS II was started by an international collaboration in 2012. The first dipole magnet for the ALPS II

experiment was straightened and afterwards quenched in the old HERA magnet test facility in 2015, the last of the required magnets was straightened and tested in 2020. In 2018, the ALPS II site in the HERA North area was cleared, and work started to reactivate the old HERA cryogenic system and adapt it to the requirements for the cryogenic supply of the 24 superconducting magnets in the straight tunnel section around the HERA Hall North. In parallel, the old HERA cryogenic controls had to be completely renewed. The first magnet was installed in October 2019, and the last one was put in place one year later. The cryogenics and vacuum systems were finished in early autumn 2021.

After the last of the magnets was installed in the tunnel, the superconducting cables, cryogenic pipes and vacuum insulation were connected, and the modules were linked to the power supply and the cryogenic system to be filled with liquid helium. After the mandatory pressure test, the helium valves were opened at the end of November 2021. In mid-December, the stable state of  $-269^{\circ}\text{C}$  was reached (Fig. 2). The mode of operation of the cryogenic cooling is the same as for HERA: The magnetic coils are completely surrounded by single-phase supercritical helium, which is kept cold by controlled evaporation of helium. Everything is on track for a first science run in 2022.

Contact: Detlef Sellmann, [detlef.sellmann@desy.de](mailto:detlef.sellmann@desy.de)  
Axel Lindner, [axel.lindner@desy.de](mailto:axel.lindner@desy.de)

## Reference:

[1] C. Albrecht *et al.*, *EPL Tech. Instrum.* 8, 5 (2021)



# State-of-the-art beam diagnostics

Detail of the PolariX X-band transverse deflecting structure (TDS) cavities installed at ARES (more info: see p. 74)

Picture: Florian Burkart, DESY

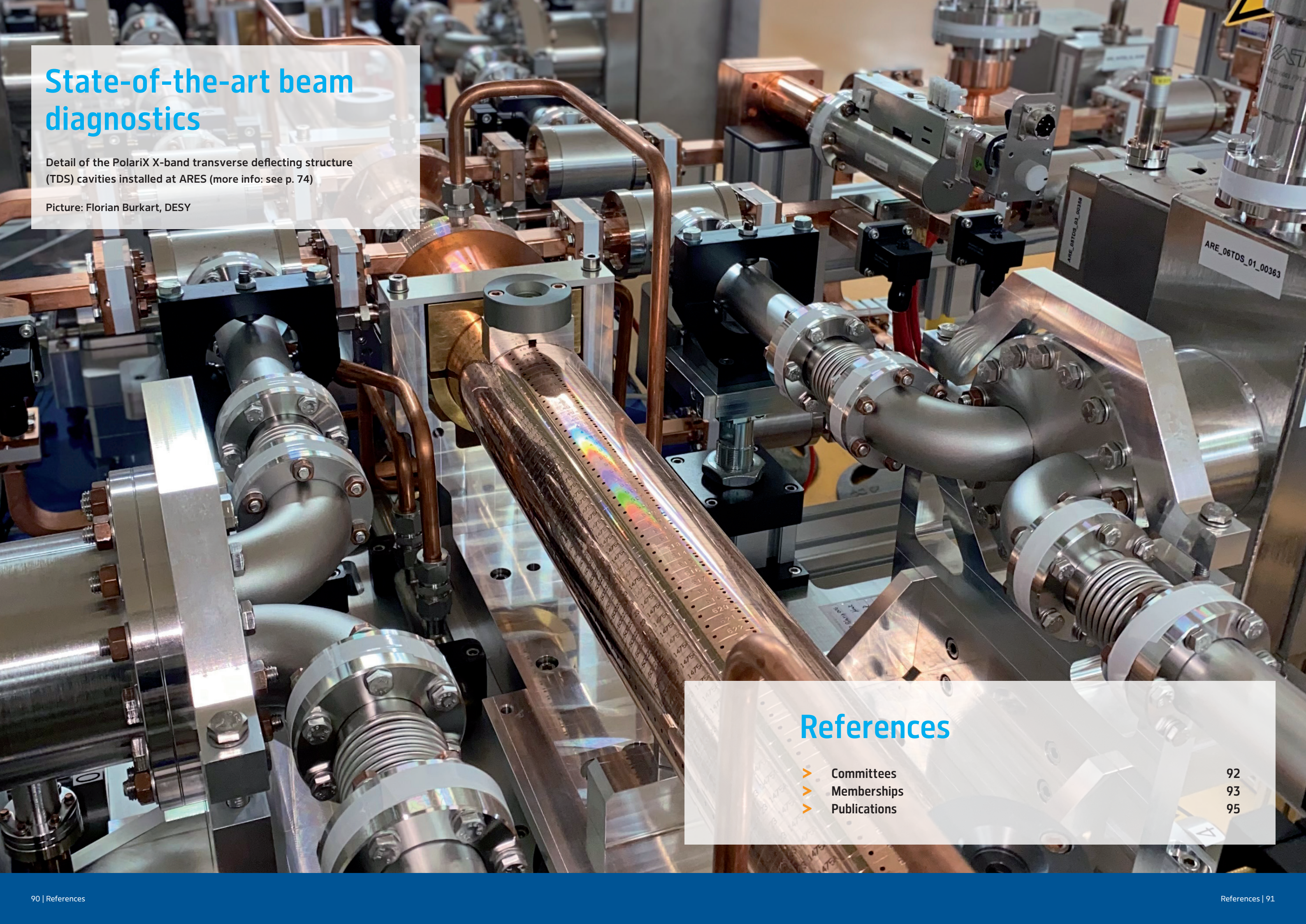

## References

➤ Committees	92
➤ Memberships	93
➤ Publications	95



## DESY Board of Directors

**H. Dosch**  
(Chairman of the DESY Board of Directors)

**W. Leemans**  
(Accelerator Division)

**E. Weckert**  
(Photon Science Division)

**T. Behnke**  
(Particle Physics Division – Interim)

**C. Stegmann**  
(Astroparticle Physics Division)

**C. Haringa**  
(Administrative Division)

**A. Willner**  
(Chief Technology Officer)

## DESY Scientific Committee

Elected members from 1 May 2021:

M Division  
**N. Baboi** (DESY)  
**M. Bieler** (DESY)  
**F. Burkart** (DESY)  
**M. Czwalińska** (DESY)  
**A. Eichler** (DESY)  
**K. Flöttmann** (DESY)  
**K. Honkavaara** (DESY)  
**C. Kluth** (DESY)  
**G. Kube** (DESY)  
**L. Lilje** (DESY)  
**S. Pfeiffer** (DESY)  
**H. Schlarb** (DESY)  
**S. Schreiber** (DESY)  
**M. Vogt** (DESY)

**O. Seeck** (DESY)  
**K. Tiedke** (DESY)  
**M. Tischer** (DESY)  
**S. Toleikis** (DESY)  
**R. Treusch** (DESY)  
**H.-C. Wille** (DESY)

FH Division  
**C. Apfel** (DESY)  
**J.-H. Arling** (DESY)  
**I. Bloch** (DESY)  
**M. Diehl** (DESY)  
**D. Eckstein** (DESY)  
**I. M. Gregor** (DESY)  
**S. Heim** (DESY)  
**A. Lindner** (DESY)  
**J. List** (DESY)  
**I. Melzer-Pellmann** (DESY)  
**F. Poblitzki** (DESY)  
**A. Ringwald** (DESY)  
**T. Schörner-Sadenius** (DESY)  
**S. Spannagel** (DESY)  
**P. van der Reest** (DESY)

FS Division  
**S. Bari** (DESY)  
**M. Beye** (DESY)  
**R. Döhrmann** (DESY)  
**S. Düsterer** (DESY)  
**J. Garrevoet** (DESY)  
**H. Graafsma** (DESY)  
**F. Hakanpää** (DESY)  
**T. Laarmann** (DESY)  
**E. Plönjes-Palm** (DESY)  
**N. Schirmel** (DESY)  
**H. Schulte-Schrepping** (DESY)

Zeuthen – AP Division  
**S. Blot** (DESY)  
**A. Haupt** (DESY)  
**J. van Santen** (DESY)  
**S. Zhu** (DESY)

## Machine Advisory Committee (MAC)

**O. Brüning** (CERN, CH) Chair, till November 2021  
**J. Chavanne** (ESRF, FR)  
**F.-J. Decker** (SLAC, USA)  
**Á. Faus-Golfe** (IFIC, Valencia, ES), till November 2021  
**E. Gschwendtner** (CERN, CH)  
**M. Minty** (BNL, USA) Chair, since November 2021  
**P. Ratoff** (Univ. Lancaster, UK)  
**F. Sannibale** (LBNL, USA)  
**P. Tavares** (MAX IV Lab, SE), since May 2021  
**S. Thorin** (MAX IV Lab, SE), since November 2021  
**A. Wolski** (Univ. Liverpool, UK), till November 2021

## Laser Advisory Committee (LAC)

**J. Zuegel** (LLE, USA)  
**M. Danailov** (Elettra Sincrotrone Trieste, IT)  
**T. Dekorsy** (DLR, DE)  
**A. Fry** (SLAC, USA)  
**C. Le Blanc** (Ecole Polytechnique, LULI, FR)  
**E. Springate** (STFC, UK)

V Division  
**N. Hundoegger** (DESY)  
**I. Mahns** (DESY)  
**C. Porthun** (DESY)  
**D. Völker** (DESY)  
**T. Zoufal** (DESY)

Leading Scientists  
**R. Aßmann** (DESY)  
**R. Bartolini** (DESY)  
**D. Berge** (DESY)  
**K. Borras** (DESY)  
**R. Brinkmann** (DESY)  
**F. Calegari** (DESY)  
**H. Chapman** (DESY)  
**E. Gallo** (DESY)  
**C. Grojean** (DESY)  
**G. Grübel** (DESY)  
**B. Heinemann** (DESY)  
**Ç. İşsever** (DESY)  
**F. Kärtner** (DESY)  
**M. Kasemann** (DESY)  
**M. Kowalski** (DESY)  
**J. Küpper** (DESY)  
**M. Mönig** (DESY)  
**K. Peters** (DESY)  
**M. Pohl** (DESY)  
**R. Porto** (DESY)

**N. Rohringer** (DESY)  
**K. Rossnagel** (DESY)  
**R. Santra** (DESY)  
**M. Schnell-Küpper** (DESY)  
**V. Schomerus** (DESY)  
**C. Schroer** (DESY)  
**C. Schwabenberger** (DESY)  
**G. Servant** (DESY)  
**H. Sondermann** (DESY)  
**A. Stierle** (DESY)  
**K. Tackmann** (DESY)  
**S. Techert** (DESY)  
**G. Weiglein** (DESY)  
**H. Weise** (DESY)  
**H. Yan** (DESY)

Delegates from external partners  
**B. Atlay** (HU Berlin)  
**F. Ellinghaus** (KET)  
**S. Fiedler** (EMBL)  
**C. Gutt** (KAT)  
**J. Haller** (Univ. Hamburg)  
**D. Lott** (Hereon)  
**S. Molodtsov** (European XFEL)  
**N. N.** (KfB)  
**K. Sengstock** (Univ. Hamburg)  
**K. Valerius** (KAT)

**ACHIP Advisory Board**  
Reinhard Brinkmann

**ACHIP Executive Board**  
Ralph Aßmann

**ALBA Scientific Advisory Committee**  
Reinhard Brinkmann

**ALS-U Machine Advisory Committee**  
Winfried Decking

**APOLLON Laser Facility, Scientific Advisory Board**  
Wim Leemans

**APOLLON Laser Facility, Technical Advisory Committee**  
Ralph Aßmann

**APS DPB Executive Committee**  
Wim Leemans

**AREAL Project, Armenia, International Technical Advisory Committee**  
Klaus Flöttmann

**ARIES WP7 Rings with Ultra-Low Emittance**  
Riccardo Bartolini

**ARIES Sub-WP8.5 Advanced Instrumentation for FELs**  
Kay Wittenburg

**ARIES Workshop on Materials and Engineering Technologies for Particle Accelerator Beam Diagnostic Instruments, Scientific Programme Committee**  
Kay Wittenburg, Gero Kube

**Artificial Intelligence and Robotics for Accelerators (AIRA) Workshop, Organising Committee**  
Reinhard Bacher, Annika Eichler, Wim Leemans, Inga Pfeffer, Holger Schlarb

**BESSY Machine Advisory Committee**  
Winfried Decking

**BMBF Evaluation Committee "Physik der kleinsten Teilchen 2018–2021"**  
Ralph Aßmanns

**CAS Advisory Committee**  
Kay Wittenburg

**CAS Advanced Level (2021) Programme Committee**  
Kay Wittenburg

**CEA (CSTD)**  
Lutz Lilje

**CERN HL-LHC Cost and Schedule Review Committee**  
Winfried Decking

**CERN Scientific Policy Committee**  
Reinhard Brinkmann

**CHILFEL CAS–Helmholtz International Laboratory on FEL Science and Technology**  
Hans Weise (DESY Co-Spokesperson)

**Cockcroft Institute, Scientific Advisory Committee**  
Wim Leemans

**DPG-Nachwuchspreis für Beschleunigerphysik, Committee**  
Reinhard Brinkmann

**EAAC 2021 Organising Committee**  
Ralph Aßmann

**EIC Vacuum System Review**  
Lutz Lilje

**ELI Beamlines, International Scientific Advisory Committee**  
Wim Leemans

**ESO ELT Management Advisory Committee**  
Hans Weise

**ESRF Machine Advisory Committee**  
Riccardo Bartolini

**ESS Project Advisory Committee**  
Reinhard Brinkmann

**ESS Re-Baseline Committee**  
Hans Weise

**EuPRAXIA Collaboration Board**  
Wim Leemans, Jens Osterhoff

**EuPRAXIA ESFRI Consortium**  
Ralph Aßmann

**EuPRAXIA@SPARC\_LAB TDR Review Committee**  
Siegfried Schreiber

**European Network for Novel Accelerators (EuroNNAc)**  
Ralph Aßmann (Chair)

**EPS Accelerator Group**  
Ralph Aßmann (Chair)

**European Strategy for Particle Physics (ESPP) – Accelerator R&D Roadmap, European Laboratory Directors Group (LDG)**  
Wim Leemans

**ESPP – Accelerator R&D Roadmap, Expert Panel on High Gradient Acceleration – Plasmas and Lasers**  
Ralph Aßmann (Chair), Jens Osterhoff

**ESPP – Accelerator R&D Roadmap, Expert Panel on High Gradient RF Structures and Systems**  
Hans Weise

**ESPP – Accelerator R&D Roadmap, Subpanel on Energy-Recovery Linacs**  
Reinhard Brinkmann

**FACET-II Programme Advisory Committee**  
Andreas Maier

**FAIR Machine Advisory Committee**  
Kay Wittenburg

**FEL 2022 Scientific Programme Committee**  
Frank Stephan, Mathias Vogt



# Publications

**Fermilab Accelerator Advisory Committee**  
Hans Weise

**Future Circular Collider (FCC) International Advisory Committee**  
Ralph Aßmann

**Helmholtz ATHENAe**  
Jens Osterhoff

**Helmholtz Matter and Technologies – ARD**  
Jens Osterhoff

**Helmholtz International Labs, Mid-term Evaluation Committee**  
Ralph Aßmann

**Helmholtz Think Tank**  
Hans Weise

**High Energy Photon Source (HEPS) IHEP Beijing, Machine Advisory Committee**  
Riccardo Bartolini

**IBIC 2021–2022 International Programme Committee**  
Kay Wittenburg

**ICALEPCS International Scientific Advisory Committee**  
Reinhard Bacher

**ICFA Advanced and Novel Accelerators Panel, ALEGRO PWFA Working Group**  
Jens Osterhoff

**ICFA Beam Dynamics Panel**  
Rainer Wanzenberg

**I.FAST Work Package Technology Infrastructures**  
Hans Weise

**I.FAST Work Package Hight Brightness Accelerators for Light Sources**  
Riccardo Bartolini

**INFN Machine Advisory Committee**  
Riccardo Bartolini

**Innovationszentrum Forschungscampus Hamburg-Bahrenfeld GmbH, Beirat**  
Hans Weise

**International Committee on Ultra-Intense Lasers (ICUIL)**  
Andreas Maier

**IN2P3 Scientific Council**  
Ralph Aßmann

**IPAC 2021–2023 International Organising Committee and 2021 Programme Committee**  
Ralph Aßmann

**IVEC 2021 Technical Programme Committee**  
Stefan Choroba

**John Adams Institute, Advisory Board**  
Reinhard Brinkmann (Chair)

**LCLS Scientific Advisory Committee**  
Winfried Decking

**LCLS-II Commissioning Review**  
Winfried Decking, Siegfried Schreiber

**LCLS-II HE Facility Advisory Committee**  
Lutz Lilje

**LINAC 2022 International Organising Committee**  
Stefan Choroba, Hans Weise

**LINAC 2022 Scientific Programme Committee**  
Hans Weise

**NA-PAC 2022 Scientific Programme Committee**  
Wim Leemans

**NRC-ACOT Advisory Committee on TRIUMF**  
Hans Weise

**PCaPAC Programme Committee**  
Reinhard Bacher

**PIP-II Machine Advisory Committee**  
Hans Weise

**PITZ Collaboration Board**  
Siegfried Schreiber, Frank Stephan (Spokesperson)

**POHANG Accelerator Laboratory, International Advisory Committee**  
Winfried Decking

**PSI SLS-2.0 Machine Advisory Committee**  
Reinhard Brinkmann

**Siam Photon Source-II, Machine Advisory Committee**  
Riccardo Bartolini

**SNOWMASS 2021 Accelerator Frontier – Topical Group Advanced Accelerator Concepts**  
Ralph Aßmann

**SNOWMASS 2021 Accelerator Frontier – Topical Group Accelerator Technology R&D**  
Hans Weise

**SNOWMASS 2021 Implementation Task Force**  
Reinhard Brinkmann

**Superconducting Undulators (SCUs) for Advanced Light Sources Workshop, Organising Committee**  
Wim Leemans

**SuperKEKB Machine Advisory Committee**  
Ralph Aßmann

**Tesla Technology Collaboration (TTC)**  
Hans Weise (Chair)

**Tesla Technology Collaboration (TTC) Technical Board**  
Detlef Reschke (Chair)

**TIARA Governing Council**  
Ralph Aßmann, Wim Leemans

**UK/ESS High Beta Cavity Project Board**  
Detlef Reschke

## Publications

H. Abramowicz et al.  
**Conceptual Design Report for the LUXE Experiment.**  
*European physical journal special topics*, 230(11):2445, and PUBDB-2021-00893, arXiv:2102.02032. DESY-21-016.  
*doi: 10.1140/epjs/s11734-021-00249-z.*

F. Albert et al.  
**2020 Roadmap on Plasma Accelerators.**  
*New journal of physics*, 23(3):031101, and PUBDB-2021-04823.  
*doi: 10.1088/1367-2630/abcc62.*

S. Antipov et al.  
**Design of a Prototype Laser-Plasma Injector for an Electron Synchrotron.**  
*Physical review accelerators and beams*, 24(11):111301, and PUBDB-2021-02637, arXiv:2106.07367.  
*doi: 10.1103/PhysRevAccelBeams.24.111301.*

S. Antipov et al.  
**Proof-of-Principle Direct Measurement of Landau Damping Strength at the Large Hadron Collider with an Antidamper.**  
*Physical review letters*, 126(16):164801, and PUBDB-2022-00386, arXiv:2003.04383.  
*doi: 10.1103/PhysRevLett.126.164801.*

D. Bazyl et al.  
**CW Operation of the European XFEL: SC-Gun Injector Optimization, S2E Calculations and SASE Performance.**  
PUBDB-2021-03447, DESY-21-138. 4009371.  
arXiv:2111.01756.  
*doi: 10.3204/PUBDB-2021-03447.*

A. Bellandi et al.  
**Online Detuning Computation and Quench Detection for Superconducting Resonators.**  
*IEEE transactions on nuclear science*, 68(4):385, and PUBDB-2021-01832.  
*doi: 10.1109/TNS.2021.3067598.*

I. J. Bermudez Macias et al.  
**Study of temporal, spectral, arrival time and energy fluctuations of SASE FEL pulsesb.**  
*Optics express*, 29(7):10491, and PUBDB-2021-01418.  
*doi: 10.1364/OE.419977.*

S. Bettoni et al.  
**Experimental Demonstration of Two-Color X-Ray Free-Electron-Laser Pulses via Wakefield Excitation.**  
*Physical review accelerators and beams*, 24(8):082801, and PUBDB-2022-00264.  
*doi: 10.1103/PhysRevAccelBeams.24.082801.*

G. J. Boyle et al.  
**Reduced Model of Plasma Evolution in Hydrogen Discharge Capillary Plasmas.**  
*Physical review / E*, 104(1):015211, and PUBDB-2021-02866.  
*doi: 10.1103/PhysRevE.104.015211.*

R. Bruce et al.  
**Performance and Luminosity Models for Heavy-Ion Operation at the CERN Large Hadron Collider.**  
*The European physical journal / Plus*, 136(7):745, and PUBDB-2022-00582, arXiv:2107.09560.  
*doi: 10.1140/epjp/s13360-021-01685-5.*

A.-L. Calendron et al.  
**Bulk, cascaded pulse compression scheme and its application to spin emitter characterization.**  
*Applied optics*, 60(4):912, and PUBDB-2021-00703.  
*doi: 10.1364/AO.412177.*

Y. L. Chen et al.  
**Perspectives Towards Sub-Angstrom Working Regime of the European X-Ray Free-Electron Laser with Low-Emittance Electron Beams.**  
*Applied Sciences*, 11(22):10768, and PUBDB-2021-03158, DESY-21-139.  
*doi: 10.3390/app112210768.*

J. P. Couperus Cabadağ et al.  
**Gas-Dynamic Density Downramp Injection in a Beam-Driven Plasma Wakefield Accelerator.**  
*Physical review research*, 3(4):L042005, and PUBDB-2022-00579.  
*doi: 10.1103/PhysRevResearch.3.L042005.*

A. Dangwal Pandey et al.  
**Grain boundary segregation and carbide precipitation in heat treated niobium superconducting radio frequency cavities.**  
*Applied physics letters*, 119(19):194102, and PUBDB-2021-04744.  
*doi: 10.1063/5.0063379.*

M. Diez et al.  
**A Self-Referenced In-Situ Arrival Time Monitor for X-Ray Free-Electron Lasers.**  
*Scientific reports*, 11(1):3562, and PUBDB-2021-01766.  
*doi: 10.1038/s41598-021-82597-3.*

T. Ding et al.  
**Measuring the frequency chirp of extreme-ultraviolet free-electron laser pulses by transient absorption spectroscopy.**  
*Nature Communications*, 12(1):643 (1, and PUBDB-2021-00854.  
*doi: 10.1038/s41467-020-20846-1.*

C. Emma et al.  
**Free Electron Lasers driven by Plasma Accelerators: Status and Near-Term Prospects.**  
*High power laser science and engineering*, 9:e57 (1, and PUBDB-2021-05449.  
*doi: 10.1017/hpl.2021.39.*

R. Engel et al.  
**Shot noise limited soft X-ray absorption spectroscopy in solution at a SASE-FEL using a transmission grating beam splitter.**  
*Structural dynamics*, 8(1):014303 (1, and PUBDB-2021-00319.  
*doi: 10.1063/4.0000049.*



- K. Floettmann.  
**Coherent Superposition of Orthogonal Hermite-Gauss Modes.**  
*Optics communications*, 505:127537, and PUBDB-2021-02534.  
doi: 10.1016/j.optcom.2021.127537.
- K. Floettmann.  
**Superradiant Cherenkov-Wakefield Radiation as THz Source for FEL Facilities.**  
*Journal of synchrotron radiation*, 28(1):18, and PUBDB-2020-04659.  
doi: 10.1107/S1600577520014058.
- J. M. Garland et al.  
**Combining Laser Interferometry and Plasma Spectroscopy for Spatially Resolved High-Sensitivity Plasma Density Measurements in Discharge Capillaries.**  
*Review of scientific instruments*, 92(1):013505, and PUBDB-2021-05455.  
doi: 10.1063/5.0021117.
- G. Geloni et al.  
**Frequency-Mixing Lasing Mode at European XFEL.**  
*Applied Sciences*, 11(18):8495, and PUBDB-2022-00773.  
doi: 10.3390/app11188495.
- P. Grychtol et al.  
**Timing and X-ray pulse characterization at the Small Quantum Systems instrument of the European X-ray Free Electron Laser.**  
*Optics express*, 29(23):37429, and PUBDB-2021-04250.  
doi: 10.1364/OE.440718.
- S. Jalas et al.  
**Bayesian Optimization of a Laser-Plasma Accelerator.**  
*Physical review letters*, 126(10):104801, and PUBDB-2021-00902.  
doi: 10.1103/PhysRevLett.126.104801.
- M. Kellermeier et al.  
**Self-Calibration Technique for Characterization of Integrated THz Waveguides.**  
*Physical review accelerators and beams*, 24(12):122001, and PUBDB-2021-01639, arXiv:2104.01401.  
doi: 10.1103/PhysRevAccelBeams.24.122001.
- B. Kettle et al.  
**A laser-plasma platform for photon-photon physics: the two photon Breit-Wheeler process.**  
*New journal of physics*, 23(11):115006, and PUBDB-2021-02828.  
doi: 10.1088/1367-2630/ac3048.
- M. Kirchen et al.  
**Optimal Beam Loading in a Laser-Plasma Accelerator.**  
*Physical review letters*, 126:174801, and PUBDB-2021-01303.  
doi: 10.1103/PhysRevLett.126.174801.
- A. Knetsch et al.  
**Stable witness-beam formation in a beam-driven plasma cathode.**  
*Physical review accelerators and beams*, 24(10):101302, and PUBDB-2021-02678, arXiv:2007.12639. DESY-20-125.  
doi: 10.1103/PhysRevAccelBeams.24.101302.
- T. Kurz et al.  
**Demonstration of a Compact Plasma Accelerator powered by Laser-Accelerated Electron Beams.**  
*Nature Communications*, 12(1):2895, and PUBDB-2022-00432, arXiv:1909.06676.  
doi: 10.1038/s41467-021-23000-7.
- C. A. Lindstroem et al.  
**Energy-spread preservation and high efficiency in a plasma-wakefield accelerator.**  
*Physical review letters*, 126(1):014801 (1, and PUBDB-2020-04955.  
doi: 10.1103/PhysRevLett.126.014801.
- C. Mahnke et al.  
**Long term stable, synchronizable, low noise picosecond Ho: fiber NALM oscillator for Ho: YLF amplifier seeding.**  
*Optics letters*, 47(4):822, and PUBDB-2021-04091.  
doi: 10.1364/OL.447353.
- B. Marchetti et al.  
**Experimental Demonstration of Novel Beam Characterization using a Polarizable X-Band Transverse Deflection Structure.**  
*Scientific reports*, 11(1):3560, and PUBDB-2021-00947.  
doi: 10.1038/s41598-021-82687-2.
- M. Martyanov et al.  
**Induced Modulation of a Chirped Laser Pulse at Terahertz Frequency with Spectral Phase Shaping.**  
*Journal of the Optical Society of America / B*, 38(10):3179, and PUBDB-2021-05247.  
doi: 10.1364/JOSAB.436224.
- A. Mielczarek et al.  
**Real-Time Data Acquisition and Processing System for MHz Repetition Rate Image Sensors.**  
*Energies*, 14(21):7403, and PUBDB-2021-05434.  
doi: 10.3390/en14217403.
- N. Mirian et al.  
**Characterization of Soft X-ray Echo-Enabled Harmonic Generation Free-Electron Laser Pulses in the Presence of Incoherent Electron Beam Energy Modulations.**  
*Physical review accelerators and beams*, 24(8):080702, and PUBDB-2021-02519, DESY-21-090. arXiv:2106.04161.  
doi: 10.1103/PhysRevAccelBeams.24.080702.
- N. Mirian et al.  
**Generation and Measurement of Intense Few-Femtosecond Superradiant Extreme-Ultraviolet Free-Electron Laser Pulses.**  
*Nature photonics*, 15(1109):523, and PUBDB-2021-02596.  
doi: 10.1038/s41566-021-00815-w.
- N. Mirian et al.  
**High-Repetition Rate and Coherent Free-Electron Laser in the Tender X Rays based on the Echo-Enabled Harmonic Generation of an Ultraviolet Oscillator Pulse.**  
*Physical review accelerators and beams*, 24(5):050702, and PUBDB-2021-02595.  
doi: 10.1103/PhysRevAccelBeams.24.050702.
- A. Myers et al.  
**Porting WarpX to GPU-Accelerated Platforms.**  
*Parallel computing*, 108:102833, and PUBDB-2022-00533, arXiv:2101.12149.  
doi: 10.1016/j.parco.2021.102833.
- A. Nawaz et al.  
**Probabilistic Model-Based Fault Diagnosis for the Cavities of the European XFEL.**  
*Automatisierungstechnik*, 69(6):538, and PUBDB-2022-00523.  
doi: 10.1515/auto-2020-0064.
- R. M. Nazhmudinov et al.  
**K-Shell Ionization Cross Section of Ti and Cu Atoms by 1 and 2 GeV Electrons.**  
*Journal of physics / B*, 54(4):045201 (1, and PUBDB-2021-02984.  
doi: 10.1088/1361-6455/abd961.
- Z. Nergiz et al.  
**Bright Angstrom and Picometre Free Electron Laser Based on the LHeC Energy Recovery Linac.**  
*Physical review accelerators and beams*, 24:100701, and PUBDB-2021-03491, arXiv:2107.13331.  
doi: 10.1103/PhysRevAccelBeams.24.100701.
- G. Paraskaki et al.  
**Advanced Scheme to Generate MHz, Fully Coherent FEL Pulses at nm Wavelength.**  
*Applied Sciences*, 11(13):6058, and PUBDB-2022-00663.  
doi: 10.3390/app11136058.
- G. Paraskaki et al.  
**High repetition rate seeded FEL with an optical klystron in high-gain harmonic generation.**  
*Physical review accelerators and beams*, 24(12):120701 (1, and PUBDB-2021-03411.  
doi: 10.1103/PhysRevAccelBeams.24.120701.
- G. Paraskaki et al.  
**Optimization and stability of a high-gain harmonic generation seeded oscillator amplifier.**  
*Physical review accelerators and beams*, 24(3):034801, and PUBDB-2022-00341.  
doi: 10.1103/PhysRevAccelBeams.24.034801.
- A. Potylitsyn et al.  
**First Observation of Quasi-Monochromatic Optical Cherenkov Radiation in a Dispersive Medium (Quartz).**  
*Physics letters / A*, 417:127680, and PUBDB-2021-01540.  
doi: 10.1016/j.physleta.2021.127680.
- D. Ratner et al.  
**Recovering the Phase and Amplitude of X-Ray FEL Pulses using Neural Networks and Differentiable Models.**  
*Optics express*, 29(13):20336, and PUBDB-2021-03417.  
doi: 10.1364/OE.432488.
- D. Rohrbach et al.  
**THz-Driven Split Ring Resonator Undulator.**  
*Physical review accelerators and beams*, 24(1):010703, and PUBDB-2021-05151.  
doi: 10.1103/PhysRevAccelBeams.24.010703.
- L. Schaper et al.  
**Flexible and Coherent Soft X-ray Pulses at High Repetition Rate.**  
*Applied Sciences*, 11(20):9729, and PUBDB-2021-03805.  
doi: 10.3390/app11209729.
- B. E. J. Scheible et al.  
**Pickup Development for Short Low-Charge Bunches in X-Ray Free-Electron Lasers.**  
*Physical review accelerators and beams*, 24(7):072803, and PUBDB-2021-03616.  
doi: 10.1103/PhysRevAccelBeams.24.072803.
- A. Seidel, J. Osterhoff and M. Zepf.  
**Characterizing Ultralow Emittance Electron Beams using Structured Light Fields.**  
*Physical review accelerators and beams*, 24(1):012803, and PUBDB-2021-05456, arXiv:2008.01703.  
doi: 10.1103/PhysRevAccelBeams.24.012803.
- G. Shu et al.  
**Dark Current Studies of an L-band Normal Conducting RF Gun.**  
*Nuclear instruments & methods in physics research / A*, 1010:165546, and PUBDB-2021-02821.  
doi: 10.1016/j.nima.2021.165546.
- G. Shu et al.  
**Experimental benchmark study of multiphysics simulations of an L-band high average power RF gun.**  
*Nuclear instruments & methods in physics research / A*, 1004:165344 (1, and PUBDB-2021-02290.  
doi: 10.1016/j.nima.2021.165344.
- K. N. Sjobak et al.  
**Strong focusing gradient in a linear active plasma lens.**  
*Physical review accelerators and beams*, 24(12):121306, and PUBDB-2021-03811, arXiv:2012.10680.  
doi: 10.1103/PhysRevAccelBeams.24.121306.
- Y. R. Sturz, A. Eichler and R. S. Smith.  
**Distributed Control Design for Heterogeneous Interconnected Systems.**  
*IEEE transactions on automatic control*, 66(11):5112, and PUBDB-2022-00485.  
doi: 10.1109/TAC.2020.3034202.
- K. K. Swanson et al.  
**Cryogenically Formed Discharge Waveguide.**  
*Physical review accelerators and beams*, 24(9):091301, and PUBDB-2021-04824.  
doi: 10.1103/PhysRevAccelBeams.24.091301.
- J. H. K. Timm et al.  
**The Trip Event Logger for Online Fault Diagnosis at the European XFEL.**  
12th International Particle Accelerator Conference, Campinas (Brazil), 24 May 2021 - 28 May 2021.  
2673-5490,3344, and PUBDB-2021-05177.  
JACoW Publishing, Switzerland, Geneva.  
doi: 10.18429/JACoW-IPAC2021-WEPA293.



S. Tomin et al.  
**Accurate Measurement of Uncorrelated Energy Spread in Electron Beam.**

*Physical review accelerators and beams*, 24(6):064201, and PUBDB-2021-05268.  
*doi: 10.1103/PhysRevAccelBeams.24.064201.*

D. Ullmann et al.  
**All-Optical Density Downramp Injection in Electron-Driven Plasma Wakefield Accelerators.**

*Physical review research*, 3(4):043163, and PUBDB-2022-00250.  
*doi: 10.1103/PhysRevResearch.3.043163.*

J.-L. Vay et al.  
**Modeling of a Chain of Three Plasma Accelerator Stages with the WarpX Electromagnetic PIC Code on GPUs.**

*Physics of plasmas*, 28(2):023105, and PUBDB-2022-00289.  
*doi: 10.1063/5.0028512.*

J. Wei et al.  
**Cavity Tilt Measurement using Beam Excited Higher Order Mode Signals at the Free Electron Laser FLASH.**

*Nuclear instruments & methods in physics research / A*, 1000:165246, and PUBDB-2022-00216.  
*doi: 10.1016/j.nima.2021.165246.*

M. Wieland et al.  
**Deriving x-ray pulse duration from center-of-energy shifts in THz-streaked ionized electron spectra.**

*Optics express*, 29(21):32739, and PUBDB-2021-05635.  
*doi: 10.1364/OE.432761.*

S. Yamin et al.  
**Final Focus System for Injection into a Laser Plasma Accelerator.**

*Physical review accelerators and beams*, 24(9):091602, and PUBDB-2021-05699.  
*doi: 10.1103/PhysRevAccelBeams.24.091602.*

I. Zagorodnov and M. Dohlus.  
**Axial Representation of External Time-Dependent Electromagnetic Fields for Particle Tracking in Accelerators.**

*Nuclear instruments & methods in physics research / A*, 1009:165482 (1, and PUBDB-2021-02643, arXiv:1909.03438. DESY-19-192.  
*doi: 10.1016/j.nima.2021.165482.*

I. Zagorodnov et al.  
**Experimental Validation of Collective Effects Modeling at Injector Section of X-Ray Free-Electron Laser.**

*Nuclear instruments & methods in physics research / A*, 995:165111, and PUBDB-2021-05267, arXiv:2010.10204.  
*doi: 10.1016/j.nima.2021.165111.*

S. Zhao et al.  
**Longitudinal Phase Space Improvement of a Continuous-Wave Photoinjector Toward X-ray Free-Electron Laser Application.**

*Nuclear instruments & methods in physics research / A*, 1018:165796, and PUBDB-2022-00243.  
*doi: 10.1016/j.nima.2021.165796.*

J. Zhu et al.  
**High-fidelity Prediction of Megapixel Longitudinal Phase-Space Images of Electron Beams Using Encoder-Decoder Neural Networks.**

*Physical review applied*, 16(2):024005, and PUBDB-2021-02299, arXiv:2101.10437.  
*doi: 10.1103/PhysRevApplied.16.024005.*

X.-L. Zhu et al.  
**Generation of 100-MeV Attosecond Electron Bunches with Terawatt Few-Cycle Laser Pulses.**

*Physical review applied*, 15(4):044039, and PUBDB-2022-00583.  
*doi: 10.1103/PhysRevApplied.15.044039.*

A. Zingale et al.  
**Emittance Preserving Thin Film Plasma Mirrors for GeV Scale Laser Plasma Accelerators.**

*Physical review accelerators and beams*, 24(12):121301, and PUBDB-2021-05387.  
*doi: 10.1103/PhysRevAccelBeams.24.121301.*

## Preprints and Internal Reports

S. Lal et al.  
**Design Studies of a Continuous-Wave Normal Conducting Buncher for European XFEL.**

PUBDB-2021-05027.  
*doi: 10.3204/PUBDB-2021-05027.*

E. Panofski et al.  
**Commissioning Results and Electron Beam Characterization at the S-band Photoinjector at SINBAD-ARES.**

PUBDB-2021-02826, DESY-21-108. arXiv:2106.14867.  
*doi: 10.3204/PUBDB-2021-02826.*

A. Potter et al.  
**Heat Load on the European XFEL Collimators from Beam Particles Scattered by a Slotted Foil.**

PUBDB-2021-05595, DESY-M-21-01.  
*doi: 10.3204/PUBDB-2021-05595.*

E. A. Schneidmiller et al.  
**Observation of Harmonic Lasing in the Angstrom Regime at European X-Ray Free Electron Laser.**

*Physical review accelerators and beams*, 24(3):030701 (1, and PUBDB-2021-01638, 21-036. arXiv:2104.00384. DESY-21-036.  
*doi: 10.1103/PhysRevAccelBeams.24.030701.*

M. Zeng, A. Martinez de la Ossa and J. Osterhoff.  
**Ponderomotively Assisted Ionization Injection in Plasma Wakefield Accelerators.**

PUBDB-2021-02367, arXiv:2008.08485. DESY-20-138.  
*doi: 10.3204/PUBDB-2021-02367.*

## Conference Contributions

### IBIC 2021

C. Gerth and N. M. Lockmann.  
**Bunch Compression Monitor Based on Coherent Diffraction Radiation at European XFEL and FLASH.**

10th International Beam Instrumentation Conference, Virtual Conference (South Korea), 13 Sep 2021 - 17 Sep 2021. PUBDB-2021-04886.  
*doi: 10.18429/JACOW-IBIC2021-WEPP14.*

G. Kube et al.  
**Tests of the New BPM Long Term Drift Stabilization Scheme Based on External Crossbar Switching at PETRA III.**

10th International Beam Instrumentation Conference, Pohang (South Korea), 13 Sep 2021 - 17 Sep 2021. PUBDB-2021-03633.  
*doi: 10.18429/JACOW-IBIC2021-MOPP30.*

D. Lipka.  
**Design of a Cavity Beam Position Monitor for the FLASH 2020+ Undulator Intersection Project at DESY.**

10th International Beam Instrumentation Conference, Seoul (South Korea), 13 Sep 2021 - 17 Sep 2021. PUBDB-2021-03379.  
*doi: 10.18429/JACoW-IBIC2021-MOPP08.*

B. Scheible et al.  
**Bunch Arrival-Time Measurement with Rod-Shaped Pickups on a Printed Circuit Board for X-Ray Free-Electron Lasers.**

10th International Beam Instrumentation Conference, Pohang (Korea), 13 Sep 2021 - 17 Sep 2021. PUBDB-2021-05487.  
JACoW Publishing, Geneva, Switzerland.

*doi: 10.18429/JACOW-IBIC2021-WEPP19.*

### 10th MicroTCA Workshop for Industry and Research

M. Fenner et al.  
**Latest Hardware Developments in MicroTCA.4.**

10th MicroTCA Workshop for Industry and Research, Hamburg (Germany), 7 Dec 2021 - 9 Dec 2021. PUBDB-2022-00048.

M. Fenner et al.  
**RF Performance of Zone 3 class RF1.0 on a Reference RTM Design.**

10th MicroTCA Workshop for Industry and Research, Hamburg (Germany), 7 Dec 2021 - 9 Dec 2021. PUBDB-2022-00044.

O. Gerberding et al.  
**Update on LISA Phasemeter Based on MicroTCA as Ground-Support Equipment.**

10th MicroTCA Workshop for Industry and Research, Hamburg (Germany), 7 Dec 2021 - 9 Dec 2021. PUBDB-2022-00043.

P. Huesmann.  
**Overview of MMC Stamp Software Development Kit.**

10th MicroTCA Workshop for Industry and Research, Hamburg (Germany), 7 Dec 2021 - 9 Dec 2021. PUBDB-2022-00051.

M. Killenberg et al.  
**Improvements in ChimeraTK DeviceAccess.**

10th MicroTCA Workshop for Industry and Research, Hamburg (Germany), 7 Dec 2021 - 9 Dec 2021. PUBDB-2022-00050.

H. Lippek.  
**X3Timer – Design and Development of a New Timing AMC Hardware for PETRA IV.**

10th MicroTCA Workshop for Industry and Research, Hamburg (Germany), 7 Dec 2021 - 9 Dec 2021. PUBDB-2022-00047.

U. Mavric et al.  
**Current Status and Future Plans for the DeRTM LO and CLK Generation Module.**

10th MicroTCA Workshop for Industry and Research, Hamburg (Germany), 7 Dec 2021 - 9 Dec 2021. PUBDB-2022-00046.

### IPAC21

E. Allaria et al.  
**FLASH2020+ Plans for a New Coherent Source at DESY.**

12th International Particle Accelerator Conference, Campinas (Brazil), 24 May 2021 - 28 May 2021. PUBDB-2021-05169.  
JACoW Publishing, Geneva, Switzerland.

*doi: 10.18429/JACOW-IPAC2021-TUPAB086.*

P. Amstutz and M. Vogt.  
**Investigation of Vlasov Systems with a Certain Class of Linearly-Collective Hamiltonians.**

12th International Particle Accelerator Conference, Campinas (Brazil), 24 May 2021 - 28 May 2021. PUBDB-2021-05597.  
JACoW Publishing, Geneva, Switzerland.

*doi: 10.18429/JACoW-IPAC2021-WEPA226.*

F. Brinker, S. Casalbuoni and W. Freund.  
**Correcting the Magnetic Field Offsets Inside the Undulators of the EuXFEL Using the K-Monochromator.**

12th International Particle Accelerator Conference, Campinas (Brazil), 24 May 2021 - 28 May 2021. PUBDB-2021-05192.  
*doi: 10.18429/JACoW-IPAC2021-THPAB080.*

S. Casalbuoni et al.  
**Towards a Superconducting Undulator Afterburner for the European XFEL.**

12th International Particle Accelerator Conference, Campinas (Brazil), 24 May 2021 - 28 May 2021. PUBDB-2021-05004.  
*doi: 10.18429/JACOW-IPAC2021-WEPA132.*



- F. Christie et al.  
**Redesign of the FLASH2 Post-SASE Undulator Beamline.**  
12th International Particle Accelerator Conference, Campinas (Brazil), 24 May 2021 - 28 May 2021.  
PUBDB-2021-05632.  
JACoW Publishing, Geneva, Switzerland, [Geneva].  
*doi: 10.18429/JACOW-IPAC2021-TUPAB104.*
- M. K. Czwalińska et al.  
**Beam Arrival Stability at the European XFEL.**  
12th International Particle Accelerator Conference, Campinas (Brazil), 24 May 2021 - 28 May 2021.  
PUBDB-2021-04889.  
JACoW Publishing, Geneva, Switzerland.  
*doi: 10.18429/JACOW-IPAC2021-THXB02.*
- H. Dinter et al.  
**Status of the Dedicated Electron Diagnostic Beamline at AXISIS.**  
12th International Particle Accelerator Conference, Campinas (Brazil), 24 May 2021 - 28 May 2021.  
PUBDB-2021-03642.  
JACoW, Geneva.  
*doi: 10.18429/JACOW-IPAC2021-MOPAB284.*
- A. Eichler et al.  
**First Steps Toward an Autonomous Accelerator, a Common Project Between DESY and KIT.**  
12th International Particle Accelerator Conference, Campinas (Brazil), 24 May 2021 - 28 May 2021.  
PUBDB-2021-05353.  
JACoW Publishing, Geneva, Switzerland.  
*doi: 10.18429/JACOW-IPAC2021-TUPAB298.*
- C. Gerth et al.  
**Layout of the Laser Heater for FLASH2020+.**  
12th International Particle Accelerator Conference, Campinas (Brazil), 24 May 2021 - 28 May 2021.  
PUBDB-2021-05415.  
JACoW Publishing, Geneva, Switzerland.  
*doi: 10.18429/JACoW-IPAC2021-TUPAB111.*
- M. Groß et al.  
**Characterization of Low Emittance Electron Beams Generated by Transverse Laser Beam Shaping.**  
12th International Particle Accelerator Conference, Campinas (Brazil), 24 May 2021 - 28 May 2021.  
PUBDB-2021-05218.  
*doi: 10.18429/JACoW-IPAC2021-WEPAB040.*
- J.-J. Guo et al.  
**Beam Loss Study for the Implementation of Dechirper at the European XFEL.**  
12th International Particle Accelerator Conference, Campinas (Brazil), 24 May 2021 - 28 May 2021.  
PUBDB-2021-04999.  
JACoW Publishing, Geneva, Switzerland.  
*doi: 10.18429/JACOW-IPAC2021-TUPAB119.*
- A. Ivanov et al.  
**Physics-Enhanced Reinforcement Learning for Optimal Control.**  
12th International Particle Accelerator Conference, Campinas (Brazil), 24 May 2021 - 28 May 2021.  
PUBDB-2021-05369.  
*doi: 10.18429/JACOW-IPAC2021-THPAB191.*
- M. I. Ivanyan et al.  
**Transverse Impedance of Lossy Circular Metal-Dielectric Waveguides.**  
12th International Particle Accelerator Conference, Campinas (Brazil), 24 May 2021 - 28 May 2021.  
PUBDB-2021-02182.
- S. M. Jaster-Merz et al.  
**Characterization of the Full Transverse Phase Space of Electron Bunches at ARES.**  
12th International Particle Accelerator Conference, Campinas (Brazil), 24 May 2021 - 28 May 2021.  
PUBDB-2021-04871.  
JACoW Publishing, Geneva.  
*doi: 10.18429/JACoW-IPAC2021-MOPAB302.*
- S. Karabekyan et al.  
**SASE3 Variable Polarization Project at the European XFEL.**  
12th International Particle Accelerator Conference, Campinas (Brazil), 24 May 2021 - 28 May 2021.  
PUBDB-2021-05193.  
*doi: 10.18429/JACOW-IPAC2021-TUPAB122.*
- J. Keil, I. Agapov and R. Brinkmann.  
**A Lattice for PETRA IV Based on the Combination of Different Arc Cell Designs.**  
12th International Particle Accelerator Conference, Campinas (Brazil), 24 May 2021 - 28 May 2021.  
PUBDB-2021-04867.  
JACoW Publishing, Geneva.  
*doi: 10.18429/JACoW-IPAC2021-MOPAB109.*
- B. Koubek et al.  
**LILac Energy Upgrade to 13 MeV.**  
12th International Particle Accelerator Conference, Campinas (Brazil), 24 May 2021 - 28 May 2021.  
PUBDB-2021-04892.  
JACoW Publishing, Geneva, Switzerland.  
*doi: 10.18429/JACOW-IPAC2021-MOPAB192.*
- M. Krasilnikov et al.  
**Modeling the Magnetic Field of the LCLS-I Undulator for THz@PITZ.**  
12th International Particle Accelerator Conference, Campinas (Brazil), 24 May 2021 - 28 May 2021.  
PUBDB-2021-05215.  
*doi: 10.18429/JACoW-IPAC2021-THPAB049.*
- B. Lautenschlager et al.  
**Arrival Time Stabilization at Flash Using the Bunch Arrival Corrector Cavity (BACCA).**  
12th International Particle Accelerator Conference, Campinas (Brazil), 24 May 2021 - 28 May 2021.  
PUBDB-2021-04891.  
JACoW Publishing, Geneva, Switzerland.  
*doi: 10.18429/JACOW-IPAC2021-TUPAB302.*
- X. Li et al.  
**Matching of a Space-Charge Dominated Beam into the Undulator of the THz SASE FEL at PITZ.**  
12th International Particle Accelerator Conference, Campinas (Brazil), 24 May 2021 - 28 May 2021.  
PUBDB-2021-05216.  
*doi: 10.18429/JACOW-IPAC2021-WEPAB257.*
- H. Lippek et al.  
**A New Timing System for PETRA IV.**  
12th International Particle Accelerator Conference, Campinas (Brazil), 24 May 2021 - 28 May 2021.  
PUBDB-2021-02177.  
JACoW Publishing, Geneva, Switzerland.  
*doi: 10.18429/JACOW-IPAC2021-WEPAB288.*
- A. Lueangaramwong et al.  
**Numerical Study of Beam Dynamics in PITZ Bunch Compressor.**  
12th International Particle Accelerator Conference, Campinas (Brazil), 24 May 2021 - 28 May 2021.  
PUBDB-2021-05035.  
*doi: 10.18429/JACoW-IPAC2021-WEPAB274.*
- C. Mahnke et al.  
**Near-Infrared Laser System for Dielectric Laser Acceleration Experiments at SINBAD.**  
12th International Particle Accelerator Conference, Campinas (Brazil), 24 Oct 2021 - 28 Oct 2021.  
PUBDB-2021-04080.  
JACoW Publishing, Geneva, Switzerland.  
*doi: 10.18429/JACOW-IPAC2021-WEPAB378.*
- S. Mohanty et al.  
**Development of Multi-Alkali Antimonides Photocathodes for High-Brightness RF Photoinjectors.**  
12th International Particle Accelerator Conference, Campinas (Brazil), 24 May 2021 - 28 May 2021.  
PUBDB-2021-05217.  
*doi: 10.18429/JACoW-IPAC2021-TUPAB034.*
- L. Nevay et al.  
**Recent BDSIM Related Developments and Modeling of Accelerators.**  
12th International Particle Accelerator Conference, Campinas (Brazil), 24 May 2021 - 28 May 2021.  
PUBDB-2021-05003.  
JACoW Publishing, Geneva, Switzerland.  
*doi: 10.18429/JACOW-IPAC2021-THPAB214.*
- P. Nonn et al.  
**Providing Computing Power for High Level Controllers in MicroTCA-based LLRF Systems via PCI Express Extension.**  
12th International Particle Accelerator Conference, Campinas (Brazil), 24 May 2021 - 28 May 2021.  
PUBDB-2021-05359.  
*doi: 10.18429/JACOW-IPAC2021-THPAB287.*
- F. Pannek et al.  
**Mitigation of Beam Instabilities in the Echo-Enabled Harmonic Generation Beamline for FLASH2020+.**  
12th International Particle Accelerator Conference, Campinas (Brazil), 24 May 2021 - 28 May 2021.  
PUBDB-2021-05599.  
JACoW Publishing, Geneva, Switzerland, [Geneva].  
*doi: 10.18429/JACOW-IPAC2021-FRXA06.*
- E. Panofski et al.  
**Developing a 50 MeV LPA-Based Injector at ATHENA for a Compact Storage Ring.**  
12th International Particle Accelerator Conference, Campinas (Brazil), 24 May 2021 - 28 May 2021.  
PUBDB-2021-05187.  
JACoW Publishing, Geneva, Switzerland.  
*doi: 10.18429/JACOW-IPAC2021-TUPAB163.*
- S. Pfeiffer et al.  
**LLRF Control and Synchronization System of the ARES Facility.**  
12th International Particle Accelerator Conference, Campinas (Brazil), 24 May 2021 - 28 May 2021.  
PUBDB-2021-04761.  
*doi: 10.18429/JACOW-IPAC2021-WEPAB294.*
- S. Pfeiffer et al.  
**Parameter Estimation of Short Pulse Normal-Conducting Standing Wave Cavities.**  
12th International Particle Accelerator Conference, Campinas (Brazil), 24 May 2021 - 28 May 2021.  
PUBDB-2021-04762.  
*doi: 10.18429/JACoW-IPAC2021-WEPAB295.*
- A. Potter et al.  
**Studies of Particle Losses From the Beam in the EU-XFEL Following Scattering by a Slotted Foil.**  
12th International Particle Accelerator Conference, Campinas (Brazil), 24 May 2021 - 28 May 2021.  
PUBDB-2021-05002.  
*doi: 10.18429/JACOW-IPAC2021-TUPAB125.*
- J. Rönisch-Schulenburg et al.  
**Status Report of the Superconducting Free-Electron Laser FLASH at DESY.**  
12th International Particle Accelerator Conference, Campinas (Brazil), 24 May 2021 - 28 May 2021.  
PUBDB-2021-05633.  
JACoW Publishing, Geneva, Switzerland.  
*doi: 10.18429/JACOW-IPAC2021-TUPAB115.*
- M. Schütte et al.  
**Subsystem Level Data Acquisition for the Optical Synchronization System at European XFEL.**  
12th International Particle Accelerator Conference, Campinas (Brazil), 24 May 2021 - 28 May 2021.  
PUBDB-2021-04890.  
*doi: 10.18429/JACOW-IPAC2021-TUPAB291.*
- R. Stark et al.  
**Demonstration of a Novel Longitudinal Phase Space Linearization Method without Higher Harmonics.**  
12th International Particle Accelerator Conference, Campinas (Brazil), 24 May 2021 - 28 May 2021.  
PUBDB-2021-02193.



E. Syresin et al.  
**SASE Gain-Curve Measurements with MCP-Based Detectors at the European XFEL.**  
12th International Particle Accelerator Conference, Campinas (Brazil), 24 May 2021 - 28 May 2021.  
PUBDB-2021-05702.  
JACoW Publishing, Geneva.  
*doi: 10.18429/JACoW-IPAC2021-MOPAB018.*

M. Vogt and J. Zemella.  
**A New 2nd Bunch Compression Chicane for the FLASH2020+ Project.**  
12th International Particle Accelerator Conference, Campinas (Brazil), 24 May 2021 - 28 May 2021.  
PUBDB-2021-05660.  
JACoW Publishing, Geneva, Switzerland.  
*doi: 10.18429/JACoW-IPAC2021-TUPAB102.*

T. Weilbach et al.  
**Beam Line Design and Instrumentation for THz@PITZ - the Proof-of-Principle Experiment on a THz SASE FEL at the PITZ Facility.**  
12th International Particle Accelerator Conference, Campinas (Brazil), 24 May 2021 - 28 May 2021.  
PUBDB-2021-05237.  
JACoW Publishing, Geneva, Switzerland.  
*doi: 10.18429/JACoW-IPAC2021-TUPAB071.*

C. Xu et al.  
**Machine Learning Based Spatial Light Modulator Control for the Photoinjector Laser at FLUTE.**  
12th International Particle Accelerator Conference, Campinas (Brazil), 24 May 2021 - 28 May 2021.  
PUBDB-2021-05360.  
JACoW Publishing, Geneva, Switzerland.  
*doi: 10.18429/JACoW-IPAC2021-WEPAB289.*

#### Other Conference Contributions

E. Allaria et al.  
**FLASH2020+: The New High Repetition Rate Coherent Soft X-Ray Facility.**  
CLEO: *QELS<sub>F</sub>undamental* Science, San Jose (California), 9 May 2021 - 14 May 2021.  
PUBDB-2022-00019.  
OSA Washington, D.C.  
*doi: 10.1364/CLEO\_QELS.2021.FTu2O.5.*

R. Bacher et al.  
**Towards a New Control System for PETRA IV.**  
18th International Conference on Accelerator and Large Experimental Physics Control Systems, Shanghai (Peoples R China), 18 Oct 2021 - 22 Oct 2021.  
PUBDB-2021-03925.

J. Branlard et al.  
**Four Years of Successful Operation of The European XFEL.**  
2021 International Conference on RF Superconductivity, Michigan (USA), 28 Jun 2021 - 2 Jul 2021.  
PUBDB-2021-04885.

E. Escoto et al.  
**Temporal pulse quality in cascaded post-compression.**  
The European Optical Society Annual Meeting, EOSAM, Rome (Italy), 13 Sep 2021 - 16 Sep 2021.  
PUBDB-2022-00600.

B. List et al.  
**CAD Integration for PETRA-IV.**  
11th International Conference on Mechanical Engineering Design of Synchrotron Radiation Equipment and Instrumentation, Chicago, IL (USA), 26 Jul 2021 - 29 Jul 2021.  
PUBDB-2021-05077.  
*doi: 10.18429/JACoW-MEDSI2020-WEOA01.*

G. Martino et al.  
**Comparative Evaluation of Semi-Supervised Anomaly Detection Algorithms on High-Integrity Digital Systems.**  
24th Euromicro Conference on Digital System Design (DSD), Palermo (Italy), 1 Sep 2021 - 3 Sep 2021.  
PUBDB-2021-04884.  
*doi: 10.1109/DSD53832.2021.00028.*

S. Rajhans et al.  
**Post-Compression of 8.6 mJ ps-Pulses from an Yb:YAG In-slab Amplifier using a Compact Multi-pass Cell.**  
Advanced Solid State Lasers, Washington D.C. (USA), 3 Oct 2021 - 7 Oct 2021.  
PUBDB-2022-00685.  
Optica Publishing Group.  
*doi: 10.1364/ASSL.2021.AW2A.6.*

W. H. Syed et al.  
**Koopman-based Kalman Filter for Fault Detection for the Superconducting Radio Frequency Cavities of the European XFEL.**  
60th Conference on Decision and Control, Austin, Texas (USA), 13 Dec 2021 - 15 Dec 2021.  
PUBDB-2021-03762.

## Conference Presentations

### IBIC2021

P. Forck et al.  
**Summary of the ARIES Workshop on Materials and Engineering Technologies for Particle Accelerator Beam Diagnostic Instruments.**  
10th International Beam Instrumentation Conference, Pohang (South Korea), 13 Sep 2021 - 17 Sep 2021.  
PUBDB-2021-04224.

G. Kube et al.  
**Tests of the New BPM Long Term Drift Stabilization Scheme Based on External Crossbar Switching at PETRA III.**  
10th International Beam Instrumentation Conference, Pohang (South Korea), 13 Sep 2021 - 17 Sep 2021.  
PUBDB-2021-04223.

D. Lipka.  
**Design of a Cavity Beam Position Monitor for the FLASH 2020+ Undulator Intersection Project at DESY.**  
10th International Beam Instrumentation Conference, Pohang (South Korea), 13 Sep 2021 - 17 Sep 2021.  
PUBDB-2021-04226.

F. Schmidt-Föhre, G. Kube and K. Wittenburg.  
**Comparison of Two Long Term Drift Stabilization Schemes for BPM Systems.**  
10th International Beam Instrumentation Conference, Pohang (Rep. of Korea), 13 Sep 2021 - 17 Sep 2021.  
PUBDB-2021-04222.

### IPAC21

P. Amstutz and M. Vogt.  
**Investigation of Vlasov Systems with a Certain Class of Linearly-Collective Hamiltonians.**  
12th International Particle Accelerator Conference, Campinas (Brazil), 24 May 2021 - 28 May 2021.  
PUBDB-2021-05624.

F. Brinker, S. Casalbuoni and W. Freund.  
**Correcting the Magnetic Field Offsets Inside the Undulators of the EuXFEL Using the K-Monochromator.**  
12th International Particle Accelerator Conference, Campinas (Brazil), 24 May 2021 - 28 May 2021.  
PUBDB-2021-05174.  
*doi: 10.18429/JACoW-IPAC2021-THPAB080.*

G. Georgiev et al.  
**Beam Preparation with Temporally Modulated Photocathode Laser Pulses for a Seeded THz FEL.**  
12th International Particle Accelerator Conference, Campinas (Brazil), 24 May 2021 - 28 May 2021.  
PUBDB-2021-04717.  
*doi: 10.18429/JACoW-IPAC2021-WEPAB115.*

M. Groß et al.  
**Characterization of Low Emittance Electron Beams Generated by Transverse Laser Beam Shaping.**  
12th International Particle Accelerator Conference, Campinas (Brazil), 24 May 2021 - 28 May 2021.  
PUBDB-2021-04720.  
*doi: 10.18429/JACoW-IPAC2021-WEPAB040.*

J. Keil, I. Agapov and R. Brinkmann.  
**A Lattice for PETRA IV Based on the Combination of Different Arc Cell Designs.**  
12th International Particle Accelerator Conference, Campinas (Brazil), 24 May 2021 - 28 May 2021.  
PUBDB-2021-04868.

M. Krasilnikov et al.  
**Modeling the Magnetic Field of the LCLS-I Undulator for THz@PITZ.**  
12th International Particle Accelerator Conference, Campinas (Brazil), 24 May 2021 - 28 May 2021.  
PUBDB-2021-04723.  
*doi: 10.18429/JACoW-IPAC2021-THPAB049.*

H. Lippek et al.  
**A New Timing System For PETRA IV.**  
12th International Particle Accelerator Conference, Campinas (Brazil), 24 May 2021 - 28 May 2021.  
PUBDB-2021-02176.

G. Loisch.  
**Direct Response time Measurements on Semiconductor Photocathodes.**  
12th International Particle Accelerator Conference, Campinas (Brazil), 24 May 2021 - 28 May 2021.  
PUBDB-2021-04713.  
*doi: 10.3204/PUBDB-2021-04713.*

S. Mohanty et al.  
**Development of Multi-Alkali Antimonides Photocathodes for High-Brightness RF Photoinjectors.**  
12th International Particle Accelerator Conference, Campinas (Brazil), 24 May 2021 - 28 May 2021.  
PUBDB-2021-04721.  
*doi: 10.18429/JACoW-IPAC2021-TUPAB034.*

H. Qian and E. Vogel.  
**Review of High Brightness Photoinjectors.**  
12th International Particle Accelerator Conference, Campinas (Brazil), 24 May 2021 - 28 May 2021.  
PUBDB-2021-04714.  
*doi: 10.3204/PUBDB-2021-04714.*

R. Stark et al.  
**Demonstration of a Novel Longitudinal Phase Space Linearization Method without Higher Harmonics.**  
12th International Particle Accelerator Conference, Campinas (Brazil), 24 May 2021 - 28 May 2021.  
PUBDB-2021-02192.

M. Vogt and J. Zemella.  
**A New 2nd Bunch Compression Chicane for the FLASH2020+ Project.**  
12th International Particle Accelerator Conference, Campinas (Brazil), 24 May 2021 - 28 May 2021.  
PUBDB-2021-05662.  
*doi: 10.18429/JACoW-IPAC2021-TUPAB102.*

### ARIES workshop on Materials and Engineering Technologies for Particle Accelerator Beam Diagnostic Instruments

D. Lipka and S. Vilcins-Czvitkovits.  
**Translation from 3D Simulations to Realization.**  
ARIES workshop on Materials and Engineering Technologies for Particle Accelerator Beam Diagnostic Instruments, Oxford (UK), 21 Jun 2021 - 23 Jun 2021.  
PUBDB-2021-02991.

S. Vilcins-Czvitkovits.  
**Specification Changes of 316 LN ESR after Higher Temperature Procedure - Vacuum Firing and Vacuum Brazing.**  
ARIES workshop on Materials and Engineering Technologies for Particle Accelerator Beam Diagnostic Instruments, Oxford (UK), 21 Jun 2021 - 23 Jun 2021.  
PUBDB-2021-02993.



S. Vilcins-Czvitkovits and M. Lemke.  
**Using of New Sealing Technology for High Precision Wide Open Vacuum Flanges and Waveguide Connections.**  
ARIES workshop on Materials and Engineering Technologies for Particle Accelerator Beam Diagnostic Instruments, Oxford (UK), 21 Jun 2021 - 23 Jun 2021.  
PUBDB-2021-02992.

#### FRPT 2021

Z. Aboulbanine et al.  
**Focused Electron Beams as a Possible Modality for FLASH Radiation Therapy: TOPAS/Geant4 Dosimetry Simulation Study and Performance Investigation.**  
FLASH Radiotherapy and Particle Therapy Conference, Wien (Austria), 1 Dec 2021 - 3 Dec 2021.  
PUBDB-2021-05235.  
*doi: 10.3204/PUBDB-2021-05235.*

H. Qian et al.  
**First Physics Design of Beamline for Electron FLASH Radiation Therapy at PITZ.**  
FLASH Radiotherapy and Particle Therapy Conference, Wien (Austria), 1 Dec 2021 - 3 Dec 2021.  
PUBDB-2021-05222.  
*doi: 10.3204/PUBDB-2021-05222.*

F. Stephan.  
**New R&D Platform with Unique Capabilities for Electron FLASH and VHEE Radiation Therapy and Radiation Biology under Preparation at PITZ.**  
FLASH Radiotherapy and Particle Therapy Conference, Wien (Austria), 1 Dec 2021 - 3 Dec 2021.  
PUBDB-2021-05221.  
*doi: 10.3204/PUBDB-2021-05221.*

#### Virtual DPG Spring Meeting

J. Popp et al.  
**Polarimeter Design for a LPA Electron Beam.**  
Virtual DPG Spring Meeting, Dortmund (Germany), 15 Mar 2021 - 19 Mar 2021.  
PUBDB-2021-04738.

F. P. G. Stehr et al.  
**LEAP: Polarized Electrons from LPA.**  
Virtual DPG Spring Meeting, Dortmund (Germany), 15 Mar 2021 - 19 Mar 2021.  
PUBDB-2021-04739.

#### Other Conference Presentations

A. Bellandi et al.  
**Overview of CW R&D with a European XFEL cryomodule.**  
2021 International Conference on RF Superconductivity, Michigan (USA), 28 Jun 2021 - 2 Jul 2021.  
PUBDB-2021-05503.

H. Cankaya et al.  
**Temporal and Spatial Challenges for Electron Acceleration inside Dielectric Laser Accelerators in the Relativistic Regime.**  
CLEO: Science and Innovations, San Jose (USA), 9 May 2021 - 14 May 2021.  
PUBDB-2022-00704.  
*doi: 10.1364/CLEO\_SI.2021.STh1C.1.*

G. Kube.  
**Development Towards a New BPM System for the PETRA IV Project at DESY.**  
Online Libera Workshop, Solkan (Slovenia), 10 Jun 2021 - 10 Jun 2021.  
PUBDB-2021-04218.

C. A. Lindstroem.  
**Energy-Spread Preservation in a Plasma Accelerator at FLASHForward.**  
IAS Program on High Energy Physics, Hong Kong (virtual) (Hong Kong), 14 Jan 2021 - 14 Jan 2021.  
PUBDB-2021-04442.

C. A. Lindstroem.  
**High-quality Beams from a High-efficiency Plasma Accelerator at DESY's FLASHForward Facility, and beyond.**  
The European Physical Society Conference on High Energy Physics 2021, Hamburg (Virtual) (Germany), 26 Jul 2021 - 30 Jul 2021.  
PUBDB-2021-04443.

C. A. Lindstroem.  
**Self-correcting Beams in a Multistage Plasma Accelerator.**  
5th European Advanced Accelerator Concepts Workshop, Frascati (hybrid/virtual) (Italy), 20 Sep 2021 - 22 Sep 2021.  
PUBDB-2021-04444.

B. List et al.  
**CAD Integration for PETRA-IV.**  
11th International Conference on Mechanical Engineering Design of Synchrotron Radiation Equipment and Instrumentation, Chicago, IL (USA), 27 Jul 2021 - 29 Jul 2021.  
PUBDB-2021-05078.  
*doi: 10.18429/JACOW-MEDSI2020-WEOA01.*

C. Mahnke et al.  
**Synchronizable, low-jitter, picosecond Ho: fiber NALM oscillator for Ho:YLF amplifier driven electron acceleration.**  
CLEO: Applications and Technology, San Jose (California), 9 May 2021 - 14 May 2021.  
PUBDB-2021-03928.  
*doi: 10.1364/CLEO\_AT.2021.JTh3A.10.*

P. Paglovec et al.  
**The RF BPM Electronics Concept and Developments for the PETRA IV Project at DESY.**  
10th MicroTCA Workshop for Industry and Research, Hamburg (Germany), 7 Dec 2021 - 9 Dec 2021.  
PUBDB-2021-05425.

J. Popp et al.  
**LEAP: Polarized Electron Beams from LPA and their Polarimetry.**  
The 24th international spin symposium, Matsue (Japan), 18

Oct 2021 - 22 Oct 2021.  
PUBDB-2021-04737.

M. Seidel et al.  
**Compact 60  $\mu$ J, 60 fs, MHz-rate burst-mode laser for pump-probe experiments at the FLASH FEL facility.**  
Conference on Lasers, Electro-Optics Europe and European Quantum Electronics Conference, Munich (Germany), 21 Jun 2021 - 25 Jun 2021.  
PUBDB-2022-00811.

P. K. Velpula et al.  
**Post-pulse compression of 8.6 mJ pulses using a compact multipass cell.**  
EOS Annual Meeting, Rome (Italy), 13 Sep 2021 - 17 Sep 2021.  
PUBDB-2022-00674.

R. Wanzenberg.  
**PETRA III Status & Upgrade.**  
29th European Synchrotron Light Source (ESLS) Workshop, Grenoble (France), 24 Nov 2021 - 25 Nov 2021.  
PUBDB-2021-05524.

T. Weilbach et al.  
**Status of the THz@PITZ Project – Beam Line Design and Instrumentation.**  
European XFEL Users' Meeting 2021, Hamburg (Germany), 20 Jan 2021 - 25 Jan 2021.  
PUBDB-2021-05238.

## Thesis

#### Ph.D. Thesis

A. Bellandi.  
**LLRF Control Techniques for the European XFEL Continuous Wave Upgrade.**  
University of Hamburg, Hamburg, 2021.

S. Bohlen.  
**Measurement of Electron Parameters using Thomson Scattering.**  
Universtät Hamburg, Hamburg, 2021.

F. Jafarina.  
**Studies on Experiments and Free-Electron laser concepts with a Transverse Gradient Undulator.**  
Universität Hamburg, Hamburg, 2021.

N. M. Lockmann.  
**Noninvasive Measurements of Electron Bunch Current Profiles with Few-Femtosecond Resolution at MHz Repetition Rates.**  
Universität Hamburg, Hamburg, 2021.

R. Niemczyk.  
**Subpicosecond-Resolved Emittance Measurements of High-Brightness Electron Beams with Space Charge Effects at PITZ.**  
University of Hamburg, 2021.

J. Wei.  
**Higher Order Mode-based Beam and Cavity Diagnostics in 1.3 GHz Superconducting Cavities at FLASH.**  
University of Science and Technology of China, Hamburg, 2021.

S. Yamin.  
**First Commissioning of the ARES Focusing System and its Possible Upgrade for Accelerator R&D Experiment.**  
University of Hamburg, 2021.

#### Bachelor Thesis

L. Ebeling.  
**Commissioning of a Calibration Device for Second Sound Based Quench Detection and Reconstruction Analysis.**  
University of Hamburg, 2021.



# FLASH upgrade

New accelerator module for FLASH after installation of the waveguides and during cabling in the Accelerator Module Test Facility (AMTF) (more info: see p. 58)

Picture: Valery Katalev, DESY





### Photographs and graphics

DESY  
European XFEL  
Helmholtz Association  
L+ Landschaftsarchitekten, luminousfields  
Science Communication Lab

Gesine Born, DESY  
Florian Burkart, DESY  
Juan González Díaz, DESY  
Axel Heimken, DESY  
Sören Jalas, DESY  
Ashley Jones, DESY

Valery Katalev, DESY  
Manuel Kirchen, DESY  
Matthias Kreuzeder, DESY  
Freddy Lachmund, DESY  
Carl Lindstrøm, DESY  
Marta Mayer, DESY  
Jörg Modrow, DESY  
Heiner Müller-Elsner, DESY  
Olaf Rasmussen, DESY  
Timm Rohwer, DESY  
Christian Schmid, DESY  
Siegfried Schreiber, DESY  
Paul Andreas Walker, DESY

Burcu Yildirim, DESY  
Dongfang Zhang, DESY

Holger Braack, HAW Hamburg  
Niels Delbos, Universität Hamburg  
Suren Karabekyan, European XFEL  
Rolf Otzipka, Hamburg  
Chenmarev Stanislav, Helmholtz  
Institute Mainz

The figures were reproduced with  
permission of authors or journals.

### Imprint

#### Publishing and contact

Deutsches Elektronen-Synchrotron DESY  
A Research Centre of the Helmholtz Association

Hamburg location:  
Notkestr. 85, 22607 Hamburg, Germany  
Tel.: +49 40 8998-0, Fax: +49 40 8998-3282  
desyinfo@desy.de

Zeuthen location:  
Platanenallee 6, 15738 Zeuthen, Germany  
Tel.: +49 33762 7-70, Fax: +49 33762 7-7413  
desyinfo.zeuthen@desy.de

www.desy.de  
ISBN 978-3-945931-40-0  
doi: 10.3204/PUBDB-2022-01876

#### Editing

Inga Pfeffer  
Ilka Flegel, Kapellendorf

#### Layout

Sabine Kuhls-Dawideit, Büro für Grafik und Design, Halstenbek

#### Production

Kristin Hüttmann

#### Printing

EHS Druck GmbH, Schenefeld

#### Editorial deadline

1 May 2022

#### Editorial note

The authors of the individual scientific contributions published  
in this report are fully responsible for the contents.

### Acknowledgement

We would like to thank all authors and everyone who helped in the creation of this annual report. ●

Reproduction including extracts is permitted subject to crediting the source.  
This report is neither for sale nor may be resold.



**Deutsches Elektronen-Synchrotron DESY**  
**A Research Centre of the Helmholtz Association**

The Helmholtz Association is a community of 18 scientific-technical and biological-medical research centres. These centres have been commissioned with pursuing long-term research goals on behalf of the state and society. The Association strives to gain insights and knowledge so that it can help to preserve and improve the foundations of human life. It does this by identifying and working on the grand challenges faced by society, science and industry. Helmholtz Centres perform top-class research in strategic programmes in six core fields: Energy, Earth & Environment, Health, Aeronautics, Space and Transport, Matter, and Key Technologies.

[www.helmholtz.de](http://www.helmholtz.de)