

Container Specification

INTRODUCTION

Dear Customer,

As one of the leading global ocean carriers, Hapag-Lloyd operates a modern container fleet, offering **innovative transport solutions and suitable container types** to meet your requirements **for any kind of cargo**.

Hapag-Lloyd has always put a strong **focus on product quality, innovation and eco-friendliness**, and maintains an active dialogue with authorities and container manufacturers. Accordingly, the following aspects provide you with additional benefits when placing your transport order:

- Consistently high quality standard of our container equipment through worldwide **certification** and regularly supervised **inspection procedure**
- Adherence to the **latest safety standards**, regulations and all relevant ISO norms
- **Environmentally-sustainable** solutions for preserving natural resources (e.g. steel-floor containers)
- **Energy-efficient** transport of temperature-controlled goods: our reefer fleet provides an **accurate temperature** control and is equipped with the latest technology for better insulation & less power consumption
- Technical design for greater **durability & payload**
- **Greater cargo safety** through additional lashing points
- Covering **special stuffing** & transportation needs with the unique Hapag-Lloyd **Hardtop** containers

At Hapag-Lloyd, we cover a wide range of standard and special containers to ensure that you can **choose exactly the right equipment for your commodity**.

This **container specification booklet** provides guidance on the main technical data for Hapag-Lloyd containers, with a focus on dimensions, weights and design features.

For further advice or verification of your special transport requirements, please do not hesitate to contact your [local Hapag-Lloyd office](#) for assistance.

For additional information about [out-of-gauge cargo, equipment-type groups](#) and [container packing](#) please visit us on our website.

Yours sincerely



Niklas Ohling

Senior Director Container Steering



Frank Nachbar

Director Container Engineering & Maintenance

GENERAL INFORMATION

Maximum gross weights

20' containers:

Up to 32,500 kg (71,650 lbs) for general purpose containers and up to 45,000 kg (99,207 lbs) for Flatracks.

40' and 45' containers:

Up to 32,500 kg (71,650 lbs) for general purpose containers, up to 60,000 kg (123,276 lbs) for Flatracks and 35,000 kg (77,161 lbs) for reefer containers.

Weight limits for road and rail transport

For individually valid limits, contact your local Hapag-Lloyd office.

Floor loads

A container floor is capable of carrying a forklift truck with a maximum axle load of 5,460 kg (12,037 lbs), if the contact area per wheel is at least 142 cm² (22 in²) (ISO 1496/I), whereas **the steel-floor containers** provide a maximum axle load of 9,200 kg (20,282 lbs), valid for all commonly available forklifts.

Concentrated loads

Concentrated loads are loads that are not evenly distributed over the full length of the floor when stowing heavy cargo in containers; as opposed to flats or platforms, special care has to be taken that concentrated loads do not exceed the strength of the bottom construction of the container.

The maximum spread load should not exceed:

- for 20' containers: 4.8 tons (10,582 lbs) per running meter in length, and 7.6 tons (16,755 lbs) for **steel floor containers** only
- for 40' containers: 3 tons per running meter in length, and 6.0 tons (6,614 lbs) for **steel-floor containers** only
- load must not exceed maximum payload

Gooseneck tunnel on 40' containers

All Hapag-Lloyd 40' containers are fitted with a gooseneck tunnel to enable transport on a gooseneck chassis.

Timber treatment

Exposed timber is treated according to Australian, European, Chinese and American requirements.

Container markings

Containers display the ISO size type code. For further information please see page 50.

External and minimum internal dimensions (according to ISO)

The following table gives the overall dimensions and the minimum internal dimensions and door openings for general purpose containers as standardised in ISO 668:

		Length			Width	Height	
Dimensions	mm ft	20' 6,058	40' 12,192	45' 13,716	8' 2,438	8' 6" 2,591	9' 6" 2,896
Minimum internal dimensions	mm ft	5,898 19' 4 ¹ / ₈ "	12,029 39' 5 ¹ / ₂ "	13,556 44' 5 ⁵ / ₈ "	2,350 7' 8 ¹ / ₂ "	2,350 7' 8 ¹ / ₂ "	2,667 8' 9"
Minimum door opening dimensions	mm ft				2,337 7' 8"	2,261 7' 5"	2,565 8' 5"







Tolerances internal dimensions







The internal dimensions and door openings of all Hapag-Lloyd containers correspond to ISO standards. However, the dimensions mentioned on the following pages are nominal figures. Because of production tolerances, a difference in measurement is possible:

Tolerances	Length	Width	Height
	mm ft	mm ft	mm ft
Maximum difference	10 3/8"	10 3/8"	10 3/8"

The container series displayed only represent a sample of the entire fleet.

CONTENTS

			Size	Page
INTRODUCTION & GENERAL INFORMATION				3
General Purpose Container	GENERAL PURPOSE CONTAINER		20' 40'	8 10
	HIGH CUBE GENERAL PURPOSE CONTAINER		40'	12
	HIGH CUBE GENERAL PURPOSE CONTAINER		45'	14
Hardtop Container	HARDTOP CONTAINER		20' 40'	16 18
	HIGH CUBE HARDTOP CONTAINER		40'	20
	ROOF AND DOOR OPENINGS OF HARDTOP CONTAINERS		20' 40' 40'/9'6"	22
Open Top Container	OPEN TOP CONTAINER		20' 40'	24 26
	HIGH CUBE OPEN TOP CONTAINER		40'	28
	ROOF AND DOOR OPENINGS OF OPEN TOP CONTAINERS		20' 40' 40'/9'6"	30

	STEEL-FLOOR CONTAINER - ALL TYPES			32
Platforms / Flats	FLATRACK		20'	34
	HIGH CUBE FLATRACK		40'	36
	PLATFORM (Collapsed Flatrack)		20' 40'	38
Reefer Container	REFRIGERATED CONTAINER (Temperature-controlled container)		20'	40
	HIGH CUBE REFRIGERATED CONTAINER (Temperature-controlled container)		40'	42
	CONTROLLED ATMOSPHERE			44
	TANK CONTAINER		20'	49
	CHANGE OF TEMPERATURE SETPOINT ON REFRIGERATED CONTAINERS			46
	ELECTRIC PLUGS ON REFRIGERATED CONTAINERS			48
	ESSENTIAL CONVERSION FACTORS			50
	CONTAINER SIZE TYPE CODES ACCORDING TO ISO 6346			51

GENERAL PURPOSE CONTAINER

ISO Size Type Code: 22G0, 22G1

20'



- Suitable for any general cargo
- **Fork-lift pockets** for loaded containers
- Various **lashing devices with a permissible load** of 1,000 kg (2,205 lbs) each on the top and bottom longitudinal rails and the corner posts
- Lashing rings on each top longitudinal rail, particularly suitable for the transport of **hanging garment** equipment
- Majority of containers tested and certified for ONE-DOOR-OFF OPERATION, but then with limited stack weight
- Containers may be equipped with **liner bags** suitable for bulk cargo, e. g. malt
- **Floor height** 170 mm (ground level to interior floor surface, tolerance deviation possible)

8' 6" high	Inside dimensions			Door openings		Weights			Capacity	Hapag-Lloyd serial number excerpt	
	Length	Width	Height	Width	Height	Max. gross	Tare	Max. payload			
	mm ft	mm ft	mm ft	mm ft	mm ft	kg lbs	kg lbs	kg lbs	m ³ ft ³		
Wooden floor Steel container with corrugated walls	5,900	2,352	2,393	2,340	2,292	32,500	2,300	30,200	33.2	HLBU	136800–139299
	19' 4¼"	7' 8½"	7' 10¼"	7' 8⅛"	7' 6¼"	71,650	5,071	66,579	1,172		
			2,395							5,181	30,150
	5,898		2,393		2,280	30,480	2,300	28,180	33.0	CPSU	170000–183199
	19' 4⅛"		7' 10¼"		7' 5¾"	67,196	5,071	62,126	1,165		

8' 6" high	Inside dimensions			Door openings		Weights			Capacity	Hapag-Lloyd serial number excerpt	
	Length	Width	Height	Width	Height	Max. gross	Tare	Max. payload			
	mm ft	mm ft	mm ft	mm ft	mm ft	kg lbs	kg lbs	kg lbs	m ³ ft ³		
Steel floor Steel container with corrugated walls	5,900	2,352	2,393	2,340	2,292	32,500	2,250	30,250	33.2	HLBU	171950–173449
	19' 4¼"	7' 8½"	7' 10¼"	7' 8⅛"	7' 6¼"	71,650	4,960	66,690	1,172		
			2,395							5,666	29,930
			7' 10¼"				2,300	30,200		HLBU	136800–139299
							5,071	66,579			

For further information about the steel-floor container, please see page 32.

REMARKS

- 1) 10 lashing rings on each top longitudinal rail; particularly suitable for the transport of hanging garments racks.
- 2) Provided with passive vents.
- 3) Provided with extra lashing rings/bars for the transport of liner bags in the corner posts adjacent to the corner castings.
- 4) For special information please see 20' Hard Top Container.
- 5) Max Gross 30 480 kg

GENERAL PURPOSE CONTAINER

ISO Size Type Code: 42G0, 42G1

40'



- Suitable for any general cargo
- Various **lashing devices with a permissible load** of 1,000 kg (2,205 lbs) each on the top and bottom longitudinal rails and the corner posts
- Lashing rings on each top longitudinal rail, particularly suitable for the transport of **hanging garment** equipment
- Majority of containers tested and certified for ONE-DOOR-OFF OPERATION, but then with limited stack weight
- **Floor height** 170 mm (ground level to interior floor surface, tolerance deviation possible)

GENERAL PURPOSE CONTAINER

40'

8' 6" high	Inside dimensions			Door openings		Weights			Capacity	Hapag-Lloyd serial number excerpt	
	Length	Width	Height	Width	Height	Max. gross kg lbs	Tare kg lbs	Max. payload kg lbs	m ³ ft ³		
Wooden floor Steel container with corrugated walls	12,032	2,352	2,395	2,340	2,292	32,500	3,700	28,800	67.7	HLBU	124400-127699
	39' 5 ⁵ / ₈ "	7' 8 ⁵ / ₈ "	7' 10 ¹ / ₄ "	7' 8 ¹ / ₈ "	7' 6 ¹ / ₄ "	71,650	8,157	63,493	2,391	HLXU	536500-541499
							3,750	28,750		HLBU	112100-114899
							8,267	63,383		HLBU	151600-153899
	12,029	2,350	2,392			30,480	3,780	26,700		HLXU	439700-447168
	39' 5 ¹ / ₂ "	7' 8 ¹ / ₂ "	7' 10 ¹ / ₈ "			67,196	8,333	58,863		HLXU	448000-449999
										HLXU	502000-507749

REMARKS

- 1) 10 lashing rings on each top longitudinal rail; particularly suitable for the transport of hanging garments racks.
- 2) Provided with passive vents.
- 3) Provided with extra lashing rings/bars for the transport of liner bags in the corner posts adjacent to the corner castings.
- 4) For special information please see 20' Hard Top Container.
- 5) Max Gross 30 480 kg

HIGH CUBE GENERAL PURPOSE CONTAINER

ISO Size Type Code: 45G0, 45G1

40'



9'6"
2.9 m

- Suitable for voluminous cargo up to max. 2.70 m (8' 10¼") height
- Various **lashing devices with a permissible load** of 1,000 kg (2,205 lbs) each on the top and bottom longitudinal rails and the corner posts
- Lashing rings on each top longitudinal rail, particularly suitable for the transport of **hanging garment** equipment
- Majority of containers tested and certified for ONE-DOOR-OFF OPERATION, but then with limited stack weight
- **Floor height** 170 mm (ground level to interior floor surface, tolerance deviation possible)
- **Consider over-height for inland transportation** (e.g. bridges, clearances, tunnels etc.)

HIGH CUBE GENERAL PURPOSE CONTAINER

40'

9' 6" high	Inside dimensions			Door openings		Weights			Capacity
	Length	Width	Height	Width	Height	Max. gross	Tare	Max. payload	
	mm ft	mm ft	mm ft	mm ft	mm ft	kg lbs	kg lbs	kg lbs	m ³ ft ³
Wooden floor Steel container with corrugated walls	12,032	2,342	2,700	2,340	2,597	32,500	3,850	28,650	76.3
	39' 5 ⁵ / ₈ "	7' 8 ¹ / ₂ "	8' 10 ¹ / ₄ "	7' 8 ¹ / ₈ "	8' 6 ¹ / ₄ "	71,650	8,488	63,162	2,695
		2,352					3,900	28,600	
		7' 8 ⁵ / ₈ "					8,598	63,052	
	2,342	7' 8 ¹ / ₈ "							

Hapag-Lloyd serial number excerpt	
HLBU	106300–109299
HLBU	114900–116524
HLBU	141100–144399
HLBU	147300–149799
HLBU	128700–133499
HLXU	823250–824749

9' 6" high	Inside dimensions			Door openings		Weights			Capacity
	Length	Width	Height	Width	Height	Max. gross	Tare	Max. payload	
	mm ft	mm ft	mm ft	mm ft	mm ft	kg lbs	kg lbs	kg lbs	m ³ ft ³
Steel floor Steel container with corrugated walls	12,032	2,352	2,700	2,340	2,597	32,500	4,300	28,200	76.4
	39' 5 ⁵ / ₈ "	7' 8 ⁵ / ₈ "	8' 10 ¹ / ₄ "	7' 8 ¹ / ₈ "	8' 6 ¹ / ₄ "	71,650	9,480	62,170	2,698
		2,342					3,950	28,550	76.3
		7' 8 ¹ / ₈ "					8,708	63,603	2,695
							3,830	28,670	
						8,444	63,206		

Hapag-Lloyd serial number excerpt	
HLXU	655900–655999
HLBU	174950–175149
HLBU	127700–128699

For further information about the steel-floor container, please see page 32.

REMARKS

- 1) 10 lashing rings on each top longitudinal rail; particularly suitable for the transport of hanging garments racks.
- 2) Provided with passive vents.
- 3) Provided with extra lashing rings/bars for the transport of liner bags in the corner posts adjacent to the corner castings.
- 4) For special information please see 20' Hard Top Container.
- 5) Max Gross 30 480 kg

HIGH CUBE GENERAL PURPOSE CONTAINER

ISO Size Type Code: L5G0, L5G1

45'



9'6"
—
2.9 m

- Suitable for voluminous cargo up to max. 2.70 m (8' 10¼") height
- Units built with corner castings at 40 ft and 45 ft positions
- Various **lashing devices with a permissible load** of 1,000 kg (2,205 lbs) each on the top and bottom longitudinal rails and the corner posts
- **Floor height** 170 mm (ground level to interior floor surface, tolerance deviation possible)
- **Consider over-height for inland transportation** (e.g. bridges, clearances, tunnels etc.)

HIGH CUBE GENERAL PURPOSE CONTAINER

45'

9' 6" high	Inside dimensions			Door openings		Weights			Capacity	Hapag-Lloyd serial number excerpt	
	Length	Width	Height	Width	Height	Max. gross kg lbs	Tare kg lbs	Max. payload kg lbs	m ³ ft ³		
Wooden floor Steel container with corrugated walls	13,556	2,352	2,700	2,340	2,597	32,500	4,700	27,800	86.0	HLXU	901100-901599
	44' 5 ⁵ / ₈ "	7' 8 ⁵ / ₈ "	8' 10 ¹ / ₄ "	7' 8 ¹ / ₈ "	8' 6 ¹ / ₄ "	71,650	10,362	61,288	3,037	HLXU	900000-900199
						32,500	5,050	27,450	86.0		
						71,650	11,133	60,517	3,037		

REMARKS

- 1) 10 lashing rings on each top longitudinal rail; particularly suitable for the transport of hanging garments racks.
- 2) Provided with passive vents.
- 3) Provided with extra lashing rings/bars for the transport of liner bags in the corner posts adjacent to the corner castings.
- 4) For special information please see 20' Hard Top Container.
- 5) Max Gross 30 480 kg

HARDTOP CONTAINER

ISO Size Type Code: 22U6

20'



- This container type has been **designed and developed by Hapag-Lloyd**
- It has been specially constructed for
 - loading, e.g. by crane, through roof opening and door side
 - **heavy loads**
 - high and **excessively high loads**
- With the roof removed and the door header swung out, it is much easier to load cargo by forklift via the door side
- The steel roof is fitted with forklift rings so that it can be removed by using a forklift. The weight of the steel roof is approx. 450 kg (990 lbs)
- In case your cargo has an over-height, the roof sections can be lashed to a side wall inside the container using only approx. 13 cm (5' 1/8") of space
- Floor height 170 mm (ground level to interior floor surface, tolerance deviation possible)
- If required, we can provide disposable tarpaulins for transport that can be fastened to the walls on the outside using lashing devices
- Forklift pockets for loaded containers
- Can be used for bulk cargo
- Supplied with extra lashing rings/bars for transport of liner bags or hanging garment equipment
- The roof can be easily lifted by hand by 70 mm (2' 3/4"), using the roof-locking devices, so that the door header can be swung out without removing the roof
- Please bear in mind the prevalent weight restrictions for inland transport
- For dimensions of roof and door openings, please see page 22
- For further information, please see our brochure "The Hardtop Container"

8' 6" high	Inside dimensions				Weights			Capacity	Hapag-Lloyd serial number excerpt	
	Length	Width	Height		Max. gross kg lbs	Tare kg lbs	Max. payload kg lbs	m ³ ft ³		
			Middle mm ft	Side mm ft						
Wooden floor	5,895	2,350	2,384	2,309	32,500	2,850	29,650	32.1	HLXU	365650–365949
Steel container with corrugated walls and removable steel roof	19' 4 ¹ / ₈ "	7' 8 ¹ / ₂ "	7' 9 ⁷ / ₈ "	7' 6 ⁷ / ₈ "	71,650	6,283	65,367	1,134	HLXU	365000–365449
	5,886	2,342	2,388	2,313	30,480	2,700	27,780	33.0	HLXU	365450–365649
	19' 3 ³ / ₄ "	7' 8 ¹ / ₈ "	7' 10"	7' 7"	67,196	5,952	61,244	1,165		

Height middle can be used over a width of 2,000 mm (6'6")

REMARKS

- 1) 10 lashing rings on each top longitudinal rail; particularly suitable for the transport of hanging garments racks.
- 2) Provided with passive vents.
- 3) Provided with extra lashing rings/bars for the transport of liner bags in the corner posts adjacent to the corner castings.
- 4) For special information please see 20' Hard Top Container.
- 5) Max Gross 30 480 kg

HARDTOP CONTAINER

ISO Size Type Code: 42U6

40'



This container type has been **designed and developed by Hapag-Lloyd**

- The 40' Hardtop container has been specially constructed for:
 - loading, e.g. by crane, through roof opening and door side
 - long cargo which cannot be loaded into the 40' general container
 - **heavy loads**
 - high and **excessively high loads**
- With the roof removed and the door header swung out, it is much easier to load cargo by forklift via the door side

- The two roof sections are fitted with devices to support lifting by forklift truck or crane. The weight of each steel roof section is approx. 450 kg (990 lbs)
- In case your cargo has an over-height, the roof sections can be lashed to a side wall inside the container using only approx. 13 cm (5' 1/8") of space
- Floor height 170 mm (ground level to interior floor surface, tolerance deviation possible)
- If required, we can provide disposable tarpaulins for transport that can be fastened to the walls on the outside using lashing devices
- The roof can be easily lifted by hand by 70 mm (2' 3/4"), using the roof-locking devices, so that the door header can be swung out without removing the roof
- Please bear in mind the prevalent weight restrictions for inland transport
- Removable turnbuckle positioned dead center between both top rails
- For dimension of roof and door openings, please see page 22
- For further information, please see our brochure "The Hardtop Container"

8' 6" high	Inside dimensions				Weights			Capacity	Hapag-Lloyd serial number excerpt	
	Length	Width	Height		Max. gross kg lbs	Tare kg lbs	Max. payload kg lbs	m ³ ft ³		
			Middle mm ft	Side mm ft						
Wooden floor	12,020	2,342	2388	2,313	30,480	4,700	25,780	67.2	HLXU	465000-465649
Steel container with corrugated walls and removable steel roof	39' 5¼"	7' 8⅛"	7' 10"	7' 7"	67,197	10,362	56,835	2,373	HLXU	467950-467999
		2,345	2,380	2,300				65.3		
		7' 8¼"	7' 9⅝"	7' 6½/12"				2,306		

Height middle can be used over a width of 2,000 mm (6'6")

REMARKS

- 1) 10 lashing rings on each top longitudinal rail; particularly suitable for the transport of hanging garments racks.
- 2) Provided with passive vents.
- 3) Provided with extra lashing rings/bars for the transport of liner bags in the corner posts adjacent to the corner castings.
- 4) For special information please see 20' Hard Top Container.
- 5) Max Gross 30 480 kg

HIGH CUBE HARDTOP CONTAINER

ISO Size Type Code: 45U6

40'



9'6"

2.9 m

This container type has been **designed and developed by Hapag-Lloyd**

- The 40' High Cube Hardtop container has been specially constructed for:
 - loading, e. g. by crane, through roof opening and door side
 - long cargo which cannot be loaded into the 40' general container
 - **heavy loads**
 - high and **excessively high loads**
- With the roof removed and the door header swung out, it is much easier to load cargo by forklift via the door side
- The two roof sections are fitted with devices to support lifting by forklift truck or crane. The weight of each steel roof section is approx. 450 kg (990 lbs)
- In case your cargo has an over-height, the roof sections can be lashed to a side wall inside the container using only approx. 13 cm (5' 1/8") of space
- Floor height 170 mm (ground level to interior floor surface, tolerance deviation possible)
- If required, we can provide disposable tarpaulins for transport that can be fastened to the walls on the outside using lashing devices
- The roof can be easily lifted by hand by 70 mm (2' 3/4"), using the roof-locking devices so that the door header can be swung out without removing the roof
- Please bear in mind the prevalent weight restrictions for inland transport
- Lashing devices – particularly suitable for transport of hanging garments racks
- Removable turnbuckle positioned dead center between both top rails. This may reduce the cargo height, if left in position and not stored
- For further information, please see our brochure "The Hardtop Container"

HIGH CUBE HARDTOP CONTAINER

40'

9' 6" high	Inside dimensions				Weights			Capacity m ³ ft ³
	Length	Width	Height		Max. gross kg lbs	Tare kg lbs	Max. payload kg lbs	
			Middle mm ft	Side mm ft				
Wooden floor	12,032	2,352	2,695	2,620	32,500	5,200	27,300	76.3
Steel container with corrugated walls and removable steel roof	39' 5 ⁵ / ₈ "	7' 8 ⁵ / ₈ "	8' 10 ¹ / ₈ "	8' 7 ¹ / ₈ "	71,650	11,464	60,186	2,695
	12,020	2,342	2,693	2,618	30,480	4,900	25,580	75.8
	39' 5 ¹ / ₄ "	7' 8 ¹ / ₈ "	8' 10"	8' 7"	67,196	10,803	56,394	2,677

Hapag-Lloyd serial number excerpt	
HLXU	666050–666349
HLXU	665000–666049

9' 6" high	Inside dimensions				Weights			Capacity m ³ ft ³
	Length	Width	Height		Max. gross kg lbs	Tare kg lbs	Max. payload kg lbs	
			Middle mm ft	Side mm ft				
Steel floor	12,029	2,350	2,693	2,612	32,500	5,000	27,500	73.9
Steel container with corrugated walls and removable steel roof	39' 5 ¹ / ₂ "	7' 8 ¹ / ₂ "	8' 10"	8' 6 ³ / ₄ "	71,650	11,023	60,627	2,610

Hapag-Lloyd serial number excerpt	
HLBU	803000–803299

For further information about the steel-floor container, please see page 32.

REMARKS

- 1) 10 lashing rings on each top longitudinal rail; particularly suitable for the transport of hanging garments racks.
- 2) Provided with passive vents.
- 3) Provided with extra lashing rings/bars for the transport of liner bags in the corner posts adjacent to the corner castings.
- 4) For special information please see 20' Hard Top Container.
- 5) Max Gross 30 480 kg

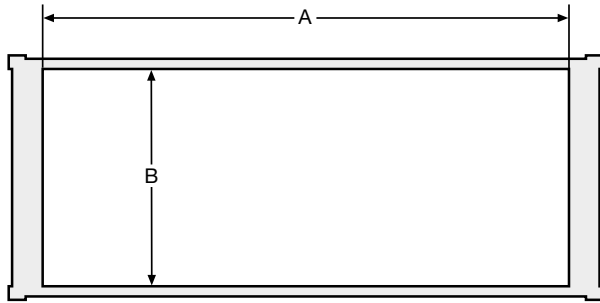

Roof openings

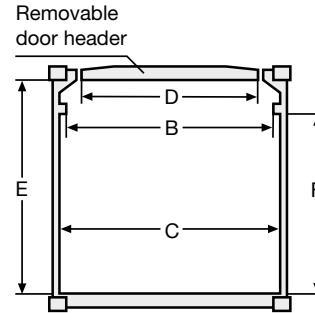

Door openings

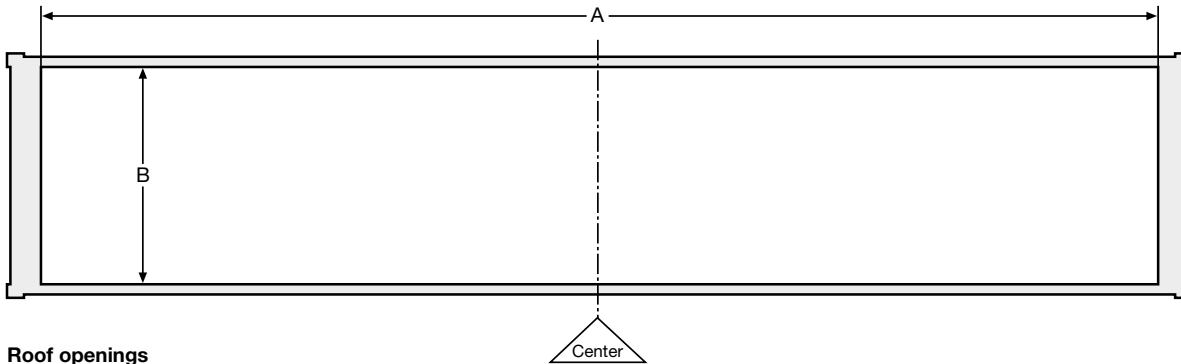

Roof openings

ATTENTION Reduced inside height due to adjust bar, in the center ~ -160 mm

ROOF AND DOOR OPENINGS OF HARDTOP CONTAINERS

20', 40', 40'/9'6"

	Roof openings		Door openings					Roof lashed to side wall		
	Length	Width	Width		Height			Reduced inside width		
	A	B	C	D Swing header opening	B Between top rails	E Up to door header	F Up to top rail	Inside width	Roof opening	Door opening
	mm ft	mm ft	mm ft	mm ft	mm ft	mm ft	mm ft	mm ft	mm ft	mm ft
20' Wooden floor 8' 6" high	5,596 18' 4¼"	2,208 7' 2⅞"	2,340 7' 8⅛"	1,850 6' ¾"	2,208 7' 2⅞"	2,277 7' 5⅝"	2,220 7' ¾"	2,215 7' 3⅛"	2,148 7' ½"	2,212 7' 3"
	5,590 18' 4"		2,336 7' 8"	1,896 6' 2⅝"		2,276 7' 5⅝"		2,209 7' 3"	2,142 7' ¼"	2,206 7' 2⅞"
40' Wooden floor 8' 6" high	11,724 38' 5½"	2,208 7' 2⅞"	2,336 7' 8"	1,896 6' 2⅝"	2,208 7' 2⅞"	2,276 7' 5⅝"	2,220 7' ¾"	2,209 7' 3"	2,142 7' ¼"	2,206 7' 2⅞"
			2,334 7' 7⅞"	1,882 6' 2½"		2,290 7' 6⅛"	2,125 6' 11⅝"	2,205 7' 2¾"	2,102 6' 10¾"	1,996 6' 6½"
40' Wooden floor 9' 6" high	11,724 38' 5½"	2,212 7' 2⅞"	2,340 7' 8⅛"	1,808 5' 11⅛"	2,212 7' 3⅞"	2,581 8' 5⅝"	2,523 8' 3⅜"	2,230 7' 3¾"	2,161 7' 1⅞"	2,227 7' 3⅝"
		2,208 7' 2⅞"	2,336 7' 8"	1,896 6' 2⅝"	2,208 7' 2⅞"	2,597 8' 6¼"	2,525 8' 3⅜"		2,163 7' 1⅞"	
40' Steel floor 9' 6" high	11,730 38' 5¾"	2,214 7' 3⅞"	2,340 7' 8⅛"	1,850 6' ¾"	2,214 7' 3⅞"	2,565 8' 5"	2,520 8' 3¼"	2,230 7' 3¾"	2,165 7' 1¼"	2,227 7' 3⅝"

Hapag-Lloyd serial number excerpt	
HLXU	365650–365449
HLXU	365000–365949
HLXU	365450–365649
HLXU	465000–465649
HLXU	467950–467999
HLXU	666050–666349
HLXU	665000–666049
HLBU	803000–803299

9' 6" high
REMARKS

- 1) 10 lashing rings on each top longitudinal rail; particularly suitable for the transport of hanging garments racks.
- 2) Provided with passive vents.
- 3) Provided with extra lashing rings/bars for the transport of liner bags in the corner posts adjacent to the corner castings.
- 4) For special information please see 20' Hard Top Container.
- 5) Max Gross 30 480 kg

OPEN TOP CONTAINER

ISO Size Type Code: 22U1

20'



- Specially designed for
 - **over-height cargo**
 - **heavy loads**
 - **loading from top side**, e.g. by crane
 - **loading from door side**, e.g. with cargo hanging from overhead tackle
- Floor height 170 mm (ground level to interior floor surface, tolerance deviation possible)
- Door header can be swung out on all open top containers
- If required, we can provide disposable tarpaulins. Using one-way tarpaulins requires that the corner castings be accessible
- For fastening tarpaulins, lashing bars are available on the outside of the walls
- Equipped with forklift pockets for loaded containers
- Numerous lashing devices on the top and bottom longitudinal rails and the corner posts
- Lashing devices have a permissible load of 1,000 kg (2,205 lbs) each
- For dimensions of roof and door openings, please see page 30

8' 6" high	Inside dimensions				Weights			Capacity
	Length mm ft	Width mm ft	Height		Max. gross kg lbs	Tare kg lbs	Max. payload kg lbs	m ³ ft ³
			Middle mm ft	Side mm ft				
Wooden floor Steel container with corrugated walls and removable tarpaulin	5,895 19' 4 1/8"	2,350 7' 8 1/2"	2,380 7' 9 5/8"	2,340 7' 8 1/8"	32,500 71,650	2,450 5,402 2,500 5,512	30,050 66,248 30,000 66,138	32.5 1,148 32.7 1,155

Hapag-Lloyd serial number excerpt	
HLXU	362000–362999
HLXU	360000–361999

8' 6" high	Inside dimensions				Weights			Capacity
	Length mm ft	Width mm ft	Height		Max. gross kg lbs	Tare kg lbs	Max. payload kg lbs	m ³ ft ³
			Middle mm ft	Side mm ft				
Steel floor Steel container with corrugated walls and removable tarpaulin	5,895 19' 4 1/8"	2,352 7' 8 1/2"	2,378 7' 9 5/8"	2,344 7' 8 1/4"	32,500 71,650	2,300 5,071	30,200 66,579	32.5 1,148

Hapag-Lloyd serial number excerpt	
HLBU	801000–801599
HLBU	803300–803619

For further information about the steel-floor container, please see page 32.

REMARKS

- 1) 10 lashing rings on each top longitudinal rail; particularly suitable for the transport of hanging garments racks.
- 2) Provided with passive vents.
- 3) Provided with extra lashing rings/bars for the transport of liner bags in the corner posts adjacent to the corner castings.
- 4) For special information please see 20' Hard Top Container.
- 5) Max Gross 30 480 kg

OPEN TOP CONTAINER

ISO Size Type Code: 42U1

40'



- Specially designed for
 - **over-height cargo**
 - **heavy loads**
 - **loading from top side**, e.g. by crane
 - **loading from door side**, e.g. with cargo hanging from overhead tackle
- Floor height 170 mm (ground level to interior floor surface, tolerance deviation possible)
- Door header can be swung out on all open top containers
- Lashing devices have a permissible load of 1,000 kg (2,205 lbs) each
- For dimensions of roof and door openings, please see page 30

8' 6" high	Inside dimensions				Weights			Capacity
	Length	Width	Height		Max. gross	Tare	Max. payload	
			Middle	Side				
mm ft	mm ft	mm ft	mm ft	kg lbs	kg lbs	kg lbs	m ³ ft ³	
Wooden floor	12,030	2,350	2,377	2,347	30,480	3,850	26,630	66.4
Steel container with corrugated walls and removable tarpaulin	39' 5 ⁵ / ₈ "	7' 8 ¹ / ₂ "	7' 9 ¹ / ₂ "	7' 8 ³ / ₈ "	67,196	8,488	58,708	2,345
	12,029		2,380	2,346	32,500	4,050	28,450	66.5
	39' 5 ¹ / ₂ "		7' 9 ⁵ / ₈ "	7' 8 ³ / ₈ "	71,650	8,929	62,721	2,348

Hapag-Lloyd serial number excerpt	
HLXU	461670-461819
HLXU	560300-566699

8' 6" high	Inside dimensions				Weights			Capacity
	Length	Width	Height		Max. gross	Tare	Max. payload	
			Middle	Side				
mm ft	mm ft	mm ft	mm ft	kg lbs	kg lbs	kg lbs	m ³ ft ³	
Steel floor	12,029	2,350	2,380	2,344	32,500	4,000	28,500	66.3
Steel container with corrugated walls and removable tarpaulin	39' 5 ¹ / ₂ "	7' 8 ¹ / ₂ "	7' 9 ⁵ / ₈ "	7' 7 ¹ / ₄ "	71,650	8,819	62,831	2,341

Hapag-Lloyd serial number excerpt	
HLBU	800000-800999
HLBU	801600-802099

For further information about the steel-floor container, please see page 32.

REMARKS

- 1) 10 lashing rings on each top longitudinal rail; particularly suitable for the transport of hanging garments racks.
- 2) Provided with passive vents.
- 3) Provided with extra lashing rings/bars for the transport of liner bags in the corner posts adjacent to the corner castings.
- 4) For special information please see 20' Hard Top Container.
- 5) Max Gross 30 480 kg

HIGH CUBE OPEN TOP CONTAINER

ISO Size Type Code: 45U1

40'



9'6"
2.9 m

- Specially designed for
 - **over-height cargo**
 - **heavy loads**
 - **loading from top side**, e.g. by crane
 - **loading from door side**, e.g. with cargo hanging from overhead tackle
- Provides **305 mm (1')** extra internal loading height compared to a normal 40' Open Top Container
- Provides higher point loads and resistance capability than the 40' Open Top Container
- Provides **8 m³ (283 cu.ft)** more loading capacity compared to a normal 40' Open Top Container
- Container built with **innovative Hapag-Lloyd steel floor**
- For further information, please see our brochure "40' High Cube Open Top Container"

HIGH CUBE OPEN TOP CONTAINER

40'

9' 6" high	Inside dimensions				Weights			Capacity
	Length	Width	Height		Max. gross kg lbs	Tare kg lbs	Max. payload kg lbs	Capacity m ³ ft ³
			Middle mm ft	Side mm ft				
Steel floor	12,029	2,352	2,683	2,649	32,500	4,250	28,250	74.9
Steel container with corrugated walls and removable tarpaulin	39' 5½"	7' 8⅝"	8' 9⅝"	8' 8¼"	71,650	9,370	62,280	2,645

Hapag-Lloyd serial number excerpt	
HLBU	802100-802599

For further information about the steel-floor container, please see page 32.

REMARKS

- 1) 10 lashing rings on each top longitudinal rail; particularly suitable for the transport of hanging garments racks.
- 2) Provided with passive vents.
- 3) Provided with extra lashing rings/bars for the transport of liner bags in the corner posts adjacent to the corner castings.
- 4) For special information please see 20' Hard Top Container.
- 5) Max Gross 30 480 kg

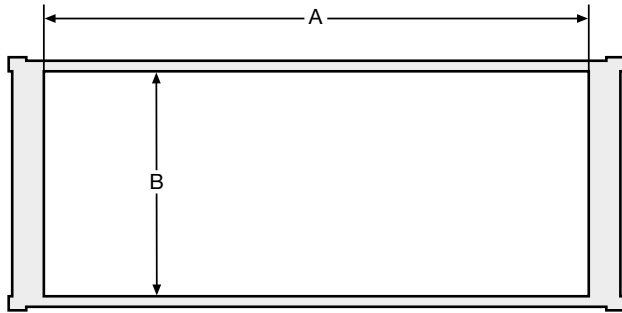

Roof openings

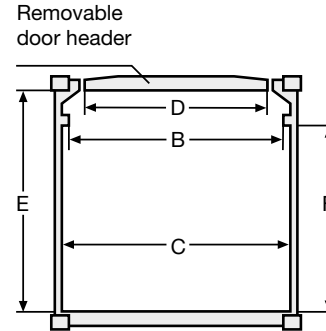

Door openings

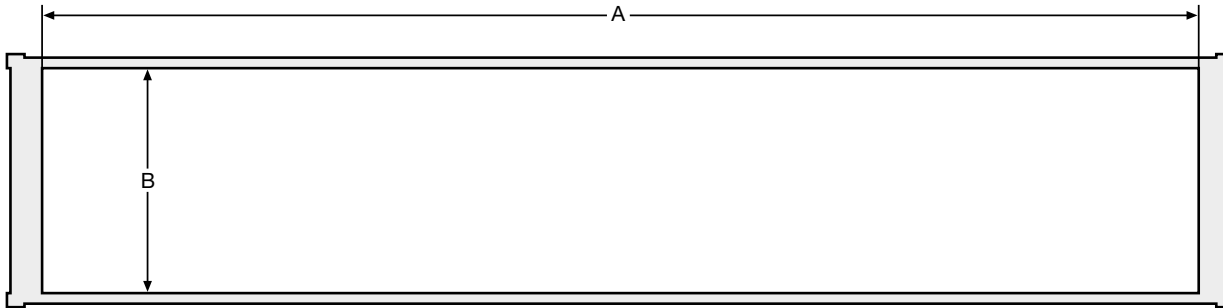

Roof openings

ROOF AND DOOR OPENINGS OF OPEN TOP CONTAINERS

20', 40', 40'/9'6"

	Roof openings		Door openings					
	Length	Width	Width			Height		
	A	B	C	D Swing header opening	B Between top rails	E Up to door header	F Up to top rail	
	mm ft	mm ft	mm ft	mm ft	mm ft	mm ft	mm ft	
20' Wooden floor 8' 6" high	5,338 17' 6 ¹ / ₈ "	2,230 7' 3 ³ / ₈ "	2,338 7' 8"	1,900 6' 2 ³ / ₄ "	2,230 7' 3 ³ / ₈ "	2,280 7' 5 ³ / ₄ "	2,231 7' 3 ³ / ₄ "	HLXU 362500–362999 HLXU 360000–361999
Steel floor 8' 6" high	5,418 17' 9 ¹ / ₄ "	2,232 7' 3 ⁷ / ₈ "	2,340 7' 8 ¹ / ₈ "	1,900 6' 2 ³ / ₄ "	2,232 7' 3 ⁷ / ₈ "	2,280 7' 5 ³ / ₄ "	2,230 7' 3 ³ / ₄ "	HLBU 801000–801599 HLBU 803300–803619
40' Wooden floor 8' 6" high	11,573 37' 11 ⁵ / ₈ "	2,210 7' 3"	2,338 7' 8"	1,902 6' 2 ⁷ / ₈ "	2,210 7' 3"	2,292 7' 6 ¹ / ₄ "	2,131 6' 11 ⁷ / ₈ "	HLXU 461670–461819 HLXU 560300–566699
	11,552 37' 10 ³ / ₄ "	2,230 7' 3 ³ / ₈ "	2,340 7' 8 ¹ / ₈ "	1,900 6' 2 ³ / ₄ "	2,230 7' 3 ³ / ₈ "	2,282 7' 5 ⁷ / ₈ "	2,163 7' 1 ¹ / ₈ "	
Steel floor 8' 6" high	11,552 37' 10 ³ / ₄ "	2,232 7' 3 ⁷ / ₈ "	2,352 7' 8 ⁵ / ₈ "	1,902 6' 2 ⁷ / ₈ "	2,232 7' 3 ⁷ / ₈ "	2,280 7' 5 ³ / ₄ "	2,131 6' 11 ⁷ / ₈ "	HLBU 800000–800999 HLBU 801600–802099
Steel floor 9' 6" high	11,552 37' 10 ³ / ₄ "	2,192 7' 2 ¹ / ₄ "	2,352 7' 8 ⁵ / ₈ "	1,900 6' 2 ³ / ₄ "	2,192 7' 2 ¹ / ₄ "	2,570 8' 5 ¹ / ₈ "	2,435 7' 11 ⁷ / ₈ "	HLBU 802100–802599

REMARKS

- 1) 10 lashing rings on each top longitudinal rail; particularly suitable for the transport of hanging garments racks.
- 2) Provided with passive vents.
- 3) Provided with extra lashing rings/bars for the transport of liner bags in the corner posts adjacent to the corner castings.
- 4) For special information please see 20' Hard Top Container.
- 5) Max Gross 30 480 kg

STEEL-FLOOR CONTAINER – ALL TYPES

The steel-floor container has been nominated as a finalist in various innovation and efficiency award categories. Designed and developed by Hapag-Lloyd, it offers the following advantages:

Solid

- Lighter than containers with the traditional or hybrid floor that leads to **additional payload**
- Higher certified point loads and resistance capability
- Higher stability during the lifetime guaranteed

Eco-friendly

- More sustainable
- Longer life cycle without wear and tear
- 100 % recyclable

Clean

- Almost odourless
- Easier, cheaper and faster to clean
- No use of chemical treatments needed
- Easier to prepare for food grade shipments

Secure

- Certified by DNV–GL and BV (Bureau Veritas)
- More cargo-securing devices than industry standard



	Inside dimensions			Door openings		Weights			Capacity	Hapag-Lloyd serial number excerpt		
	Length	Width	Height	Width	Height	Max. gross	Tare	Max. payload	m ^C ft ³			
22G1 8' 6" high	mm ft	mm ft	mm ft	mm ft	mm ft	kg lbs	kg lbs	kg lbs		33.2 1,172		
	5,900 19' 4¼"	2,352 7' 8⅝"	2,393 7' 10¼"	2,340 7' 8⅛"	2,292 7' 6¼"	32,500 71,650	2,250 4,960	30,250 66,690			HLBU	171950–173449
			2,395 7' 10¼"				2,570 5,666	29,930 65,984			HLBU	173450–174949
							2,300 5,071	30,200 66,579			HLXU	340700–340799
											HLBU	136800–139299

STEEL-FLOOR CONTAINER – ALL TYPES

45G1 9' 6" high	Inside dimensions			Door openings		Weights			Capacity	Hapag-Lloyd serial number excerpt	
	Length	Width	Height	Width	Height	Max. gross kg lbs	Tare kg lbs	Max. payload kg lbs	m ³ ft ³		
	mm ft	mm ft	mm ft	mm ft	mm ft						
12,032 39' 5 ⁵ / ₈ "	2,352 7' 8 ⁵ / ₈ "	2,700 8' 10 ¹ / ₄ "	2,340 7' 8 ¹ / ₈ "	2,597 8' 6 ¹ / ₄ "	32,500 71,650	4,300 9,480	28,200 62,170	76.4 2,698	HLXU	655900–655999	
	2,342 7' 8 ¹ / ₈ "					3,950 8,708	28,850 63,603	76.3 2,695	HLBU	174950–175149	
						3,830 8,444	28,670 63,206		HLBU	127700–128699	

	Inside dimensions				Weights			Capacity	Hapag-Lloyd serial number excerpt	
	Length	Width	Height		Max. gross kg lbs	Tare kg lbs	Max. payload kg lbs	m ³ ft ³		
			Middle mm ft	Side mm ft						
22U1 8' 6" high	5,895 19' 4 ¹ / ₈ "	2,352 7' 8 ¹ / ₂ "	2,378 7' 9 ⁵ / ₈ "	2,344 7' 8 ¹ / ₄ "	32,500 71,650	2,300 5,071	30,200 66,579	32.5 1,148	HLBU	801000–801599
									HLBU	803300–803619
42U1 8' 6" high	12,029 39' 5 ¹ / ₂ "	2,350 7' 8 ¹ / ₂ "	2,380 7' 9 ⁵ / ₈ "	2,344 7' 7 ¹ / ₄ "	32,500 71,650	4,000 8,819	28,500 62,831	66.3 2,341	HLBU	800000–800999
									HLBU	801600–802099
45U1 9' 6" high	12,029 39' 5 ¹ / ₂ "	2,352 7' 8 ⁵ / ₈ "	2,683 8' 9 ⁵ / ₈ "	2,649 8' 8 ¹ / ₄ "	32,500 71,650	4,250 9,370	28,250 62,280	74.9 2,645	HLBU	802100–802599
45U6RKS 9' 6" high	12,029 39' 5 ¹ / ₂ "	2,350 7' 8 ¹ / ₂ "	2,693 8' 10"	2,612 8' 6 ³ / ₄ "	32,500 71,650	5,000 11,023	27,500 60,627	73.9 2,610	HLBU	803000–803299

- 1) 10 lashing rings on each top longitudinal rail, particularly suitable for the transport of hanging garments racks.
- 2) Provided with passive vents.
- 3) Provided with extra lashing rings/bars for the transport of liner bags in the corner posts adjacent to the corner castings.
- 4) For special information please see 20' Hard Top Container.
- 5) Max Gross 30 480 kg



- Suitable for **heavy loads and oversized cargo**
- Equipped with fork-lift pockets for loaded containers
- Numerous **very strong lashing devices** on the corner posts, longitudinal rails and on base ends
- Lashing devices have a permissible load up to 5,000 kg (11,023 lbs) each
- Maximum payload can only be used if cargo weight is distributed over the total floor area of Flatrack
- If heavy loads are shorter, the payload is reduced. Please contact your Hapag-Lloyd office for stowage advice
- Flatracks are delivered without stanchions. If stanchions are required, please inform us upon booking
- Flatracks are equipped with spring-assisted collapsible end walls and twistlocks to interlock 7 units into a 8'6" high pile
- Timber-treated according to Australian requirements
- Welding on Flatracks is not allowed

8' 6" high	Inside dimensions					Weights			Hapag-Lloyd serial number excerpt		
	Length between corner posts mm ft	Width between corner posts mm ft	Width over floor/ bottom side rails mm ft	Height floor to top face (inside height) mm ft	Height of bottom mm ft	Max. gross kg lbs	Tare kg lbs	Max. payload kg lbs			
Flat/Platform with flushfolding end walls and softwood floor	5,612 18' 4 ⁷ / ₈ "	2,227 7' 3 ⁵ / ₈ "	2,210 7' 3"	2,219 7' 3 ³ / ₈ "	370 1' 2 ¹ / ₂ "	34,000 74,957	2,740 6,041	31,260 68,916	HLXU	268800–269199	
	5,638 18' 6"		2,208 7' 2 ⁷ / ₈ "	2,235 7' 4"		40,000 88,184			2,940 6,482	37,060 81,702	HLXU
			2,194 7' 2 ³ / ₈ "	2,233 7' 3 ⁷ / ₈ "	45,000 99,207	2,900 6,393	42,100 92,814	HLXU	368000–368699	HLXU	368700–369199

REMARKS

- 1) 10 lashing rings on each top longitudinal rail; particularly suitable for the transport of hanging garments racks.
- 2) Provided with passive vents.
- 3) Provided with extra lashing rings/bars for the transport of liner bags in the corner posts adjacent to the corner castings.
- 4) For special information please see 20' Hard Top Container.
- 5) Max Gross 30 480 kg

HIGH CUBE FLATRACK

ISO Size Type Code: 45P3

40'

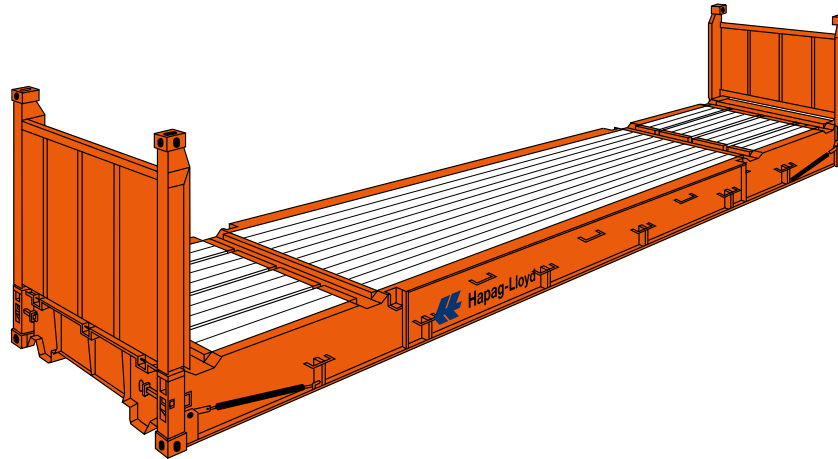

9'6"
2.9 m

- Suitable for **heavy loads and oversized cargo**
- Extraordinary, **very strong frame design with strong end walls** allowing bracing and stacking
- Flatracks are equipped with spring-assisted collapsible flushfolding end walls and twistlocks to interlock 4 units into a 8' 6" high pile
- Usable as "tween decks" in cargo holds and on hatch covers for break bulk cargoes
- Numerous **very strong lashing devices** on longitudinal rails and base ends have a permissible load up to 5,000 kg (11,023 lbs) each
- Gooseneck tunnel on both ends of 40' High Cube Flats
- The permissible payload of the Flatrack depends on the resting length of the cargo on the Flatracks side rails
- Maximum payload can only be used if cargo weight is distributed over the full length of the side rails
- If heavy loads are shorter, the payload is reduced. Please contact your Hapag-Lloyd office for stowage advice
- Heavy cargo must rest on the main girder
- Flatracks are delivered without stanchions
- Timber-treated according to Australian requirements
- Welding on Flatracks is not allowed

PLATFORM (COLLAPSED FLATRACK)

ISO Size Type Code: according to Flat Series

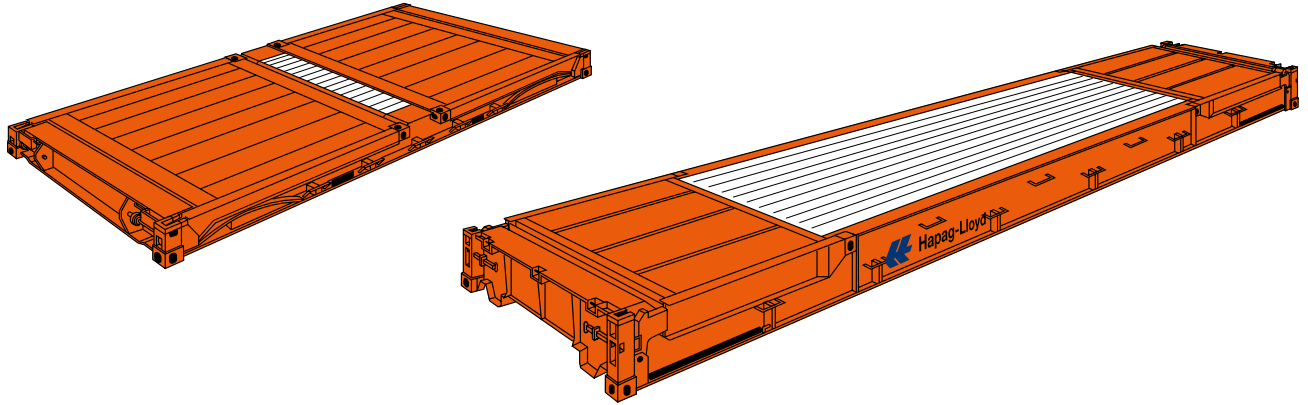

- Suitable for **heavy loads and oversized length cargo**
- Modified **bottom** construction designed for loads up to **60,000 kg** (123,276 lbs)
- Gooseneck tunnel on both ends of 40' platforms
- Easy handling/transportation:
 - 20' interlocked pile of max. 7 units
 - 40' interlocked pile of max. 4 units
 - Combined height of less than 2,591 mm/8' 6"
- Timber-treated according to Australian requirements
- Numerous **very strong lashing devices**
- Allows for transport of heavy loads concentrated on a small load surface area of the floor
- **If you have special requirements for large and heavy cargoes exceeding below platform limitations, please contact your local Hapag-Lloyd office**
- **Individual solution planning for your scenario may already be worked out or can be calculated on short notice**
- For **break bulk** shipments, the static load for 40' Platforms is up to **85,000 kg** (187,390 lbs) as foundation base
- For other features please, refer to respective Flatrack series

PLATFORM (COLLAPSED FLATRACK)

20'	Inside dimensions			Weights			Hapag-Lloyd serial number excerpt
	Length	Width	Height of bottom	Max. gross	Tare	Max. payload	
	mm ft	mm ft	mm ft	kg lbs	kg lbs	kg lbs	
Flat/Platform with flushfolding end walls and softwood floor 1' 1¼" high	6,058 20'	2,438 8'	370 1' 2½"	34,000 74,957	2,740 6,041	31,260 68,916	HLXU 268800–269199 268600–268799
				40,000 88,184	2,940 6,482	37,060 81,702	HLXU 368000–368699
				45,000 99,207	2,900 6,393	42,100 92,814	HLXU 368700–369199

40'	Inside dimensions			Weights			Hapag-Lloyd serial number excerpt
	Length	Width	Height of bottom	Max. gross	Tare	Max. payload	
	mm ft	mm ft	mm ft	kg lbs	kg lbs	kg lbs	
Flat/Platform with flushfolding end walls and softwood floor 2" high	12,192 40'	2,245 7' 4¾"	648 2' 1½"	50,000 110,230	5,950 13,117	44,050 97,113	HLXU 669800–669899
				55,000 121,253	5,900 13,007	49,100 108,246	HLXU 869000–869599
					5,850 12,897	49,150 108,356	HLXU 868000–868499
				60,000 132,276	5,800 12,787	54,200 119,489	HLBU 802700–802999

REMARKS

- 1) 10 lashing rings on each top longitudinal rail; particularly suitable for the transport of hanging elements
- 2) Provided with passive vents.
- 3) Provided with extra lashing rings/bars for the transport of liner bags in the corner posts adjacent to the corner castings.
- 4) For special information please see 20' Hard Top Container.
- 5) Max Gross 30 480 kg

REFRIGERATED CONTAINER (TEMPERATURE-CONTROLLED CONTAINER)

ISO Size Type Code: 22R1, 22R9

20'

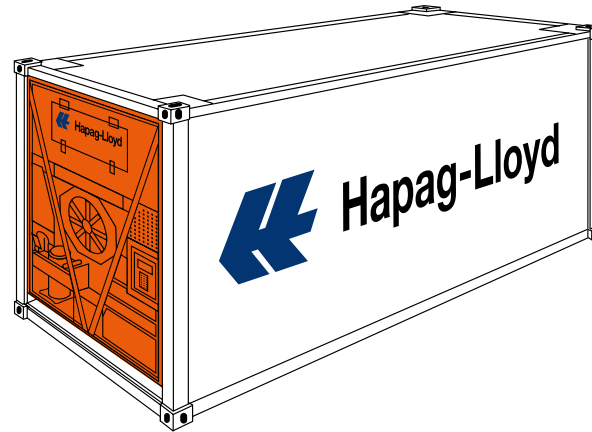

- Low CO₂ footprint due to less power-consuming refrigeration technology
- Pre-Trip Inspection (PTI) and maintenance procedure prior to each shipment
- Container built and tested to fulfil or even exceed industrial standards and regulations
- Constant high airflow for perishable products guarantees best temperature maintenance
- Hygienically designed sealing-free container with side lining protecting scuff lining
- Container certified for cold treatment control e.g. meeting requirement of the USDA
- Contemporary insulation factors
- Low tare weight offers advantage of high payload designed container
- Dedicated equipment available for non-foodstuff cargoes
- Container available to maintain temperature control range as low as -40°C up to +30°C
- Container built to maintain temperature in ambient environment up to 50°C
- Multi-temperature setting (MTS) option available
- “On demand” defrosting assists to avoid unnecessary heat supply
- Reefer containers equipped with de-humidification option (including sensor)
- Maximum stowage height indicated by red line inside the container in order to ensure proper air circulation
- ATO-DLO certified by Agrotechnological Research Institute e.g. for flower bulb transportation, bulb mode option available
- All containers are suitable for shore power supply, voltages: 380V / 50 Hz to 460V / 60Hz
- For the technical specification and illustration of electric plug, see page 48

REFRIGERATED CONTAINER (TEMPERATURE-CONTROLLED CONTAINER)

20'

8' 6" high	Inside dimensions				Door openings		Weights			Capacity	Hapag-Lloyd serial number excerpt				
	Length	Width	Height	Max. stow. height (to load line)	Width	Height	Max. gross	Tare	Max. payload	Capacity					
	mm ft	mm ft	mm ft	mm ft	mm ft	mm ft	kg lbs	kg lbs	kg lbs	m ³ ft ³					
	5,450 17' 10½"	2,284 7' 5⅞"	2,267 7' 5¼"	2,184 7' 2"	2,290 7' 6⅛"	2,264 7' 5⅛"	30,480 67,196	2,905 6,404	27,575 60,792	28.2 996	HLXU	371450–371949			
		2,280 7' 5¾"	2,259 7' 4⅞"	2,159 7' 1"			32,000 70,547	2,860 6,305	29,140 64,242	28.1 1,006	HLXU	374050–375049			
	5,446 17' 10¾"	2,293 7' 6¼"	2,255 7' 4¾"	2,155 7' 7⁄8"			2,252 7' 4⁵⁄8"	30,480 67,196	2,920 6,437	27,560 60,759	28.2 996	HLXU	372800–373799		
	5,454 17' 10¾"	2,290 7' 6⅛"	2,263 7' 5⅛"	2,163 7' 1⅛"				31,400 69,220	2,770 6,110	28,630 63,118	HLXU	375350–375849			
	Non-Foodstuff	5,535 18' 1⅛"	2,316 7' 7⅛"	2,331 7' 7¾"			2,211 7' 3"	2,316 7' 7⅛"	2,290 7' 6⅛"	30,480 67,196	3,030 6,680	27,450 60,516	29.9 1,056	HLXU	171150–171249
			2,284 7' 5⅞"	2,270 7' 5¾"			2,150 7' 5⁄8"	2,290 7' 6⅛"	2,264 7' 5⅛"	30,480 67,196	2,900 6,393	27,580 60,803	28.7 1,014	HLXU	171250–171643

REMARKS

- 1) 10 lashing rings on each top longitudinal rail; particularly suitable for the transport of hanging garments racks.
- 2) Provided with passive vents.
- 3) Provided with extra lashing rings/bars for the transport of liner bags in the corner posts adjacent to the corner castings.
- 4) For special information please see 20' Hard Top Container.
- 5) Max Gross 30 480 kg

REFRIGERATED CONTAINER (TEMPERATURE-CONTROLLED CONTAINER)

ISO Size Type Code: 45R1 High Cube, 45R9

40'



- Low CO₂ footprint due to less power-consuming refrigeration technology
- Pre-Trip Inspection (PTI) and maintenance procedure prior each shipment
- Container built and tested to fulfill or even exceed industrial standards and regulations
- Constant high airflow for perishable products guarantees best temperature maintenance
- Hygienically designed sealing-free container with side lining protecting scuff lining
- Container certified for cold treatment control e.g. meeting requirement of the USDA
- Contemporary insulation factors
- Low tare weight offers advantage of high payload designed container
- Dedicated equipment available for non-foodstuff cargoes
- Container available to maintain temperature control range as low as -40°C up to +30°C
- Container built to maintain temperature in ambient environment up to 50°C
- Multi-temperature setting (MTS) option available
- “On demand” defrosting assists to avoid unnecessary heat supply
- Reefer containers equipped with de-humidification option (including sensor)
- Maximum stowage height indicated by red line inside the container in order to ensure proper air circulation
- Tailor-made atmosphere (TMA) via gas injection (controlled atmosphere technology) available
- ATO-DLO certified by Agrotechnological Research Institute e.g. for flower bulb transportation, bulb mode option available
- All containers are suitable for shore power supply, voltages: 380V / 50 Hz to 460V / 60Hz
- For the technical specification and illustration of electric plug, see page 48

REFRIGERATED CONTAINER (TEMPERATURE-CONTROLLED CONTAINER)

40'

9' 6" high	Inside dimensions				Door openings		Weights			Capacity	Hapag-Lloyd serial number excerpt	
	Length	Width	Height	Max. stow. height (to load line)	Width	Height	Max. gross	Tare	Max. payload			
	mm ft	mm ft	mm ft	mm ft	mm ft	mm ft	kg lbs	kg lbs	kg lbs	m ³ ft ³		
	11,578 37' 11¼"	2,280 7' 5¾"	2,525 8' 3¾"	2,425 7' 11½"	2,276 7' 5⅝"	2,535 8' 3¾"	34,000 74,957	4,300 9,480	29,700 65,477	66.7 2,356	HLXU	676100 - 676599
	11,599 38' ¼"	2,290 7' 6⅛"	2,545 8' 4⅛"		2,290 7' 6⅛"	2,557 8' 4⅝"	34,000 74,956	4,420 9,744	29,580 65,212	67.6 2,387	HLXU	877530-880529
	11,580 37' 11⅞"	2,290 7' 6⅛"	2,540 8' 4"	2,420 7' 11¼"		2,569 8' 5⅛"	34,000 74,957	4,450 9,810	29,550 45,146	67.3 2,380	HLXU	870000-872099
Controlled atmosphere technology (ExtraFresh)	11,590 38' ¼"	2,290 7' 6⅛"	2,540 8' 4"	2,420 7' 11 1/4"			34,000 74,956	4,570 10,075	29,430 64,881	67.4 2,381	HLBU	904000-904999
Controlled atmosphere technology (EverFresh)		2,280 7' 5¾"					34,000 74,956	4,800 10,582	29,200 64,374	67.4 2,380	LNXU	965000-965999
Non-Foodstuff	11,580 37' 11⅞"	2,290 7' 6⅛"	2,543 8' 4⅛"	2,423 7' 11¾"	2,294 7' 6¼"	2,550 8' 4¾"	34,000 74,957	4,550 10,031	29,450 64,925	67.4 2,380	HLXU	777000-777484
	11,590 38' ¼"	2,294 7' 6¼"	2,594 8' 6⅛"	2,474 8' 1¾"	2,290 7' 6⅛"	2,569 8' 5⅛"	34,000 74,956	4,660 10,273	29,340 64,683	67.9 2,398	HLXU	777500-777699

REMARKS

- 1) 10 lashing rings on each top longitudinal rail; particularly suitable for the transport of hanging garments racks.
- 2) Provided with passive vents.
- 3) Provided with extra lashing rings/bars for the transport of liner bags in the corner posts adjacent to the corner castings.
- 4) For special information please see 20' Hard Top Container.
- 5) Max Gross 30 480 kg

CONTROLLED ATMOSPHERE

With the ability to change the composition of the air in a reefer container, the ripening process of “living” cargo such as fruit or plants can be effectively controlled.

Product	Tech. description
Your main advantages are	The products reach their destination considerably fresher and in better quality
	Products can be transported over greater distances, opening up new market potential
	Shipments in our refrigerated containers are a real cost-effective alternative to airfreight
	Provides flexibility of goods carried in the supply chain

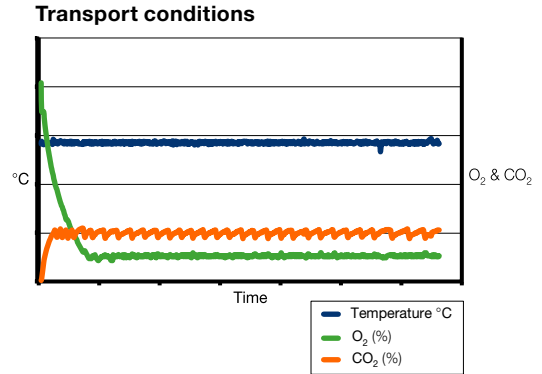

To meet your specific individual requirements, we offer the following Controlled Atmosphere technologies:

ExtraFresh	A technology designed to control and preserve the desired transport atmosphere for fruits and vegetables
	Hapag-Lloyd ExtraFresh takes advantage of the natural fruit respiration process to slow down the ripening
	Maintain the cargo’s quality and extend the product’s shelf life
	Hapag-Lloyd ExtraFresh containers are equipped with oxygen (O ₂) and carbon dioxide (CO ₂) sensors and an automatic fresh air ventilation system – to provide the optimum transport conditions for your fruits and vegetables. In addition, ethylene scrubbers are available for sensitive cargoes. Typical products for “ExtraFresh” technology include avocados, bananas and mangoes.

EverFresh

EverFresh **preserves freshness** with absolute control

Produces its own atmosphere and actively controls this with adjustable setpoints for both oxygen and carbon dioxide

Allows for active nitrogen (N₂) and carbon dioxide (CO₂) injection during transport

System is **fully integrated into the container unit** and operates autonomously without special technical support

EverFresh technology is especially beneficial for sensitive cargo with high CO₂ requirements, such as blueberries.

Air Exchange Management (AEM)

Technologies like AFAM+, AV+ or eAutoFresh offer the following benefits:

Natural CO₂ respiration of the cargo and on-demand ventilation can increase and hold the CO₂ content inside the reefer

This results in a **delayed ripening process**

All these systems are **suitable for climatic products** with high CO₂ respiration rates

Tailor-made atmosphere (TMA) (like **Liventus & Maxtend**)

Uses the same principle as AFAM+, eAutoFresh, AV+

Here, an **individual gas mixture** (N₂ and CO₂) is **initially injected** into the reefer

The system modifies and preserves the desired atmosphere for fruits and vegetables to delay ripening

The use of these technologies compared to AEM provides **additional quality assurance** for your product







CHANGE OF TEMPERATURE SETPOINT ON REFRIGERATED CONTAINERS



Thermo King





To change the controller setpoint, turn the **UNIT ON/OFF** switch **ON**.

Complete the following steps:

1. Press the  key.
2. Press the  or  key to scroll to **TEMP SETP** line.
3. Press the  key. For a minus setpoint, press the  key first. Type the new temperature setpoint in using the general purpose keypad.
4. Press and hold the  key until the cursor stops flashing. The new setpoint appears in the LCD display.
5. Press the  key to exit the menu.





Thermo King (MP4000)

1. Press the  key.
2. Press the  or  key to change the setpoint.
3. Press and hold the  key until you are returned to the main screen. The new setpoint appears in the LCD display.



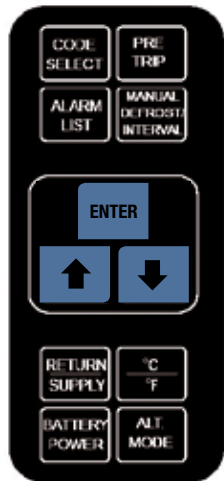

CHANGE OF TEMPERATURE SETPOINT ON REFRIGERATED CONTAINERS

Carrier

1. Press the  or  key to change the setpoint (the left display will blink).
2. Press the  key at the desired setting to confirm and exit the selection menu.



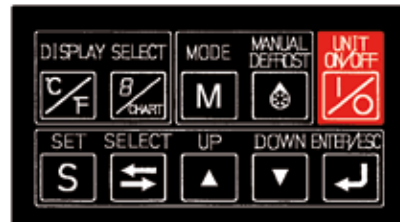

Daikin

1. Press the  key to scroll to "SET-SPC".
2. Press the  or  key to change the setpoint.
3. Press the  key to set desired setting and exit the menu.



MCI - StarCool

Change the temperature setpoint

1. Press the  or  key to change the setpoint.
2. Press the  key for 3 seconds at the desired setting to confirm and exit the menu.

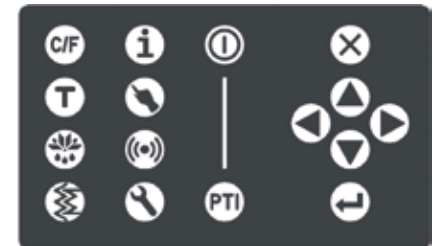

ELECTRIC PLUG ON REFRIGERATED CONTAINERS

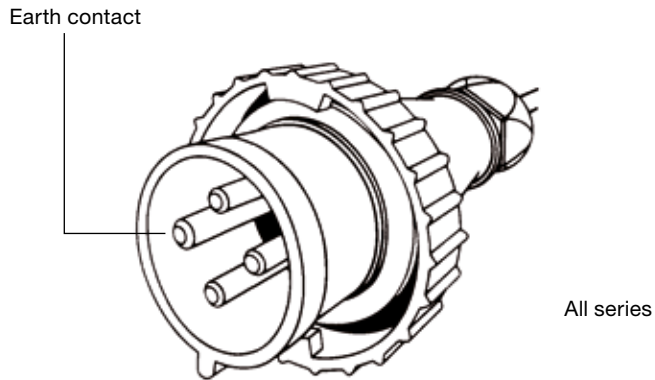

- Refrigerated containers are equipped with a 380 V/50 Hz to 460 V/60 Hz (32 A) plug
 - There are fixed cables with a length of up to 18 m (49 ft)
 - Couplings for adapters are available
 - **Adapters are subject to corresponding safety regulations**
- 380/460 V plugs:
- 4 poles according to CEE
 - According to ISO 1496-2 annex M
 - **Earth contact in 3 o'clock position according to socket**

TANK CONTAINER

ISO Size Type Group Codes: 20KL, 22KL

20'

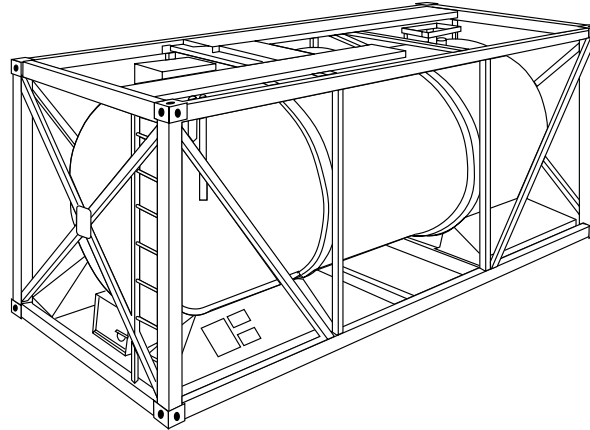

- Hapag-Lloyd can provide tank containers which are approved to the highest standards. Depending on the characteristics of the products to be carried, the requirements vary. Hapag-Lloyd offer their services on operational, technical and regulatory questions
- Separate tank fleets are available for:
 - FOODSTUFFS, e.g.:
 - Alcohols
 - Fruit juices
 - Edible oils
 - Food additives
 - CHEMICAL PRODUCTS, e.g.:
 - Flammables
 - Oxidising agents
 - Toxic substances
 - Corrosives

- Tanks must be filled to not less than 80 % of their capacity to avoid dangerous surge/swell during transport
- Tanks must not be filled to 100 % of their capacity. Sufficient ullage space shall be left – which must be determined depending on the thermal expansion of the product to be carried
- Certain dangerous products must be carried in tanks having no openings below the surface level of the liquid. Such tanks must be discharged through a syphon pipe by either pressure or pumping
- National road/rail weight limitations have to be maintained when arranging land transports
- For the cleaning of tanks and disposal of residues, dedicated rules apply

ESSENTIAL CONVERSION FACTORS

Multiple number of	by	to obtain equivalent number of
Inches/in	25.4	Millimetres/mm
Feet/ft	0.3048	Metres/m
Millimetres/mm	0.0394	Inches/in
Metres/m	3.281	Feet/ft
Sq. Metres/m ²	10.7639	Sq. Feet/ft ²
Sq. Feet/ft ²	0.0929	Sq. Metres/m ²
Cu. Feet/ft ³	0.0283	Cu. Metres/m ³
Cu. Metres/m ³	35.315	Cu. Feet/ft ³
Litres	0.0353	Cu. Feet/ft ³
Cu. Feet/ft ³	28.317	Litres
Litres	0.2642	U.S. Gallons
U.S. Gallons	3.785	Litres
Litres	0.22	U.K. Gallons
U.K. Gallons	4.5461	Litres
U.K. Gallons	1.2001	U.S. Gallons
U.S. Gallons	0.8327	U.K. Gallons
Kilograms/kg	2.2046	Pounds/lb
Pounds/lb	0.4536	Kilograms/kg
Long Tons (2240 lb)	1.01605	Tonnes (2204.62 lb)
Tonnes (1000 kg)	0.9842	Long Tons (1016.05 kg)
Bar	14.504	PSI
PSI	0.06895	Bar
Inches HG	0.4912	PSI
PSI	2.036	Inches HG
kg/sq. cm	14.223	PSI
PSI	0.0703	kg/sq. cm
kg/sq. cm	0.9807	Bar
Bar	1.02	kg/sq. cm
kg/sq. cm	28.976	Inches HG
Inches HG	0.0345	kg/sq. cm
Degrees Fahrenheit	5/9, after subtracting 32	Degrees Celsius (Centigrade)
Degrees Celsius (Centigrade)	9/5, and add 32	Degrees Fahrenheit

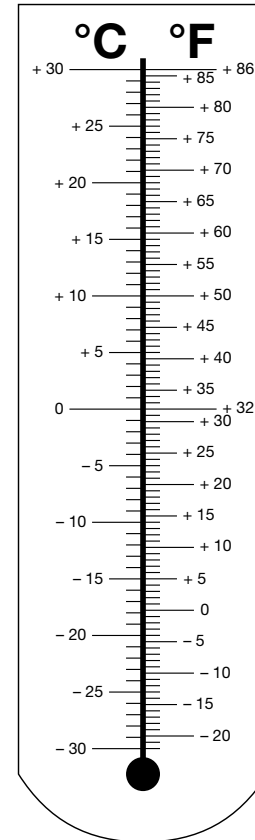

CONTAINER SIZE TYPE CODES ACCORDING TO ISO 6346

Size (L x H)	Type	ISO type group 1	ISO size type 2	ISO type group di* 1a	ISO size type di* 2a
20' x 8"	General Purpose	20GP	20G0		
20' x 8'6"	General Purpose	22GP	22G0		
		22GP	22G1		
20' x 8'6"	Bulk	22BU	22B0		
20' x 8'6"	Open Top	22UT	22U1		
20' x 8'6"	Hardtop	22UP *	22U6	22UT	22U6
20' x 1'11/4"	Platform	29PL	29P0		
20' x 8'	Flat (fixed ends)	20PF	20P1		
20' x 8'6"	Flat (fixed ends)	22PF	22P1		
20' x 8'6"	Flat (collapsible)	22PC	22P3		
20' x 8'6"	Refrigerated	22RT	22R1		
20' x 8'6"	Refrigerated (no foodstuffs)	22RC*	22R9*	22RT	22R1
40' x 8'6"	General Purpose	42GP	42G0		
		42GP	42G1		
40' x 9'6"	High Cube GP	45GP	45G0		
		45GP	45G1		

Size (L x H)	Type	ISO type group 1	ISO size type 2	ISO type group di* 1a	ISO size type di* 2a
40' x 8'6"	Open Top	42UT	42U1		
40' x 9'6"	High Cube Open Top	45UT	45U1		
40' x 8'6"	Hardtop	42UP *	42U6	42UT	42U6
40' x 9'6"	High Cube Hardtop	45UP *	45U6	45UT	45U6
40' x 2'	Platform	49PL	49P0		
40' x 8'6"	Flat (fixed ends)	42PF	42P1		
40' x 8'6"	Flat (collapsible)	42PC	42P3		
40' x 9'6"	Flat (collapsible)	45PC	45P3		
40' x 8'6"	Refrigerated	42RT	42R1		
40' x 8'6"	Refrigerated (diesel genset)	42RS	42R3		
40' x 8'6"	Refrigerated (no foodstuffs)	42RC *	42R9*	42RT	42R3
40' x 9'6"	Refrigerated	45RT	45R1		
40' x 9'6"	Refrigerated (no foodstuffs)	45RC *	45R9*	45RT	45R1
45' x 9'6"	High Cube Cont.	L5GP	L5G1		

*) Some types/groups in columns "1" and "2" are marked as non-ISO.
 "*" means ISO spares codes have been used. If official ISO codes required for data interchange (di), please use entries in columns "1a" and "2a".



Hapag-Lloyd

HLXU
45G1
iC
87

Disclaimer:

While we assume that the information and content provided by us is true and correct, it may, nevertheless, contain errors or inaccuracies. Hapag-Lloyd does not assume any liability for the accuracy of the information and content provided in the brochure, or for the consequences resulting from using the information and content provided in the brochure. Hapag-Lloyd does not guarantee or claim that said information and content is exhaustive. Claims as to the exhaustive nature of said information and content are excluded. The information and content is only provided for advertising purposes and is non-binding. No explicit or implied warranties or guarantees are made.

Company Headquarters

Hapag-Lloyd AG · Ballindamm 25 · Hamburg · Germany

Contact: Frank Nachbar · info@hapag-lloyd.com

www.hapag-lloyd.com