

Pre-Publication Copy

**Offshore Aquaculture  
in the United States:  
*Economic Considerations,  
Implications & Opportunities***

July 2008



**U.S. Department of Commerce  
National Oceanic & Atmospheric Administration  
Silver Spring, Maryland**

**You may download an electronic version of this report from:**

<http://aquaculture.noaa.gov>

**This document should be cited as follows:**

Offshore Aquaculture in the United States: Economic Considerations, Implications & Opportunities, July 2008 (Pre-Publication Copy)

**For more information:**

NOAA Aquaculture Program

1315 East-West Hwy.

SSMC #3 – Room 13117

Silver Spring MD 20910

(301) 713-9079

E-mail: [NOAA.Aquaculture@noaa.gov](mailto:NOAA.Aquaculture@noaa.gov)

Website: <http://aquaculture.noaa.gov>

**Pre-Publication Copy**

# **Offshore Aquaculture in the United States: Economic Considerations, Implications & Opportunities**

Prepared by the NOAA Aquaculture Program

From technical contributions by the editors and James L. Anderson, John Forster, Di Jin, James E. Kirkley, Gunnar Knapp, Colin E. Nash, Michael Rubino, Gina L. Shamshak, Diego Valderrama

NOAA Aquaculture Program  
1315 East-West Hwy.  
SSMC #3 - Room 13117  
Silver Spring MD 20910

July 2008

**U.S. DEPARTMENT OF COMMERCE**  
Carlos M. Gutierrez, Secretary

**NATIONAL OCEANIC & ATMOSPHERIC ADMINISTRATION**  
Vice Admiral Conrad C. Lautenbacher, Jr. USN (Ret.), Administrator

**NATIONAL MARINE FISHERIES SERVICE**  
James Balsiger, Acting Assistant Administrator for Fisheries

*This page intentionally left blank.*

# TABLE OF CONTENTS

---

Chapter 1: Introduction .....	1
<i>Michael Rubino</i>	
Chapter 2: Economic Potential for U.S. Offshore Aquaculture: An Analytical Approach .....	15
<i>Gunnar Knapp</i>	
Chapter 3: Emerging Technologies in Marine Aquaculture .....	51
<i>John Forster</i>	
Chapter 4: Future Aquaculture Feeds and Feed Costs: The Role of Fish Meal and Fish Oil .....	73
<i>Gina Shamshak &amp; James Anderson</i>	
Chapter 5: Lessons from the Development of the U.S. Broiler and Catfish Industries: Implications for Offshore Aquaculture in the United States .....	97
<i>Gina Shamshak &amp; James Anderson</i>	
Chapter 6: Economic Models of Potential U.S. Offshore Aquaculture Operations ...	117
<i>Di Jin</i>	
Chapter 7: The Potential Economic Ramifications of Offshore Aquaculture .....	141
<i>James Kirkley</i>	
Chapter 8: Potential Economic Impacts of U.S. Offshore Aquaculture .....	161
<i>Gunnar Knapp</i>	
Chapter 9: Interactions Between Capture Fisheries and Aquaculture .....	189
<i>Diego Valderrama &amp; James Anderson</i>	
Chapter 10: Current Status of Aquaculture in the United States.....	207
<i>John Forster &amp; Colin Nash</i>	
Chapter 11: Future Markets for Aquaculture Products .....	231
<i>James Anderson &amp; Gina Shamshak</i>	
Chapter 12: Broader Issues in the Offshore Fish Farming Debate .....	245
<i>John Forster</i>	
Background on the Authors .....	261

*This page intentionally left blank.*

# CHAPTER 1

## Introduction

Michael Rubino

---

Twenty years ago, offshore aquaculture – fish and shellfish farming in U.S. federal waters – was an emerging technology with tremendous potential. The United States and other countries were at the forefront of an engineering and technology revolution, much like the old race to the moon. Bit by bit, scientists, engineers, and researchers began to figure out the “how” for this type of aquaculture. They developed dependable cage systems, remote feeders, monitoring systems, and broodstock for species that would thrive in the open ocean environment. Every success fueled more interest. The potential for this type of seafood production was obvious – so were the challenges. Could this type of aquaculture be brought online safely as a way to complement wild harvest? Would it be economically viable? What about license to operate?

Today, aquaculture in federal waters is among the most talked-about technologies associated with the future of seafood production in the United States. This recent wave of interest in the offshore has strong roots in Chapter 24 of the U.S. Commission on Ocean Policy’s September 2004 report to Congress, *An Ocean Blueprint for the 21<sup>st</sup> Century*. In its report, the Commission recommended that the National Oceanic and Atmospheric Administration (NOAA) develop a comprehensive, environmentally sound permitting and regulatory program for marine aquaculture.<sup>1</sup>

In December 2004, the Administration responded to Commission recommendations with the *President’s Ocean Action Plan*. That plan specifically called for national legislation to allow aquaculture in U.S. federal waters. The Administration’s legislative proposal to establish a regulatory framework was submitted to Congress in 2005 and again in 2007. The latter proposal also calls for an expanded research program for all of U.S. marine aquaculture.

The introduction of national legislation for marine aquaculture garnered attention in the media and spawned a useful and ongoing national debate about the role of domestic aquaculture in America’s seafood supply. That debate centers around a host of marine management, economic, environmental, conservation, health, social, and regulatory issues. It also includes the eventual design of aquaculture regulations for federal waters and associated federal programs. As the agency at the center of the debate, and the one that would likely be tasked with developing and implementing any new federal regulations, NOAA commissioned a study group composed of fisheries resource economists and business experts to address key economic issues associated with offshore marine aquaculture. That effort resulted in this report, *Offshore Aquaculture in the United States: Economic Considerations, Implications & Opportunities*.

---

<sup>1</sup> Others making similar recommendations included an ad-hoc panel of the American Fisheries Society (Stickney et al. 2006), and the report of the Marine Aquaculture Task Force convened by the Pew Charitable Trusts and the Woods Hole Oceanographic Institute (Marine Aquaculture Task Force 2007).

Coordinated by the NOAA Aquaculture Program, the study group, which includes some of the leading natural resource and fisheries economists in the United States, was asked to examine:

- Trends and factors shaping aquaculture today;
- Forces that will drive it in the future;
- Inputs and outputs necessary to sustain its growth;
- Economic consequences of offshore aquaculture development in the United States; and
- Benefits and costs of such a domestic industry to the nation.

Specifically, the study considers:

- The effect on U.S. offshore aquaculture of global and national trends in seafood supply and demand and other factors that affect market prices, such as cost of feed and technology, social factors, government regulations, and access to sites.
- Useful models from other food segments of the U.S. economy, such as the catfish and poultry industries.
- Interactions between aquaculture and wild harvest fisheries.
- Economic analyses from the broadest to the narrowest scale.

The study also considers the broad, long-term implications of an established domestic offshore aquaculture industry in the United States and the role such an industry might play in helping to meet global demand for seafood, alternative energy, and other sustainable uses of the ocean. It is important to note that much of the analysis in this study, although limited to offshore aquaculture, applies to all U.S. aquaculture.

### **Study Caveats**

Several caveats should be noted up front:

1. Each chapter represents the efforts and views of its author(s) and not necessarily the views of other authors or of NOAA.
2. This study – as well as proposed offshore aquaculture legislation and NOAA’s Aquaculture Program – should be understood within the context of a broader federal initiative to address all aspects of marine aquaculture. In addition to offshore aquaculture, this broad federal initiative includes coastal shellfish farming, on-shore production methods, and hatcheries to produce stock for private fish and shellfish farms and for marine enhancement purposes.
3. Environmental concerns about all forms of aquaculture are the subject of much debate and widely differing views. And although it was not the purpose of this study to debate these issues, the links between environment and economics are discussed by several of the authors.
4. The study has specific geographical boundaries. Its focus concerns the potential of marine aquaculture in open ocean or offshore locations. It is necessary also to define the term “offshore,” because the jurisdiction of U.S. marine waters is unique. U.S. federal waters, also known as the Exclusive Economic Zone (EEZ), are the marine waters beyond the jurisdiction of



coastal states, out to a distance of 200 miles. In most cases, the regulatory control of the states extends to 3 miles offshore, but two states, Florida and Texas, claim jurisdiction out to 9 miles. For marine aquaculture technology, separation between federal and state waters is not important. The complication arises with how such waters are regulated. Under current U.S. law, aquaculture ventures may obtain a permit to operate in most state waters. The five offshore commercial operations and research projects in the United States – in Hawaii, Puerto Rico, California, and New Hampshire – are in state waters, in locations exposed to open ocean or offshore conditions. But the lack of clear regulatory requirements for aquaculture in federal waters has all but prohibited aquaculture in the U.S. EEZ (Cicin-Sain et. al. 2005). The National Offshore Aquaculture Act of 2007, currently pending before Congress, would clarify federal regulatory requirements, thus allowing businesses and individuals to obtain a permit to operate in federal waters.

5. The study is concerned exclusively with the contained cultivation of fish, shellfish, and marine plants for food or other commercial products. In other words, the study presumes control and ownership of the product under cultivation by the farmer who must, therefore, have a property right to the waters in which he farms.

6. The study specifically excludes consideration of marine aquaculture for enhancement of wild fisheries, such as the stocking of shellfish or finfish (e.g. oysters, salmon, and redfish). Although stock enhancement and commercial aquaculture are two uses of aquaculture hatchery techniques and products, the economic structure of stock enhancement directed by public agencies is quite different from private, commercial marine farming.

## **Background**

This is not the first time the United States has been urged to embrace marine aquaculture. In 1969, the Stratton Commission on Marine Science, Engineering and Resources published the seminal ocean policy report, *Our Nation and the Sea*.<sup>2</sup> That report had a profound influence over the next three decades on many marine activities, including aquaculture. It gave birth to NOAA as the nation's "Ocean's Agency," and was responsible for an immediate explosion of interest in sustainable uses of the sea and the protection of its ecosystems. It spawned ideas such as "farming the sea," and inspired the idea of a "Blue Revolution," comparing it to the "Green Revolution" in agriculture.

Perhaps the Stratton Commission recommendations were too ambitious. Marine aquaculture did not take off in the United States as it did elsewhere in the world. For many reasons, America's aquaculture industry, though vibrant and diverse, currently meets only 7.2% of our demand for seafood. Most of this is catfish. Marine aquaculture, largely in the form of oysters, clams, mussels, and salmon, supplies only about 1.5% of American seafood demand (NMFS 2007a). By contrast, in the past 30 years, aquaculture production in the rest of the world has expanded dramatically and now supplies almost half of world seafood demand (FAO 2006; Delgado et al. 2003). The upward trend is likely to continue. The United Nations Food and Agriculture Organization (FAO) estimated that an additional 40 million metric tons (mmt) of aquatic food will be required by 2030 over and above the 2005 worldwide consumption of 105.5

---

<sup>2</sup> <http://www.lib.noaa.gov/edocs/stratton/>

mmt (FAO 2006). FAO projects that most of this increase will be supplied by aquaculture. Few fisheries managers expect future increases in landings from commercial fisheries either in the United States or worldwide. So even if wild stocks are managed at sustainable levels, they will be unable to meet the increasing worldwide demand for seafood (Delgado et al. 2003; FAO 2006; The World Bank 2007).

Where have these developments left the United States? Globalization has profoundly affected U.S. seafood trade. We now import 80% of our seafood – 2.4 mmt or 5.4 billion pounds per year valued at \$13.4 billion in 2006 (NMFS 2007a). These imports, about half from aquaculture, were paid for with weaker U.S. dollars against a background of ever-increasing global seafood demand. We also export about half of our wild catch to markets in Asia and elsewhere. This global trade has affected which species Americans eat. Modest growth in per capita U.S. seafood consumption is occurring almost exclusively among aquaculture-based species. Seafood consumption figures for 2006 show that, since 1992, salmon is up 128%, shrimp is up 76%, and catfish is up 6%. The consumption of tilapia, now in demand throughout the country, was not even measured in 1992. In contrast, U.S. consumption of many traditional U.S. fish has fallen since 1992—cod is down 53%, clams are down 15%, tuna is down 17%, and flatfish dropped off the top-10 list of most consumed species. Only scallop consumption is up, just over 13%, since 1992.

Aquaculture not only increases the current seafood supply, but also reduces supply uncertainty and provides consumers a consistent, affordable product available year-round. In addition to consumers, some segments of the U.S. economy have participated in and benefited from the worldwide growth in aquaculture. U.S. companies, investors, and farmers have participated in the global aquaculture industry by exporting technology, equipment, seedstock, services, investment, feed, and grain. A significant, but undocumented, portion of U.S. seafood imports are linked to these exports.

In addition to supply and production trends, health and nutritional concerns are likely to affect seafood consumption in the United States. Doctors and nutritionists are urging Americans to eat more seafood to improve their health (Mozaffarian and Rimm, 2006; Institute of Medicine, 2006). But if Americans increase their seafood consumption from one to two meals per week, where will this seafood come from? Right now, we have a choice – we can continue to import increasing amounts of seafood, most of it from aquaculture, or grow some of it here.

Offshore aquaculture is one of the new frontiers for marine aquaculture production that could supply this growing demand. The others include raising marine species in closed systems (tanks), in ponds with low salinity water, and with new or improved methods of culturing seafood in coastal areas. All of these methods have their opportunities and challenges. Aquaculture is being pushed to offshore and land-based locations in the United States and elsewhere due to competition for uses of coastal waters, high coastal land values, and poor water quality in many coastal areas due to runoff from human activities on land (Cicin-Sain et. al. 2005).

As for the offshore, the U.S. EEZ is huge. It covers 3.5 million square miles or 9 million km<sup>2</sup>—20% more than U.S. lands—and spans Arctic to tropical marine habitats. Though not all

of the space in the EEZ can be used for aquaculture, conservative estimates show that less than 500 km<sup>2</sup> (less than 0.01% of the U.S. EEZ) would be enough to produce up to 600,000 metric tons or more of additional farmed seafood per year (Nash 2004). From the Atlantic and Caribbean to Alaska, the West Coast, Hawaii and the U.S. Trust Territories, this area spans a wide range of ocean conditions and habitats, making it feasible to farm an equally wide range of different aquatic species.

Culture of finfish, shellfish, and seaweeds in offshore waters is now technically feasible as shown by the dozens of commercial operations around the world using offshore aquaculture technologies. The United States is a leader in this type of aquaculture and in many related technologies. Currently, most of the emphasis worldwide is on the offshore farming of finfish because of market demand. However, shellfish, especially filter feeding bivalves such as mussels and scallops, can also be farmed offshore, as can seaweeds. Polyculture of finfish, shellfish, and algae in open ocean situations is also being pioneered in Canada, Spain, and elsewhere.

As in all new businesses, those who practice offshore aquaculture will learn by experience and will adapt through technical advances to the selective pressures of commerce and regulations. However, offshore aquaculture can only be established in the United States if operators are allowed to try it. Based on discussions at the 2007 National Marine Aquaculture Summit organized by NOAA, and discussions in other forums, investors and would-be investors in U.S. offshore aquaculture believe the biggest barriers to progress are the current lack of clear regulations to allow them access to needed marine waters and the certainty of operation,<sup>3</sup> Without clear rules:

- Entrepreneurs, fishermen, and others will not be allowed to try offshore aquaculture in the U.S. except in a few open ocean locations in state waters;
- U.S. investors and others will continue to set up offshore operations in other countries and may invest in other forms of aquaculture, such as land-based systems; and
- Americans may lose opportunities created by local production of seafood under U.S. laws.

U.S. investors are not waiting for the federal government to sort out its regulatory requirements. They are investing in offshore aquaculture in other areas, including the Caribbean and Latin America. Other countries such as Japan, Korea, Ireland, Norway, China, and Spain are working on offshore aquaculture technology and legal regimes (Lee and O'Bryen 2004; Ryan 2004).<sup>4</sup> In 2007, the European Union established an Offshore Aquaculture Technology Platform project with partners from 16 European Union countries and Norway.<sup>5</sup>

---

<sup>3</sup> See summary of National Marine Aquaculture Summit held in June 2007 in Washington, D.C. at <http://aquaculture.noaa.gov>.

<sup>4</sup> Also see conference program for Offshore Mariculture 2006 held in Malta, Oct 11-13, 2006 at [www.offshoremiculture.com/programme.cfm](http://www.offshoremiculture.com/programme.cfm).

<sup>5</sup> See [www.marine.ie/home/aboutus/newsroom/pressreleases/Offshore+Aquaculture+Workshop.htm](http://www.marine.ie/home/aboutus/newsroom/pressreleases/Offshore+Aquaculture+Workshop.htm) and [www.EATPnet.eu](http://www.EATPnet.eu)

## Opportunities and Challenges Considered in the Study

In examining the economic feasibility of U.S. offshore aquaculture, several authors highlight opportunities and challenges facing this new industry, including competitive advantages and disadvantages, economic viability and effects, competition between aquaculture and wild catch, and links between environmental and economic issues.

### Competitive Advantages and Disadvantages

The United States presents offshore aquaculture producers with a number of advantages:

- A huge area in which to farm (the U.S. EEZ).
- Well-developed coastal infrastructure.
- A strong home market.
- Excellent fresh and frozen food distribution systems.
- High-value niche markets for fresh, whole, live, eco-label, or certified products.
- An educated workforce and people with excellent animal husbandry skills.
- U.S.-produced feed ingredients.
- Strong property laws.
- Leading offshore aquaculture equipment designers and manufacturers.
- Strong research and extension capabilities.

To put these advantages to good use, however, U.S. offshore aquaculture producers must overcome several disadvantages or constraints, including the following:

- High coastal land values for tourism and housing competing for space for shore-side hatchery, landing, and processing facilities.
- Complex regulations in state waters and lack of clear regulations for federal waters.
- Competition from other uses of coastal and offshore waters, such as unobstructed views, recreational boating and fishing, commercial fishing, and shipping.
- Competition from low-cost imported seafood.
- High labor costs for processing of seafood products.
- Rising costs of inputs such as energy and feed.
- Concerns by fishermen about competition from aquaculture.
- Concerns about environmental effects of aquaculture.
- Technological and transport (distance from shore) challenges.

In examining competitive advantages and constraints, several of the authors looked at how the experience of the poultry and catfish industries may apply to offshore aquaculture. The U.S. broiler industry, the world's largest producer and exporter of poultry meat, is competitive because it is technically advanced and highly efficient, and has ready access to home-grown feed and raw materials. The growth of the freshwater catfish industry in the United States, and the catfish industry's recent difficulties due to rising feed costs and competition from imported catfish substitutes, also provide a model and lessons learned for a domestic offshore aquaculture industry.

*Economic Viability and Economic Effects*

Several authors show that offshore aquaculture can be economically viable and examine the potential economic effects of offshore aquaculture. For example:

- Spreadsheet or business models for offshore aquaculture projects based on technology now in use in New Hampshire, Hawaii, and Puerto Rico show that culture of finfish and mussels can be profitable under certain cost and revenue conditions.<sup>6</sup>
- An input output model predicts that full- and part-time jobs created across all sectors per thousand metric tons of production per year will number 102 for mussels, 261 for salmon, 475 for cod, and 683 for scallops (meats), increasing employment numbers reflecting higher selling prices for these products.<sup>7</sup>

The authors also note that a variety of Americans may benefit from offshore aquaculture, including the following:

- Consumers will benefit by having access to affordable, locally and regionally produced, safe, and healthy seafood. The seafood supply, marketing, and food service industries, including supermarkets and restaurants, will have access to additional U.S. supplies of seafood, thereby reducing supply risks.
- Aquaculture and wild capture fisheries are part of a spectrum of seafood production techniques with many synergies. Boat owners (including fishermen) will be owner operators or hired by offshore operations. Seafood processing waste is used in making fish feed. The whole seafood supply chain, from boats to docks to processing plants to cold storage, benefits from having predictable and increased throughput from aquaculture. Marine aquaculture may help keep working waterfronts alive.
- Finite supplies of fish meal and oil for fish feed may limit the expansion of aquaculture and has raised questions about aquaculture's environmental sustainability unless alternatives can be found (FAO 2006). But not only does the United States have its own fish meal and oil menhaden and sardine fisheries, its researchers are among the world leaders in development of alternatives, such as feeds from soybeans, algae, yeasts, and other products. Aquaculture is a growing market for the nation's farmers, some of whose crops can be used in aquaculture feeds. The United Soybean Board's Soy in Aquaculture Program is an example.<sup>8</sup> There are also fishery wastes from the abundant fisheries of Alaska that could be made into fish meal and oil if there were incentive to do so.
- American companies have pioneered and are leaders in the design of offshore containment systems, hatcheries, and alternative feeds. Global markets for their products and services beckon. A strong home market will reinforce their position.
- Research at U.S. hatcheries directed at commercial marine aquaculture (fingerling and spat production for grow-out on land or in nearshore or offshore facilities) will

---

<sup>6</sup> In addition to the firm level analyses in this report, see Hoagland, et al. 2004; Jin et al. 2005; Kam, et al. 2003; Lipton and Kim, 2007; and Forster 1996.

<sup>7</sup> For another look at the potential economic impacts of offshore aquaculture in the Gulf of Mexico see Posadas, 2004.

<sup>8</sup> <http://www.soyaqua.org>

benefit not only commercial aquaculture, but the beneficiaries of stock enhancement practices. U.S. hatcheries grow finfish and shellfish to enhance recreational and commercial fishing stocks and to restore endangered species and habitat.

### Competition between Aquaculture and Wild Catch

Several of the authors in this report consider the questions raised by competition and synergies with aquaculture.<sup>9</sup> The effect of increased U.S. aquaculture on U.S. wild caught fisheries will depend in part on whether new markets are created for increased U.S. aquaculture production, how fast and at what volumes new production comes to the market, whether new U.S. aquaculture production is a substitute for existing wild catch or imports, and whether U.S. fishermen participate in aquaculture production.

At the NOAA National Marine Aquaculture Summit in June 2007, and in other venues from the Gulf of Mexico to the Pacific Northwest, some commercial fishermen and others have expressed concern that aquaculture will hurt wild harvest in the United States. It is clear that aquaculture products, whether imported or domestic, compete with wild caught fisheries. They also compete with chicken, beef, and pork. Studies have also shown that global aquaculture production, notably of salmon and shrimp, contributed to reduced market prices for U.S. wild caught and farmed U.S. shrimp and for U.S. salmon caught from both wild and hatchery raised and released stocks (Knapp et al. 2007).

What is also clear – and often missing from the discussion of competition – is that competition will exist with or without domestic aquaculture. The marketplace is global and demand for seafood products is growing. The United States cannot meet consumer seafood demand through wild caught fishing activities alone. Seafood imports and other forms of protein, such as beef and chicken, already provide significant competition. Seafood business executives speaking at the National Marine Aquaculture Summit said that if seafood is not available from U.S. sources, their customers are demanding that they get it somewhere else (NMFS 2007b). The challenge therefore is to integrate aquaculture into domestic seafood production so that U.S. boat owners, fishermen, processors, and marketing companies can benefit directly.

### Environmental Issues

As noted among the caveats, environmental concerns with regard to aquaculture are the subject of much debate and widely differing views, and the links between environment and economics are discussed by several of the authors. These authors and others note that competitive pressures, innovation, and efficient regulations are pushing aquaculture toward best management or sustainable practices. The awareness of environmental constraints and issues is timely, and even essential for the aquaculture industry for several reasons:

- Climate change and the quality of ocean resources may directly affect the growing environment and resources available to aquaculture.
- The aquaculture industry may have no choice but to move to more efficient practices as feed, clean water, and energy are likely to become scarce or more expensive (see Food and Agriculture Organization, 2006, and The World Bank, 2007).

---

<sup>9</sup> Also see Kristofersson and Anderson, 2005; Anderson, 2002; and Barnaby and Adams, 2002.

- Application of designs and management practices termed sustainable, smart design, green, or eco-effective are a way to address some environmental issues (McDonough and Braungart, 1998 and 2002).
- Companies following these designs are likely to have access to high-value niche markets and shelf space at supermarkets and restaurants that require eco-certification of seafood products.

### **What Will Offshore Aquaculture Look Like in the United States?**

In this study, the authors present a framework for analyzing the economics of offshore aquaculture, preliminary results from economic models, and lessons learned from related sectors. Several of the authors show that offshore aquaculture can be economically viable under certain cost and revenue conditions. Viable operations will in turn create jobs from coastal communities to the country's farming heartland. The initial commercial finfish and mussels operations in open ocean locations in state waters have been successful enough to attract imitators and for additional investment to continue and expand their businesses. But their long-term success is by no means guaranteed. Current or future offshore aquaculture faces numerous economic and social challenges, as outlined in this report.

In my view, if offshore aquaculture proceeds in U.S. federal waters, various scales and regional approaches are likely to emerge. Right now, offshore aquaculture is still in its infancy. On top of that, U.S. aquaculture is diverse, and the regulatory structure for offshore aquaculture is still uncertain, so the technologies, species grown, cost structures, markets, and corporate structures of future offshore operations are still unknown. However, the pioneering offshore aquaculture ventures and research projects in U.S. state waters provide some indications of where the industry might be headed during the next decade.<sup>10</sup> For example:

- Cates International and Kona Blue Water Farms in Hawaii, and Snapperfarm in Puerto Rico, are pioneers of commercial open ocean finfish farming. They are selling product into high-value niche markets, they have demonstrated sufficiently positive results to attract additional investment from U.S. investors, and they are seeking to expand current operations. If the expansions are successful, these operations will be medium-sized commercial finfish operations, each producing about 500 to 1,000 metric tons of marine fish per year.
- A fisherman-owned and operated mussel farm off the coast of New Hampshire, Isle of Shoals Mussels, is using techniques pioneered by the University of New Hampshire's Atlantic Marine Aquaculture Center. The systems use floating submersible longlines anchored to the bottom (Fish Farming International, 2007). A similar private venture, Santa Barbara Mariculture, is located off the coast of California. Both operations harvested product and sold into commercial markets in 2007. The New Hampshire and Massachusetts Sea Grant programs also report interest from fishermen from Maine to Massachusetts who are considering this type of mussel farming.<sup>11</sup>

---

<sup>10</sup> For a review of U.S. projects see Barnaby 2006.

<sup>11</sup> Roland Barnaby and Richard Langan, 2008, personal communications.

- Great Bay Aquaculture in New Hampshire, one of the principal commercial suppliers of fingerlings to the marine aquaculture industry and research institutions, is producing species that are or could be used in offshore aquaculture, such as cobia and cod.

Offshore aquaculture is likely to undergo changes if it is permitted to move forward in the U.S. For example, if a regulatory framework is put in place, we might expect 10 years of experimentation and different approaches similar to the operations already in place in state waters. Total production is likely to be modest, with sales focused on niche markets (such as live, fresh, and certified markets). If one or more approaches are successful, rapid expansion could occur in the second decade. This has been the pattern in other aquaculture sectors around the world.

Niche market production will not supply the large quantities needed by supermarkets, restaurant chains, and the food service industry that depend on commodity products. While larger volumes have been supplied by many small operations in some parts of Asia, larger volume production in the United States is more likely to be supplied by vertically integrated operations similar to salmon, sea bass, and sea bream operations in Europe, Canada, and Chile.

The type of ownership and structure of small and large offshore operations in the United States also remains to be seen. All five of the small U.S. commercial offshore finfish and mussel operations were started by U.S. citizens active in commercial fishing and seafood businesses. Future participants in offshore aquaculture may include U.S. and foreign corporations and fishermen's cooperatives, as have been formed in Italy and Japan (Barnaby and Adams 2002) or similar combinations.

As noted in the 2007 *NOAA 10-Year Plan for Marine Aquaculture*, the United States stands at a critical juncture in the development and implementation of marine aquaculture in our nation. Future demands for healthy, safe, and local seafood will require many forms of aquaculture. Offshore aquaculture can be an important component of future domestic marine aquaculture if a regulatory framework is put in place and if offshore production proves to be financially sustainable. This report raises and discusses key questions about the economic viability and effects of offshore aquaculture. NOAA and others will continue to examine these issues and, as questions are raised, analyzed, and discussed, the answers will determine what U.S. marine aquaculture looks like 10 and 20 years from now.

## References

- Anderson, J.L. 2002. Aquaculture and the Future: Why Fisheries Economists Should Care. *Marine Resource Economics* 17:133-151.
- Barnaby, R. and S. Adams. 2002. Aquaculture: Opportunity or Threat to Traditional Capture Fishermen? *Fish Farmer* 24(2):71-78.
- Barnaby, R. 2006. Growing Seafood in the Open Ocean. New Hampshire Sea Grant Technical Report. Durham, NH.



Cicin-Sain, B., et. al. 2005. An Operational Framework for Offshore Marine Aquaculture in U.S. Federal Waters. Technical Report. Center for Marine Policy, University of Delaware.

Delgado, C.L., N.Wada, M.W. Rosegrant, S.Meijer, and M.Ahmed. 2003. Fish to 2020: Supply and Demand in Changing Markets. International Food Policy Research Institute, Washington, D.C. Available at <http://www.ifpri.org/pubs/books/fish2020book.htm>

Fish Farming International. 2007. Offshore Mussel Farm is USA First. *Fish Farming International*, November 2007, p.7.

Food and Agriculture Organization of the United Nations. 2006. *State of World Aquaculture*. FAO Fisheries Technical Paper 500.

Forster, J. 1996. Cost and Market Realities in Open Water Aquaculture. In Polk, M. (ed.) Open Ocean Aquaculture: Proceedings of an international conference. Portland, ME. New Hampshire/Maine Sea Grant College Program. Report # UNHMP-CP-SG-96-9: 137-149.

Hoagland, P., H.L. Kite-Powell, and D. Jin. 2004. Business Planning handbook for the Ocean Aquaculture of Blue Mussels. Marine Policy Center. Woods Hole Oceanographic Institute, Woods Hole, MA.

Institute of Medicine of the National Academies. 2006. *Seafood Choices: Balancing Benefits and Risks*. National Academies Press, Washington, D.C.

Jin, D., H. Kite-Powell, and P. Hoagland. 2005. Risk Assessment in Open-Ocean Aquaculture: A Firm-Level Investment-Production Model. *Aquaculture Economics and Management* 9:369-387.

Kam, L.E., P. Leung, and A.C. Ostrowski. 2003. Economics of Offshore Aquaculture of Pacific Threadfin (*Polydactylus sexfilis*) in Hawaii. *Aquaculture* 223(2):63-87.

Knapp, G., C.A. Roheim, and J.L. Anderson. 2007. The Great Salmon Run: Competition Between Wild and Farmed Salmon. TRAFFIC North America. World Wildlife Fund, Washington, D.C.

Kristofersson, D. and J.L. Anderson. 2005. Is There a Relationship Between Fisheries and Farming? Interdependence of Fisheries, Animal Production, and Aquaculture. *Marine Policy* 30: 721-725.

Lee, C. and P.J. O'Bryen. 2007. *Open Ocean Aquaculture: Moving Forward*. Oceanic Institute, Waimanalo, Hawaii.

Lipton, D.W. and D.H. Kim. 2007. Assessing the Economic Viability of Offshore Aquaculture in Korea: An Evaluation based on Rock Bream, *Oplegnathus fasciatus*, Production. *Journal of the World Aquaculture Society* 38(4):506-515.

Marine Aquaculture Task Force. 2007. Sustainable Marine Aquaculture: Fulfilling the Promise; Managing the Risks. Takoma Park, MD. Available at [http://www.pewtrusts.org/uploadedFiles/wwwpewtrustsorg/Reports/Protecting\\_ocean\\_life/Sustainable\\_Marine\\_Aquaculture\\_final\\_1\\_07.pdf](http://www.pewtrusts.org/uploadedFiles/wwwpewtrustsorg/Reports/Protecting_ocean_life/Sustainable_Marine_Aquaculture_final_1_07.pdf)

McDonough, W. and M. Braungart. 1998. The NEXT Industrial Revolution. *The Atlantic Monthly* 282(4):82-92.

McDonough, W. and M. Braungart. 2002. *Cradle to Cradle: Remaking the Way We Make Things*. North Point Press, New York.

Mozaffarian, D. and E.B. Rimm. 2006. Fish Intake, Contaminants, and Human Health. *Journal of the American Medical Association* 296(15):1885-1899.

Nash, C.E. 2004. Achieving Policy Objectives to Increase the Value of the Seafood Industry in the United States: The Technical Feasibility and Associated Constraints. *Food Policy* 29:621-641.

National Marine Fisheries Service (NMFS). 2007a. *Fisheries of the United States 2006*. U.S. Department of Commerce, National Oceanic and Atmospheric Administration, NMFS, Office of Science and Technology, Fisheries Statistics Division. Also see [http://www.nmfs.noaa.gov/fishwatch/trade\\_and\\_aquaculture.htm](http://www.nmfs.noaa.gov/fishwatch/trade_and_aquaculture.htm)

National Marine Fisheries Service (NMFS). 2007b. Summary of the National Marine Aquaculture Summit. Available at [http://aquaculture2007.noaa.gov/pdf/summitsum\\_web\\_1\\_08.pdf](http://aquaculture2007.noaa.gov/pdf/summitsum_web_1_08.pdf)

National Oceanic and Atmospheric Administration. 2007. NOAA 10 Year Plan for Marine Aquaculture. U.S. Department of Commerce, National Oceanic and Atmospheric Administration. Available at <http://aquaculture.noaa.gov>

Posadas, B.C. 2004. Potential Economic Impact of Commercial Offshore Aquaculture in the Gulf of Mexico. Mississippi-Alabama Sea Grant publication MASGP 04-036.

Rubino, M.C. 2007. Remarks: Keynote for Symposium on Environmental Impacts of Coastal Ocean Aquaculture, American Fisheries Society Meeting, San Francisco, CA, September 5, 2007. Available at [http://aquaculture.noaa.gov/pdf/afs\\_07\\_rubino.pdf](http://aquaculture.noaa.gov/pdf/afs_07_rubino.pdf)

Rubino, M.C. 2007. At the Crossroads: A Perspective on the Future of US Aquaculture. *Fish Farming News* 6:14-16.

Ryan, J. 2004. Farming the Deep Blue. Irish Sea Fisheries Board and Irish Marine Institute.

Stickney et al. 2006. Toward Sustainable Open Ocean Aquaculture in the United States. *Fisheries* 31:583-610.

The World Bank. 2007. *Changing the Face of the Waters: The Promise and Challenge of Sustainable Aquaculture*. The World Bank, Washington, D.C.

*This page intentionally left blank.*

## CHAPTER 2

# Economic Potential for U.S. Offshore Aquaculture: An Analytical Approach

Gunnar Knapp

---

*This chapter presents an analytical approach for thinking about the economic potential for offshore aquaculture in the U.S. We review basic economics of aquaculture and discuss major factors which might affect the costs, prices, profitability, and competitiveness of such an industry.*

### Introduction

Our purpose is not to analyze the economic viability of any of the numerous, potential types of domestic offshore fish farming. The costs, prices, and economic viability of offshore fish farms may vary widely depending on species, location, technology, scale, and regulations. Rather, this chapter suggests a way of thinking about the economic viability of U.S. offshore fish farming in a logical and systematic manner. The discussion focuses mainly on offshore finfish farming rather than offshore shellfish farming, although many of the considerations in assessing economic potential are similar for both types of offshore aquaculture.

#### Box 2.1. Definitions for Selected Terminology Used in this Chapter.

Offshore aquaculture. Aquaculture in exposed ocean waters. As used in this chapter, offshore aquaculture does not necessarily mean aquaculture in federal waters.

Inshore aquaculture. Marine aquaculture in inshore waters (all marine aquaculture other than offshore aquaculture).

Type of offshore aquaculture. Farming of a particular species using a particular kind of technology.

Fish farm. An aquaculture operation (including both finfish and shellfish).

Economic viability. Whether or not a particular type of fish farming is likely to be profitable.

Economic potential. The scale at which a particular type of fish farming is likely to be economically viable, as measured (for example) in aggregate annual production.

We begin by discussing three major challenges in assessing the economic potential for U.S. offshore aquaculture. These are: 1) the limited experience to date with offshore aquaculture and the likelihood of continued change in key factors affecting economic potential, including technology, feed costs, and markets; 2) the diversity of potential types of offshore aquaculture; and, 3) the importance of the regulatory regime in affecting economic potential.

We next present a theoretical framework for thinking about the potential economic viability and economic potential of U.S. offshore aquaculture, using elementary supply and demand analysis. The main purpose of this discussion is to show that the economic viability of U.S. offshore fish farms depends on both supply and demand conditions both for U.S. offshore

fish farms and for all other competing sources of supply. What matters is not whether competitors can produce fish at a lower cost, but whether they can produce enough fish at a lower cost to keep prices below levels at which U.S. offshore farming is profitable. The economic viability of U.S. offshore fish farming may change over time, in response to changes in the costs of conducting business, changes in competitors' costs, or changes in demand.

Next discussed are the basic economics of aquaculture: the major factors affecting fish farming costs and prices. We discuss four broad types of costs: facilities cost, feed cost, juveniles cost, and other operating costs, as well as the major factors that affect these costs.

We next consider the potential competitiveness of U.S. offshore fish farms: reasons for which their costs and prices might be higher or lower than those of competitors supplying the same markets. We first discuss the competitiveness of offshore farming relative to inshore farming, and then the competitiveness of United States offshore farming relative to offshore farming in other countries.

We then briefly discuss how economic modeling may be used to examine the economic viability of a fish farm. For purposes of illustration, we present a simple economic model of a hypothetical offshore fish farm raising a hypothetical fish species.

We conclude by considering the limits of economic studies for assessing potential long-term economic viability of industries with rapidly evolving markets and technology. It is suggested that the ultimate test of the economic viability of U.S. offshore aquaculture is the market. Without an enabling regulatory framework, such a test cannot happen and U.S. offshore aquaculture will not develop.

Finally, general observations are made about the economic potential for U.S. offshore aquaculture.

### **Challenges in Assessing the Economic Potential for U.S. Offshore Aquaculture**

There are several fundamental challenges in assessing the economic potential for U.S. offshore aquaculture.

A first challenge is that the world offshore aquaculture industry is still in its infancy. In both the United States and other countries, there has been very limited experience with offshore aquaculture. As we discuss below, the economic potential for offshore aquaculture is likely to grow over time, for reasons including growing world demand for fish; growing demand for land, fresh water, and inshore waters for uses other than agriculture and aquaculture; and improvements in offshore aquaculture technologies. But we do not know how rapidly these changes may occur or what their cumulative effects might be. The farther we look into the future, the less certain we can be about the key factors which affect the economic potential for U.S. offshore aquaculture: what aquaculture technologies may evolve, what the resulting cost structures may be for onshore and offshore aquaculture, what prices of fish and other competing proteins will be, and how costs and prices for U.S. offshore fish farms may vary from those of competing nations.

A second challenge is that potential U. S. offshore aquaculture is very diverse. The United States has a very large exclusive economic zone with waters ranging from arctic to tropical. There are many different species which could be farmed in the U.S. EEZ, using many different types of technologies. Thus, there is not a single answer about the economic potential for U.S. offshore aquaculture. Rather, there are many answers for different regions, species, and technologies.

A third challenge is that the economic potential for U.S. offshore aquaculture depends critically on how it is regulated. How offshore aquaculture is regulated will directly affect where it may be developed, the species which may be farmed, the scale of projects which may be developed, the technologies which may be used, and costs such as environmental monitoring and taxes. How offshore aquaculture is regulated will also directly affect how long it takes for projects to be permitted and developed and the costs and risks associated with regulatory uncertainty and legal challenges. Thus, part of the answer to the question “what kind of offshore aquaculture could we have?” depends upon the answer to the question, “what kind of offshore aquaculture do we want?”

For all of these reasons, this chapter offers no definitive conclusions about the economic potential for specific types of U.S. offshore aquaculture. Rather, it frames a way of looking at the issues and suggests some tentative and general conclusions.

### **Economic Potential for U.S. Offshore Aquaculture: Insights from Supply and Demand Analysis**

Supply and demand analysis provides a useful starting point for thinking about factors affecting the economic potential for U.S. offshore aquaculture. Here, we use supply and demand analysis to examine how potential competition from U.S. inshore farms<sup>1</sup>, foreign farms, and wild fisheries might affect the economic potential for U.S. offshore farms.

For the purposes of this discussion, all of the supply and demand curves are given for fish of the same species.<sup>2</sup> For different real-world species, the supply and demand curves would have different shapes—with different implications for economic potential.

As we discuss in greater detail later in this chapter, each existing or potential farming operation for a particular species has a cost of production per pound. This cost may be expressed as the sum of costs per pound for facilities, feed, juveniles, and other operating costs.<sup>3</sup> These costs may vary between farms depending on their location, type of technology, scale of the operation, and the costs of various factor inputs (labor, energy, etc.). A farm is economically

---

<sup>1</sup> We use the term “inshore farms” to refer to marine aquaculture operations that are not “offshore”—in other words, farms in protected waters with limited exposure. For purposes of this discussion, we exaggerate the distinction between “inshore” and “offshore farming.” In reality, there is a continuum between “inshore” and “offshore” farming, as farming occurs in waters of progressively greater depth, exposure, and distance from shore.

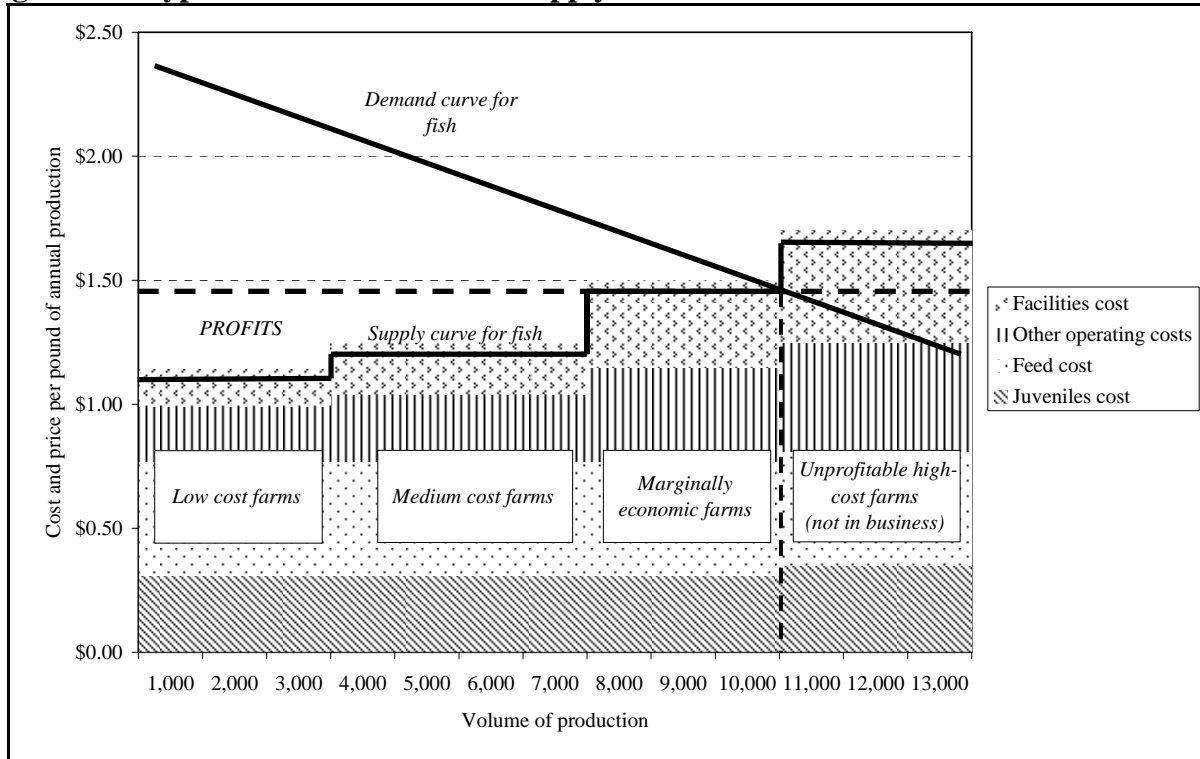
<sup>2</sup> Alternatively, they could be viewed as being for multiple species which are close market substitutes.

<sup>3</sup> By “facilities cost per pound” we refer to the cost per pound of multi-year investments in pens, vessels, and other facilities, expressed on an equivalent annual cost per-pound basis, and including a rate of return equal to the risk-adjusted opportunity cost of capital.

viable if and only if the price it receives per pound is greater than or equal to the total cost of production per pound (including the risk adjusted cost of capital).

As illustrated in Figure 2.1, we may plot the costs of all existing and potential fish farms for a particular species on a graph, with costs per pound on the vertical axis, and annual production on the horizontal axis arranged in ascending order of cost per pound. Plotted in this way, the total costs per pound form a supply curve for the species: the horizontal axis shows the volume of fish production that is economically viable at any given price per pound.

**Figure 2.1. Hypothetical short-run fish supply and demand curves.**



We may also plot a demand curve in the same figure, showing the volume of fish that is demanded at any given price. In the example shown in Figure 2.1, the demand curve and the supply curve determine the equilibrium price (\$1.50/lb) and aggregate production (10,000 metric tons).

Note that in this example, low-cost farms and medium-cost farms are earning profits. The marginally economic farms are earning zero profits and are just able to stay in business. Unprofitable high-cost farms are not in business.

This simple figure illustrates a basic but important point in considering the economic potential for offshore aquaculture. It is possible for a fish farm to be economically viable even if other farms have lower costs, as long as the total supply from lower-cost farms remains limited. What matters for the economic viability of offshore aquaculture is not whether some competitors can produce fish at a lower cost, but whether they can produce enough fish at a lower cost to hold down the price below levels at which U.S. offshore aquaculture production is profitable.



We may use this supply and demand framework to discuss factors affecting the ability of U.S. offshore aquaculture to compete with three potentially lower-cost competitors: 1) domestic inshore aquaculture; 2) foreign aquaculture; and 3) wild fisheries.

### Competitiveness of U.S. Offshore Aquaculture with U.S. Inshore Aquaculture

Considering first U.S. inshore aquaculture, for purposes of illustration we make two simple assumptions about the shape of the U.S. marine aquaculture supply curve:

- As aquaculture production moves offshore, from sites with relatively low exposure to sites of moderate and high exposure, costs of production increase.
- There are a limited number of potential farming sites with low exposure; there are more sites with moderate exposure; and there are a great number of sites with high exposure.

Given these assumptions, we might expect the supply curve for U.S. marine aquaculture to look something like that shown in Figure 2.2. Costs of production are relatively low for a limited number of inshore sites with low exposure to waves and wind. As farming expands to the limited number of sites with moderate exposure, costs of production increase. As farming expands to offshore areas with high exposure, costs increase further and the supply curve flattens out because of the very large offshore area potentially available for farming.<sup>4</sup>

**Figure 2.2. Hypothetical U.S. marine aquaculture supply curve.**

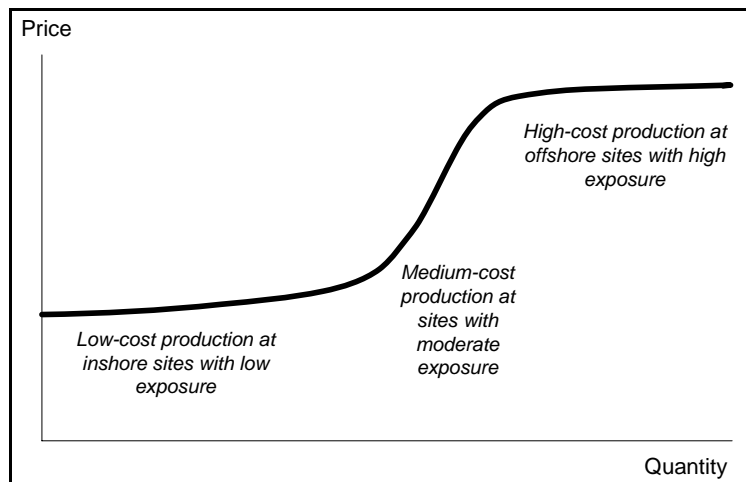


Figure 2.3 illustrates a domestic situation in which offshore aquaculture would *not* be economically viable because of competition from inshore aquaculture. The demand curve for fish intersects the supply curve at an equilibrium quantity,  $Q$ , which can be met by lower-cost

<sup>4</sup> It is not necessary to assume that the supply curve has the shape shown in the figure. The only essential assumptions for this discussion are that the supply curve is upward sloping, and that offshore farms have higher costs and become economically viable only at higher prices. It could be argued that the supply curve should not “flatten out” even as production reaches offshore sites with high exposure, because the costs of other inputs, such as feed and juveniles, would continue to increase as production increases.

inshore farms. The equilibrium price,  $P$ , is too low for offshore farms to be profitable. Thus, offshore farming will not be economically viable if lower-cost inshore farms can fully meet demand at prices below the cost of offshore farming.

**Figure 2.3. Demand and supply conditions in which offshore farming is not economically viable because lower-cost inshore sites can meet demand.**

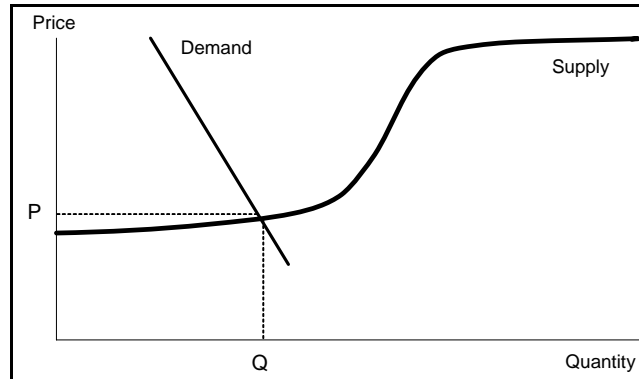


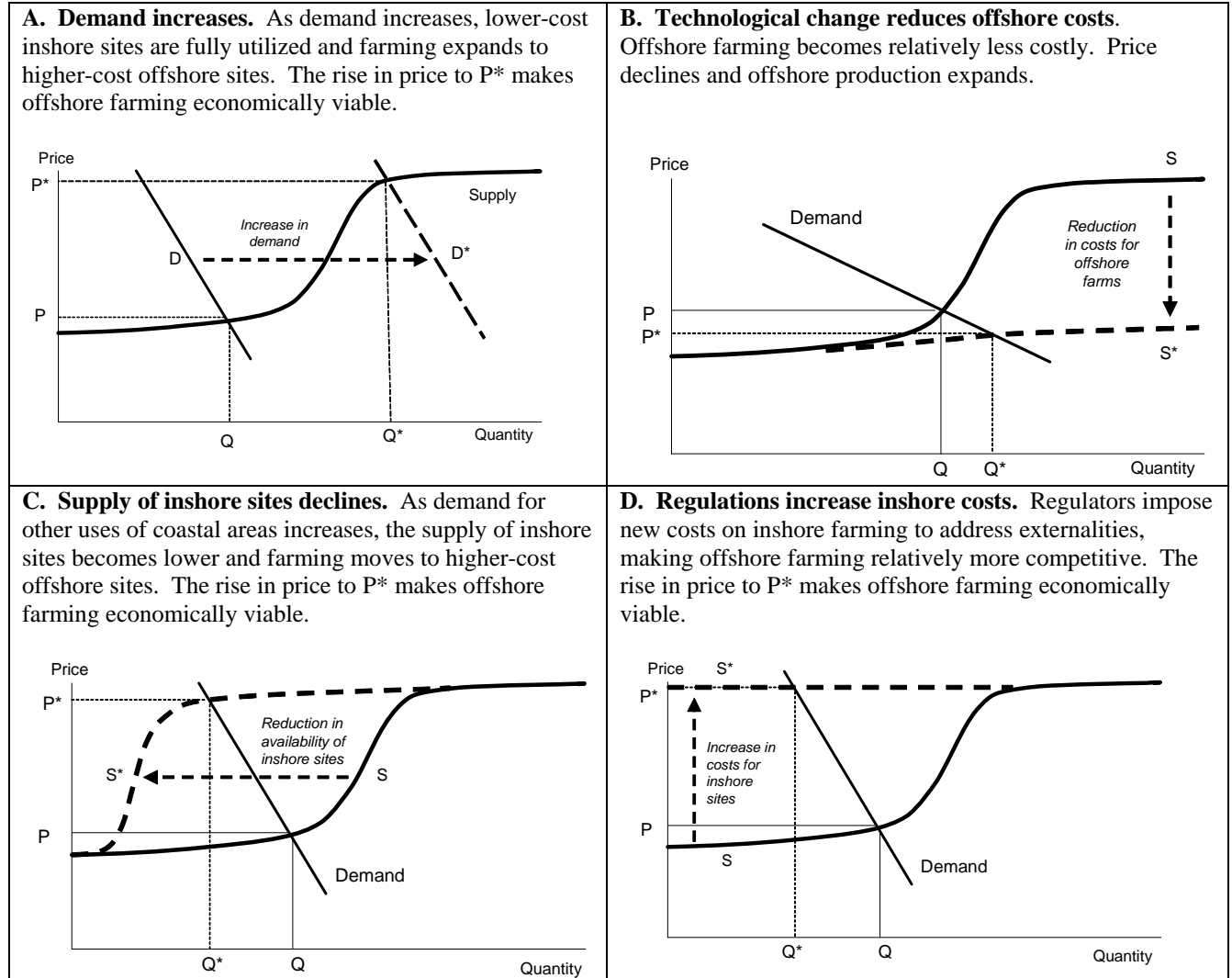
Figure 2.4 illustrates four ways in which demand or supply conditions could change from those in Figure 2.3 so that offshore aquaculture would become competitive with inshore aquaculture:

- Higher-cost offshore farms can compete with lower-cost inshore farms if demand exceeds the volume that can be produced from lower-cost, inshore sites (Figure 2.4A).
- Offshore farms can compete with inshore farms if costs for offshore farming decline sufficiently to become competitive with inshore farming (Figure 2.4B).
- Offshore farms can compete with inshore farms if the availability of inshore sites declines so that inshore farms are no longer able to meet demand (Figure 2.4C).
- Offshore farms can compete with inshore farms if the cost of inshore farms increases so that offshore farms are competitive with inshore farming (Figure 2.4D).

Note that two of the situations illustrated by Figure 2.4 have nothing to do with the relative costs of inshore and offshore fish farming. Even if inshore farming incurs lower costs, offshore farming can successfully compete with inshore farming if demand increases sufficiently or if the number of inshore sites declines sufficiently.

Some kinds of fish farming may impose externalities—additional costs to society not paid by farmers—such as wastes, navigational obstacles, or visual impacts. As discussed in other chapters of this report, some of these externalities may decline as aquaculture moves offshore. For example, an offshore farm may have less of a visual impact and may have less of an impact on water quality than an inshore farm.

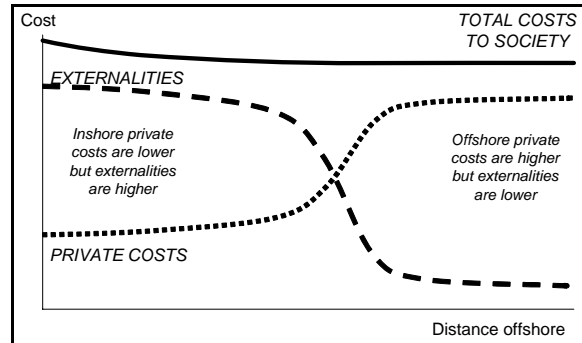
**Figure 2.4. How offshore aquaculture could become competitive with inshore aquaculture.**



In theory, as illustrated in Figure 2.5, if externalities decline sufficiently as farms move offshore, then even if the private costs of offshore farming are higher than those of inshore farming, the total costs to society could be less. If this were the case, then increasing the costs of inshore farming to “internalize the externalities”—for example, through taxes—could make offshore farming economically viable. (This scenario was illustrated by Figure 2.4D)

**Figure 2.5. Hypothetical fish farming private costs and externalities.**

If externalities decline as farming moves offshore, total costs to society could be lower for offshore farms.



**Competitiveness of U.S. Offshore Aquaculture with Foreign Offshore Aquaculture**

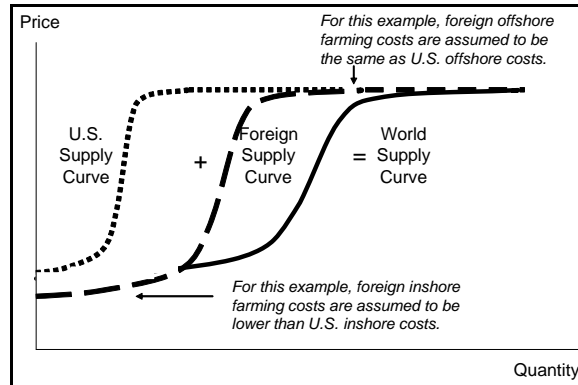
Considering next the competition from foreign aquaculture, we assume for purposes of discussion that for some kinds of foreign aquaculture—inshore, offshore, or both—costs are lower than those in the United States. Lower costs could result from a variety of factors, such as reduced labor costs, government subsidies, or less stringent environmental regulation or enforcement.

One potential situation is illustrated in Figure 2.6, in which we have assumed that foreign costs are lower than domestic costs for inshore aquaculture, but that the costs of foreign offshore aquaculture would be the same as those in the United States. We have drawn the supply curve for foreign aquaculture as similar in shape to that for U.S. aquaculture, but farther to the right, because for any given price, foreign producers are able to supply a greater volume than U.S. producers. The world supply curve—which shows the total volume supplied to world markets for any given world price—is the horizontal sum of the United States and foreign demand curves.

Figure 2.7 illustrates two situations in which U.S. offshore aquaculture would *not* be economically viable because of competition from foreign aquaculture. In Figure 2.7A, the demand curve for fish intersects the supply curve at an equilibrium quantity, *Q*, which can be met by lower-cost, foreign inshore farms. The equilibrium price, *P*, is too low for either U.S. or foreign offshore farms to be profitable.

In Figure 2.7B, foreign offshore farms exhibit lower costs than U.S. farms. Although demand is high enough for foreign offshore farms to be profitable, the world price is too low for U.S. offshore farms to be profitable (although it is high enough for U.S. farms on sites with moderate exposure to be profitable).

**Figure 2.6. Hypothetical U.S., foreign, and world marine aquaculture supply curves.**



U.S. offshore farms will not be competitive if they have to match prices for lower-cost foreign inshore or offshore farms, and those farms can satisfy world demand at prices less than the cost of U.S. offshore farms.

**Figure 2.7. Situations in which U.S. offshore aquaculture would not be economically viable because of competition from foreign aquaculture.**

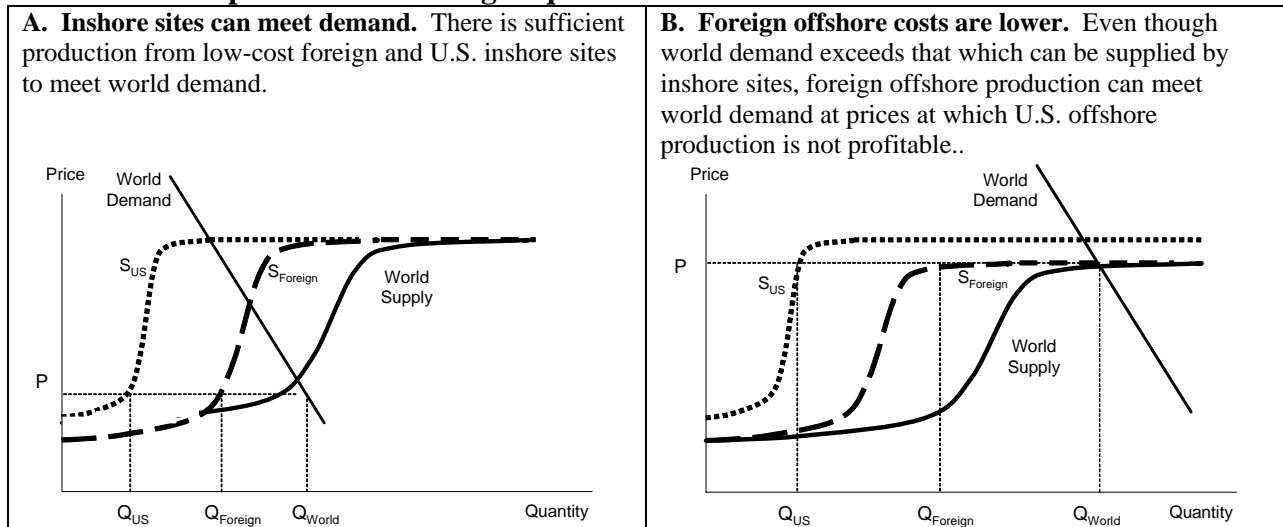
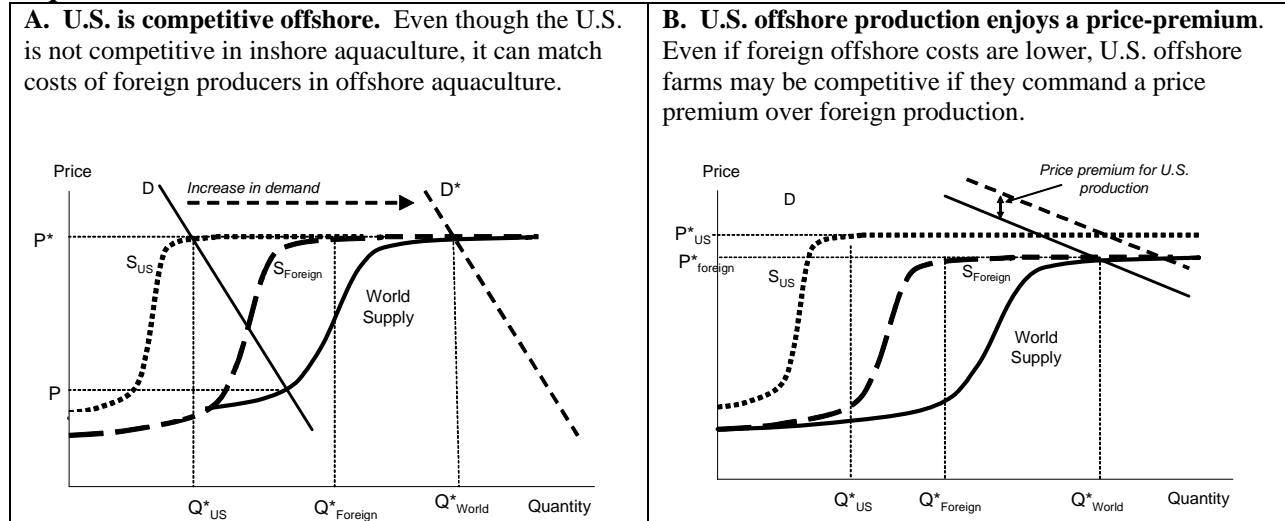


Figure 2.8 illustrates two ways in which demand or supply conditions could change so that U.S. offshore farming could become competitive with foreign farms.

- U.S. offshore farms can compete with lower-cost foreign inshore farms if their costs are similar to foreign offshore costs, and if demand expands sufficiently so that lower-cost U.S. and foreign inshore sites are fully utilized, causing prices to increase to levels at which U.S. offshore farming is profitable (Figure 2.8A).
- U.S. offshore farms can compete with lower-cost foreign inshore or offshore farms if U.S. offshore farms are able to command a price premium over the world market price; for example, due to lower costs of transport to the U.S. market or perceived higher quality (Figure 2.8B).

**Figure 2.8. How U.S. offshore aquaculture could become competitive with foreign aquaculture.**



### Competitiveness of U.S. Offshore Aquaculture with Wild Fisheries

Considering, finally, competition from wild fisheries, this could be modeled similarly to the way we have modeled competition between U.S. offshore aquaculture and foreign aquaculture. (To avoid repetition, these supply and demand curves have been omitted.) A key difference is that total supply from wild fisheries is limited by nature. Thus, the supply curve becomes steeper and, ultimately, vertical as production increases.

Following the same reasoning as discussed above, U.S. offshore farms cannot compete with wild fisheries if they have to match prices for lower-cost wild fisheries and if wild fisheries can satisfy world demand at prices below the costs of U.S. offshore farms. However, U.S. offshore farms can compete with wild fisheries if wild fisheries cannot fully satisfy world demand, allowing prices to rise to levels at which U.S. offshore farms are profitable—or if U.S. offshore farms can command a sufficient price premium over lower-cost, wild fisheries.

### An Algebraic Restatement

We may make the same points about the potential competitiveness of higher-cost offshore aquaculture in a different way using simple algebra and the following definitions:

Offshore cost	=	Cost per pound for offshore farms
Competitor cost	=	Cost per pound for competitors of offshore farms
Offshore price	=	Price paid for fish produced by offshore farms
Competitor price	=	Price paid for fish produced by competitors of offshore farms
Competitor profitability	=	Competitor price – Competitor cost
Offshore cost premium	=	Offshore cost – Competitor cost
Offshore price premium	=	Offshore price – Competitor price

Offshore farming will be viable if:

$$\text{Offshore cost} < \text{Offshore price}$$

Subtracting “competitor cost” from both sides of this equation, and subtracting and adding “competitor price” on the right-hand side of the equation, we may rewrite this condition as:

$$(Offshore\ cost - Competitor\ cost) < (Offshore\ price - Competitor\ price) + (Competitor\ price - Competitor\ cost)$$

Simplifying, we may restate the condition for higher-cost offshore farming to be profitable as:

$$Offshore\ cost\ premium < Offshore\ price\ premium + Competitor\ profitability$$

Thus, higher-cost offshore farming can be viable as long as the difference in costs is less than the sum of any offshore price premium (if there is one) and lower-cost competitors’ profits. Put differently, if lower-cost competitors are earning sufficiently high profits, higher-cost offshore farms may be profitable at the same prices or, especially, if they are able to command a premium price.

### **Summary of Insights from Supply and Demand Analysis**

U.S. offshore fish farms may be economically viable even if other farms have lower costs, as long as the total supply from lower-cost farms is limited. What matters is not whether competitors can produce fish at a lower cost, but whether they can produce enough fish at a lower cost to keep prices below levels at which U.S. offshore farming is profitable.

For any given fish species, the economic viability of U.S. offshore fish farms depends on far more than the relative cost of U.S. offshore farming in comparison with other sources of world fish supply. Note that farming—rice, wheat, poultry, beef—occurs worldwide in countries and environments with vastly different costs of production, not just in the lowest-cost countries and environments.

Neither prices nor costs for U.S. offshore aquaculture or its potential competitors are fixed. Prices and costs may change over time, and as a result, the economic viability of different types of offshore aquaculture may change over time. The economic potential for U.S. offshore aquaculture will also respond to changes in either world demand or changes in world supply from any source.

### **Basic Economics of Aquaculture**

We next discuss basic economics of aquaculture. We focus on factors important for considering the potential economic viability of a farm and the relative competitiveness of offshore farming. For purposes of this discussion, we simplify the analysis by expressing all costs and revenues on a per-pound basis. This requires converting all costs and revenues—including one-time investment costs—into costs and prices per pound. The appendix to this chapter explains how this may be done so that costs per pound are comparable to prices per pound.<sup>5</sup>

---

<sup>5</sup> As discussed in the appendix, a fish farm incurs costs and receives revenues over time. Prior to earning any revenues, a fish farm incurs initial one-time costs of planning, permitting, and capital investments for cages and other facilities. These are followed by further investments in juveniles and feed. After the first grow-out period, the

## A Conceptual Framework

Figure 2.9 provides a conceptual framework for thinking about factors affecting the economic viability of a fish farm in a given location growing a particular species of fish. This is a useful conceptual framework to think about how the economic viability of farming in a particular type of location—offshore U.S. waters—compares with the economic viability of farming in other locations, such as inshore waters and foreign waters.

A fish farm is economically viable if the average price per pound received for the fish exceeds the average cost per pound of producing the fish. The cost per pound may be divided into four major cost components: facilities costs, feed costs, juvenile costs, and other operating costs. Each of these cost components is determined by cost parameters, which are driven in part by the farm design. A wide variety of external factors—shown on the left side of the diagram—drive both farm design and cost parameters. Some of the same and other external factors drive supply and demand conditions, which determine the price for which the farm can sell its fish.

Below, we first discuss major farm cost components and cost parameters. We then discuss how these are affected by different external factors, both directly and indirectly through farm design. We then discuss major factors affecting supply, demand and prices.

### Facilities Cost

A marine fish farm requires a variety of capital investments. The most significant investments are typically for cages, boats, feeding and monitoring systems, onshore facilities (docks, storage facilities, and offices), and initial project planning (including design and permitting). For purposes of this discussion, we refer to the cost of these investments as a “facilities cost.”

As discussed in the appendix to this chapter, any given total facilities cost of a fish farm may be converted into an equivalent annual facilities cost per year of production, which may be thought of as the annual equivalent payment that would be required to pay both principal and interest on a loan for the full cost of the investment over the lifetime of the investment.<sup>6</sup>

The facilities cost per pound is equal to:

*(Equivalent annual facilities cost per year of production) / (Annual production in pounds)*

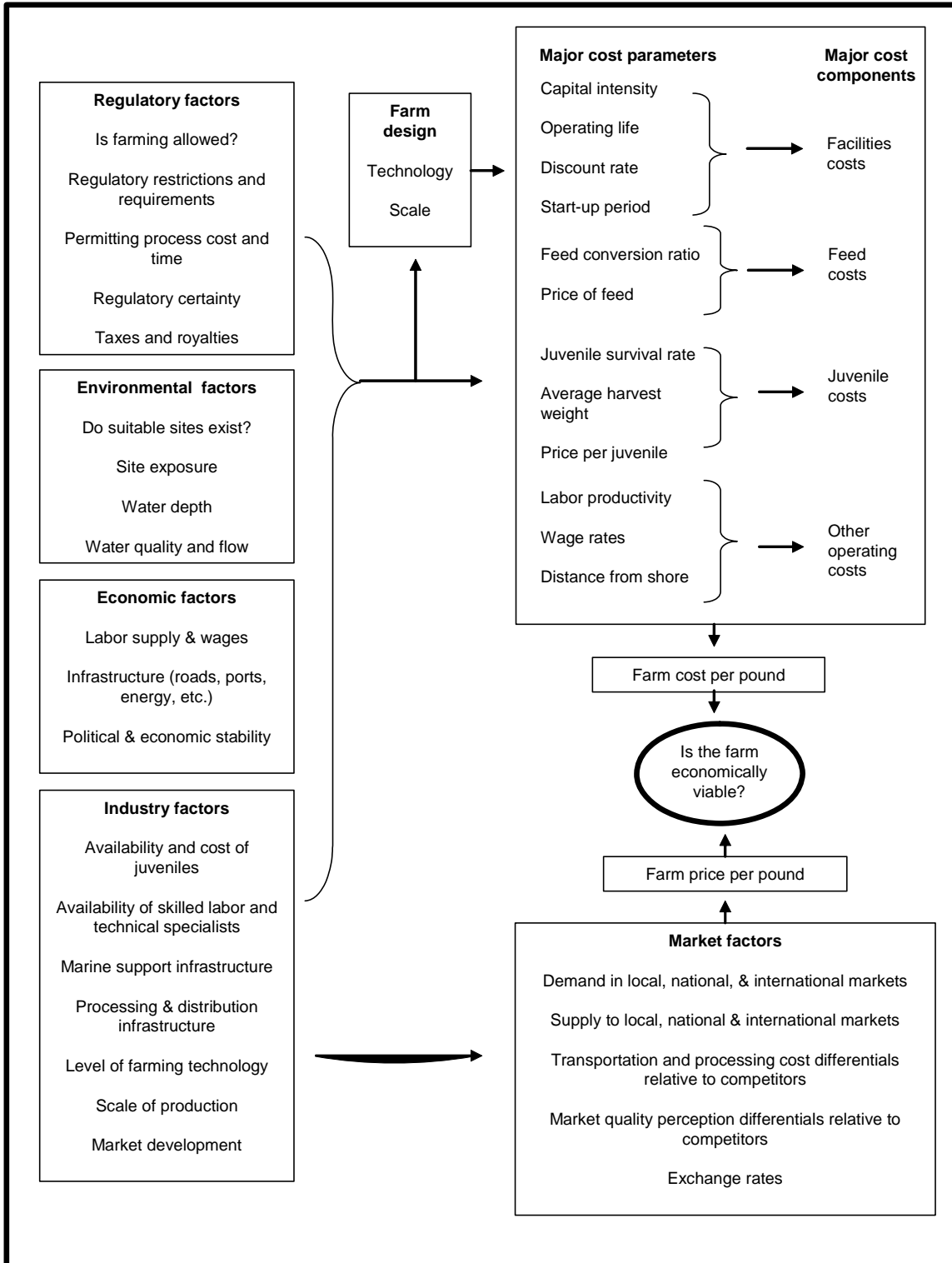
---

fish farm begins to earn revenues as the initial fish are harvested and sold. Over the operating life of the farm, the farm continues to incur additional costs of juveniles and feed as well annual operating and maintenance costs. Analysis of the profitability and economic viability of a fish farm requires comparison of the stream of costs incurred over time with the stream of revenues over time. This may be done using standard methods of investment analysis. In general, a farm is economically viable if the net discounted value of expected revenues over time exceeds the net discounted value of expected costs over time (including the risk-adjusted cost of capital). Thus, profitability depends not just on total costs and revenues, but also on the timing of costs and revenues over the life of the farm, and the risk-adjusted cost of capital.

<sup>6</sup> Financial analyses of fish farms often include “interest” and “depreciation.” The concept of annual facilities cost as used here is approximately equal to the sum of interest and depreciation, with the assumption that interest and depreciation are identical for each year of facility life.



**Figure 2.9. Major factors affecting the economic viability of a fish farm.**



The most important factors affecting facilities cost per pound include:

- Capital intensity. For purposes of this analysis, we define “capital intensity” as the total initial investment per pound of annual production.
- Discount rate. This is the risk-adjusted opportunity cost of capital for the project. Depending on how the project is financed, this may be the interest rate which would be charged on a loan for the investment, or the rate of return which could be earned on an alternative investment of equivalent risk. For any given capital intensity, the higher the discount rate, the higher the facilities cost per pound.
- Operating life. This is the number of years with harvests to which facilities costs may be attributed. For any given capital intensity, the greater the number of years with harvests, the lower the facilities cost per pound.
- Start-up period. This is the period of time from when investments are made until harvests begin. For any given capital intensity, the longer the start-up period, the greater the facilities cost per pound.

Table 2.1 shows several examples of how the discount rate, operating life, and start-up period affect the facilities cost per pound for a fish farm with a hypothetical capital intensity of \$1/lb. Note that for any given capital intensity of a fish farm, all three of these factors may significantly affect facilities costs per pound.

### **Feed Cost**

Feed cost is one of the largest components of finfish farming costs. The most important factors affecting feed cost per pound of fish production include:

- Price of feed. This is the price per pound of feed purchased by the farm.
- Feed conversion ratio (FCR). This is the ratio of the total weight of feed eaten by a crop of fish (from the time they are purchased as juveniles to the time they are harvested) to the weight of the fish at harvest.

Feed cost per pound of fish is equal to:

$$(\text{Price of feed}) \times (\text{Feed conversion ratio}).$$

Table 2.2 shows feed costs per pound for various hypothetical combinations of the price of feed and the feed conversion ratio.

**Table 2.1. Effects of selected factors on facilities cost per pound for a hypothetical fish farm with a capital intensity of \$1/lb.**

Example	Discount rate	Operating life	Start-up period	Total years from investment until final harvest	Facilities cost per pound
A	<b>10%</b>	10	0	10	\$0.16
B	<b>15%</b>	10	0	10	\$0.20
C	<b>20%</b>	10	0	10	\$0.24
D	10%	<b>10</b>	0	10	\$0.16
E	10%	<b>20</b>	0	20	\$0.12
F	10%	<b>100</b>	0	100	\$0.10
G	10%	10	<b>0</b>	10	\$0.16
H	10%	10	<b>2</b>	12	\$0.20
I	10%	10	<b>5</b>	15	\$0.26

Note: All examples assume a capital intensity of \$1/lb (a one-time investment of one dollar per pound of annual production).

**Table 2.2. Feed cost per pound of fish: Effects of price of feed and feed conversion ratio.**

		Price of feed (\$/lb)				
		\$0.30	\$0.40	\$0.50	\$0.60	\$0.70
Feed conversion ratio = pounds of feed per pound of fish	1.00	\$0.30	\$0.40	\$0.50	\$0.60	\$0.70
	1.25	\$0.38	\$0.50	\$0.63	\$0.75	\$0.88
	1.50	\$0.45	\$0.60	\$0.75	\$0.90	\$1.05
	1.75	\$0.53	\$0.70	\$0.88	\$1.05	\$1.23
	2.00	\$0.60	\$0.80	\$1.00	\$1.20	\$1.40
	2.25	\$0.68	\$0.90	\$1.13	\$1.35	\$1.58

Note: Feed Cost per Pound of Fish Produced = (Price of Feed) x (Feed Conversion Ratio).

Feed costs per pound of fish vary depending upon the type of feed, species, feeding technology, and other factors affecting growth and survival rates of fish, including water quality. In general, two opposing trends are likely to affect future feed costs per pound for marine aquaculture. The price of feed may increase as rising feed demand puts upward pressure on prices of fish meal and fish oil, which are major inputs to feed production. Rising prices of feed will increase farmers' incentives to reduce feed costs by improving feed conversion ratios. This may be done in a number of ways, such as reducing fish mortality, developing better feeds that fish are able to utilize more efficiently, improving the timing and method of feeding, utilizing more vegetable-based feeds, and shifting production from carnivorous species to non-carnivorous species. Future aquaculture feed costs per pound will depend on the relative strength of these opposing trends.

### Juvenile Cost

Juvenile cost is another important component of marine aquaculture cost. The most important factors affecting juvenile cost are:

- Price per juvenile. This is the delivered cost of individual juveniles purchased from a hatchery.
- Juvenile survival rate. This is the percentage of juveniles which survive to be harvested. It is equal to the inverse of the number of juveniles per harvested fish.
- Average harvest weight. This is the average weight of fish at harvest.

Juvenile cost per pound of fish harvested is equal to:

$$\frac{(\text{Price per juvenile}) * (\text{Juveniles per harvested fish})}{(\text{Average harvest weight})}$$

$$(\text{Price per juvenile}) / [(\text{Juvenile survival rate}) * (\text{Average harvest weight})]$$

Table 2.3 shows juvenile costs per pound for various hypothetical combinations of price per juvenile, juvenile survival rate, and average harvest weight.

### Relative Scale of Different Cost Components

Fish farming costs vary widely depending upon the species being farmed and where and how it is farmed. In general, however, feed and juveniles represent the largest cost components for most types of finfish farming, while operating costs and facilities costs tend to represent a much smaller share of total cost, even in offshore farms. This basic fact is important in considering the economics of offshore fish farming and its ability to compete with inshore farming, because while operating costs and facilities costs are likely to be higher offshore, feed and juvenile costs are likely to be the same—or potentially lower, if offshore water quality and water flow are better.

**Table 2.3. Effects of Selected Factors on Fish Farm Juvenile Cost per Pound.**

Juvenile survival rate	Avg. harvest weight (lbs)	Price per juvenile							
		\$0.50	\$0.75	\$1.00	\$1.25	\$1.50	\$2.00	\$2.50	\$3.00
100%	2	\$0.25	\$0.38	\$0.50	\$0.63	\$0.75	\$1.00	\$1.25	\$1.50
	4	\$0.13	\$0.19	\$0.25	\$0.31	\$0.38	\$0.50	\$0.63	\$0.75
	6	\$0.08	\$0.13	\$0.17	\$0.21	\$0.25	\$0.33	\$0.42	\$0.50
	8	\$0.06	\$0.09	\$0.13	\$0.16	\$0.19	\$0.25	\$0.31	\$0.38
	10	\$0.05	\$0.08	\$0.10	\$0.13	\$0.15	\$0.20	\$0.25	\$0.30
90%	2	\$0.28	\$0.42	\$0.56	\$0.69	\$0.83	\$1.11	\$1.39	\$1.67
	4	\$0.14	\$0.21	\$0.28	\$0.35	\$0.42	\$0.56	\$0.69	\$0.83
	6	\$0.09	\$0.14	\$0.19	\$0.23	\$0.28	\$0.37	\$0.46	\$0.56
	8	\$0.07	\$0.10	\$0.14	\$0.17	\$0.21	\$0.28	\$0.35	\$0.42
	10	\$0.06	\$0.08	\$0.11	\$0.14	\$0.17	\$0.22	\$0.28	\$0.33
80%	2	\$0.31	\$0.47	\$0.63	\$0.78	\$0.94	\$1.25	\$1.56	\$1.88
	4	\$0.16	\$0.23	\$0.31	\$0.39	\$0.47	\$0.63	\$0.78	\$0.94
	6	\$0.10	\$0.16	\$0.21	\$0.26	\$0.31	\$0.42	\$0.52	\$0.63
	8	\$0.08	\$0.12	\$0.16	\$0.20	\$0.23	\$0.31	\$0.39	\$0.47
	10	\$0.06	\$0.09	\$0.13	\$0.16	\$0.19	\$0.25	\$0.31	\$0.38

Note: Juvenile cost per pound = (Cost per juvenile) / [ (Juvenile survival rate) \* (Average harvest weight) ]

The smaller the share of total costs represented by a particular cost element—such as facilities—the less significant the effect of an increase in that cost element will be in its relative effect on total cost. This basic mathematical principle is illustrated in Table 2.4. For example, suppose facilities costs and feed costs account for 10% and 50% of the total cost of an inshore farming operation, respectively. If facilities costs are 100% higher for an offshore farm, they would result in only a 10% increase in total cost. Such an increase in facilities costs would be fully offset by a 20% decrease in feed costs.

**Table 2.4. Percentage increase in total cost resulting from an increase in one cost component.**

		Percentage of cost component in total cost				
		10%	20%	30%	40%	50%
Percentage increase in cost component	10%	1%	2%	3%	4%	5%
	20%	2%	4%	6%	8%	10%
	50%	5%	10%	15%	20%	25%
	100%	10%	20%	30%	40%	50%
	200%	20%	40%	60%	80%	100%
	300%	30%	60%	90%	120%	150%

### Farm Design

Some cost parameters are influenced by the farm design: the technology used by the farm and the scale of the farm (Figure 2.9). These cost parameters include capital intensity, operating life, feed conversion ratio, juvenile survival rate, and labor productivity. In general, as in other kinds of agriculture, fish farmers face a choice between capital intensity and other cost parameters. By increasing the capital intensity of the farm (which increases facility costs) farmers can achieve better feed conversion ratios, better juvenile survival rates, and higher labor productivity (which lowers feed costs, juvenile costs, and other operating costs).

An important point to recognize is that cost-minimizing design choices for offshore farming may differ from those for inshore farming, and cost-minimizing design choices for U.S. offshore farms may differ from those for foreign offshore farms. For example, if labor costs more per hour for an offshore farm than for an inshore farm, an offshore farm is likely to use relatively less labor—thus reducing the extent to which higher labor costs represent a cost disadvantage.

### Regulatory Factors

Regulatory factors directly affect the economic viability of fish farming—most obviously by prescribing whether farming is allowed at all, but also in numerous other ways. Regulatory restrictions and requirements may limit farm design choices of scale and technology and may impose additional costs, such as environmental monitoring. The permitting process may represent a significant expense which increases with the time required for permitting and the uncertainty associated with the outcome. Regulatory certainty—the likelihood that regulations will stay the same over the life of the farm—affects the risk associated with farming investments

and the discount rate for facilities investments. Taxes and royalties represent additional direct costs.

Put simply, to a significant extent the costs and economic viability of fish farming depends on how it is regulated. Favorable regulation cannot make a fish farm economically viable if environmental, economic, industry, and market factors are unfavorable. But unfavorable regulation can keep a farm from being economically viable even if other factors are favorable.

### **Environmental Factors**

Key environmental factors affecting economic viability of a fish farm include site exposure, water depth, and water flow. Exposure to waves and wind directly determines what kinds of cages and other farm equipment will work, as well as the risks of farm damage and loss of fish. Water depth affects installation costs. Water depth, quality, and flow affect feed costs and juvenile costs by affecting fish growth rates and mortality rates. Water depth, quality, and flow also affect potential environmental effects of a farm and the extent to which these must be mitigated, either because it is in the farmer's own interest or in response to regulatory requirements.

### **Economic Factors**

General economic conditions affect the costs and economic viability of a fish farm. Key economic factors include labor supply and wages, transportation infrastructure, and availability and cost of utilities. Another critical factor is political and economic stability, including protection of property and basic rule of law.

### **Industry Factors**

The costs and economic viability of an individual fish farm are affected by a number of industry factors which depend on the scale and experience of the industry. As the scale of the fish farming industry within a region or nation grows, it creates a demand for specialized aquaculture support activities, such as hatcheries, veterinary services, fish transport, and processing. As the scale of these activities expands, it tends to lower costs and expand the types and scale of farming which are feasible. More generally, experience gained in farming drives technological change. Industry factors may be thought of as "feedback factors" affecting economic viability, in the sense that as an industry grows and gains experience, economies of scale and technological change help to lower costs and further expand the industry.

### **Market Factors**

Price is as important as cost to the economic viability of a fish farm. The price per pound received by a farm is driven by a wide variety of market factors interacting in complex ways. The effects of these factors can generally be described within the supply and demand framework presented earlier in this chapter.

Which market factors are most important depends on the size of the market and the relative scale of competition. If a fish farm is supplying a market or markets which are also supplied with comparable fish of comparable quality from competing sources, the volume of competing supply and the prices offered by competitors are key factors influencing the price received by the farm. Put differently, the price depends on whether the demand for the fish is local, national, or international, and whether the competing supply is local, national, or international.

Different factors also drive prices in the short term (over the course of one or a few years) than over the long term (the expected period of operation of a fish farm). In the short term, prices are driven by the total supply available to the market, given current production. Over the longer term, prices are driven by the capacity of producers to expand or contract production in response to higher or lower prices.

In national and international markets, competition typically occurs at the wholesale level, between fish which have undergone primary processing and been transported either to end-market locations or locations where further processing occurs. The price paid to a fish farm is driven not only by the wholesale price, but also by the costs of processing and transportation, which must be subtracted from the wholesale price. Put differently, whether a fish farm can be competitive is determined not just by the cost of growing the fish, but also by the costs of processing the fish and transporting it to markets. In considering whether a particular farming operation can be competitive, an important factor is how both processing costs and transportation costs to markets compare with those of competitors. A higher-cost farm can be competitive if its products can be processed at a lower cost or shipped to markets at a lower cost than its competitors.

Both processing and transportation costs depend in part on the scale of the industry. A pioneer fish farm in one location may face relatively high processing and transportation costs if the fish processing industry and transportation infrastructure are not well developed. As the industry grows in scale, these costs may decline significantly, making fish farms relatively more competitive. Thus, some of the industry scale factors which affect the costs of a fish farm also affect the prices paid to a fish farm, through their effects on the costs of processing and transportation.

A similarly important factor is the perceived quality of a farm's products compared with competing suppliers' products, as reflected in the relative prices that buyers are willing to pay. A higher-cost farm can be competitive if its products can command a higher price over those of competitors.

### **Competitiveness of U. S. Offshore Aquaculture**

The economic viability of a fish farm depends on its costs and the prices it receives for its products. Prices depend in part on the prices received by competitors in the same markets, which in turn depend in part on competitors' costs. Thus the economic viability of a fish farm depends, in part, on the competitiveness of the farm: how its prices and costs compare with those of competitors supplying the same markets.

Table 2.5 suggests a simple typology of potential competitors for U.S. offshore aquaculture. By “competitor,” we mean a fish producer who might supply similar fish to similar markets as U.S. offshore fish farmers. The table below suggests which producers are most likely to be competitors of U.S. offshore fish farming during “early” development of offshore farming, and which are most likely to be competitors if or when offshore farming achieves large-scale commodity production. Note that wild fisheries are not considered a likely, significant competitor of future large-scale offshore aquaculture production, because those fisheries are unlikely to be able to expand production.

**Table 2.5. A typology of potential competitors for U.S. offshore aquaculture.**

	United States	Other Developed Countries	Undeveloped countries
Offshore farming	←----- ↑ ↓	F ↑ ↓	-----→ F ↑ ↓
Inshore farming	e, f	E, F	E, F
Onshore farming	e		E, F
Wild fisheries	e		

E = major early competitor; e = minor early competitor  
 F = major future competitor; f = minor future competitor  
 Arrows indicate focus of discussion in text.

Following is a discussion of the competitiveness of offshore farming relative to inshore farming, as indicated by the vertical arrows in the table. This is followed by a discussion of the competitiveness of domestic offshore farming, relative to offshore farming abroad. The goal is to highlight key considerations in thinking about the competitiveness of U.S. offshore farming—in particular, reasons why costs and prices may be higher or lower for U.S. offshore farming than for its competitors.

The goal is *not* to discuss the competitiveness of U.S. offshore farming with respect to every potential competitor. For example, no attempt is made to discuss how competitive U.S. offshore farming might be with inshore or onshore farming in other countries.

### **Competitive Disadvantages of Offshore Farming Relative to Inshore Farming**

#### Exposure

Probably the greatest competitive disadvantages of offshore aquaculture derive from the technical challenges and costs of constructing, installing, operating, and maintaining cages and feeding and monitoring systems able to withstand wave and wind conditions in an exposed ocean environment. A more exposed environment also adds to the required sizes and construction and operating costs of support vessels. This cost disadvantage may be significantly reduced where



there are synergies with existing or new offshore facilities built for other purposes, such as offshore oil platforms or (as envisioned for the future) wave power generation installations.

#### Support transport costs

Offshore farms are (by definition) located farther from shore than onshore farms. In general, this will mean that fish, feed, and workers will need to be transported over greater distances, adding to fuel and labor costs. Note, however, that locating a farm farther offshore does not necessarily imply a greater transportation distance when compared to available inshore sites. Depending on terrain, infrastructure development, and the extent of the existing inshore farming industry, offshore facilities will not necessarily be farther from onshore support facilities such as docks and roads than are available protected inshore sites. Put simply, it may be shorter and quicker for a support vessel to travel three miles straight out to sea than five miles up the coast or around a cape to the next bay.

#### Water depth

In general, water depth is greater for offshore farms, and may in some cases be much greater—adding to the costs of mooring systems.

#### Working conditions

Offshore farms will likely need to pay higher wage rates for workers able and willing to work in a harsher and riskier offshore environment and able to work with the more complex technology of offshore farms. Note, however, that higher wage rates may be significantly offset by the use of more capital-intensive and labor-saving technology, such as remote feeding and monitoring systems.

#### Industry economies of scale

The costs of manufacturing cages and offshore feeding and monitoring systems depend upon the scale at which they are produced. Currently, far fewer cages and feeding and monitoring systems are being built for offshore farming than for inshore farming. Over time, as the scale of offshore investment expands, it will help to lower manufacturing costs for offshore cages and feeding and monitoring systems.

#### Operating experience

For almost any economic activity, operating experience helps to identify better and cheaper ways of doing things. Worldwide, there has been far less experience in building and maintaining offshore farms than inshore farms. Over time, as more experience is gained with offshore farming, costs are likely to decline at a relatively greater rate.

#### Regulatory experience

Experience with the regulation of offshore farming lags behind the regulation of inshore aquaculture. Regulatory frameworks and effective methods for offshore farm monitoring and regulatory enforcement may not be in place. Potential jurisdictional and legal issues may not have been resolved. This lack of experience is likely to increase the difficulty, time, costs, and risks associated with applying for offshore sites and meeting regulatory requirements. Over time, as more regulatory experience is gained, these offshore costs are likely to decline until they compare with those of inshore farming.

## **Competitive Advantages of Offshore Farming Relative to Inshore Farming**

### Water quality

Water quality is critical to successful fish farming. In general, offshore farms will have more water flow than inshore farms. Offshore farms are also less likely to be affected by pollution from land-based sources, such as agricultural runoff. Better water quality contributes to better growing conditions for fish and is reflected in better feed conversion and survival rates, lowering the costs of feed, juveniles, and facilities and other costs (on a per-pound basis).

### Availability of sites

For much of the world's coastlines, "inshore" farming is not an option because there are no protected waters in which to locate such farms. In areas with protected waters, inshore farming may still not be possible because available sites are already being used. In addition, the best inshore sites tend to be used first, so new inshore sites will be even less economically competitive, relatively speaking, with offshore sites. In contrast, available sites for offshore farming are almost limitless in comparison to the potential scale of offshore farming for the foreseeable future.

### Conflicts with other activities

Because of their greater distance from shore, offshore farms are likely to experience fewer conflicts with other economic and recreational uses of the environment. This reduced potential for conflicts may result in fewer restrictions on farm size and greater economies of scale, as discussed below.

### Environmental impacts

Because of greater water flow and depth, the potential for fish feces, fish feed, or other farm residues to concentrate in the water or on the ocean bottom is comparatively less. The potential for interaction with species migrating close to shore or with concentrations of migrating anadromous fish is also less. Such reduced environmental impacts may result in fewer restrictions on farm size and greater economies of scale.

### Farm economies of scale

Because of the greater availability of suitable large-scale farming sites and the potential for fewer regulatory restrictions on farm size, offshore farms have the potential to be larger, allowing for reduced costs through greater economies of scale.

### Distance from markets

Because of reduced conflicts with other activities and greater availability of sites, it may be possible to locate offshore farms closer to markets (such as major cities), thus reducing transportation costs and making it possible for fresher products to be delivered to markets. This may, in turn, allow some offshore farms to capture higher prices than more distant, inshore farms.

## **Other Considerations for the Competitiveness of Offshore Farming with Inshore Farming**

An uncertain factor affecting the relative economic viability of offshore aquaculture is its relative *political viability*: the choices of society—through the political process and legal, political, and regulatory institutions at local, state, and national levels—about whether to allow offshore aquaculture and how to regulate it. The relative political viability of offshore aquaculture may depend on the relative geographical distribution of perceived costs and benefits.

Suppose inshore aquaculture is regulated by multiple local (state-level or lower) authorities, while offshore aquaculture is regulated by a single, national authority. A simple political theory would suggest that regulation of inshore aquaculture would reflect perceptions at local levels of the relative costs and benefits of inshore aquaculture, while regulation of offshore aquaculture would reflect national perceptions of these costs and benefits. The relative geographical distribution of perceived costs and benefits of inshore and offshore aquaculture is likely to differ for different regions and different types of farming. This may result in more economically favorable local regulation of inshore aquaculture in some areas, and less economically favorable regulation of inshore aquaculture in other areas—relative to national standards for offshore regulation.

### **Competitiveness of Offshore Farming with Inshore Farming: Summary**

As summarized in Table 2.6, a large number of factors may affect the relative competitiveness of offshore farming with inshore farming in different ways, through their effects on costs, on price, and more. There is no obvious or single answer about whether offshore farming could be competitive with inshore farming. The answer depends upon the specific circumstances of location and species farmed. In general, facility and operating costs are likely to be higher for offshore farming. However, these cost disadvantages may be offset by improved water quality, greater availability of sites, fewer conflicts with other activities, and reduced environmental impacts. As offshore aquaculture grows in scale and experience, it will tend to become relatively more competitive.

Wherever it develops, large-scale offshore fish farming will be an inherently capital- and technology-intensive activity. It will generally tend to look the same. As a result and as discussed below, the differences between the United States and other countries which might affect the competitiveness of U.S. offshore farming are likely to be less dramatic than the differences between offshore and inshore farming.

#### *Environmental conditions*

The United States EEZ is a very large area extending from the Arctic to the tropics, with a wide range of temperature, depth, wave, wind, and ice conditions. In general, the United States has favorable water temperatures for a wide variety of offshore aquaculture. However, in much of this area, other environmental factors—such as wave exposure—are less favorable compared to some potential foreign competitors. U.S. offshore aquaculture is most likely to be successful where favorable water temperature and wave exposure conditions for the offshore farming of a species combine with favorable economic conditions—particularly infrastructure and distance to markets.

**Table 2.6. Selected factors which may affect the relative competitiveness of offshore farming with inshore farming (N = negative factors; P = positive factors).**

	Type of effect					
	Facility costs	Feed costs	Juvenile costs	Other costs	Price	Other effects
Exposure	N			N		
Support transport costs				N		
Water depth	N					
Working conditions				N		
Industry economies of scale	N*					
Operating experience	N*			N*		
Regulatory experience						N*
Water quality	P	P	P	P		
Availability of sites						P
Conflicts with other activities						P
Environmental impacts						P
Farm economies of scale	P			P		
Distance from markets					P	
Political viability						?

\*Factors likely to decline in significance over time as the scale of offshore aquaculture increases and more experience is gained.

## Competitiveness of United States Offshore Farming with Foreign Offshore Farming

### Feed prices

Feed costs represent the single, most important cost component for many kinds of fish farming. Aquaculture feeds and feed components (fish meal, fish oil, and vegetable-based feed inputs such as soybeans) are globally traded products for which prices follow similar trends worldwide. Thus, in general, feed prices are unlikely to represent either a major competitive disadvantage or advantage for U.S. offshore farms.

However, feed prices may differ to the extent that they are impacted by transportation costs. U.S. agricultural products, such as soybeans, are becoming an increasingly important ingredient in world fish feed production. Lower costs of transporting these agricultural feeds could become a competitive advantage for U.S. offshore farming, as is the case for domestic livestock production.

Note also that feed costs depend not only on feed prices but also on the efficiency of feed utilization. To the extent that U.S. offshore farms are able to achieve better feed conversion ratios through better water quality and superior technology, they may enjoy a competitive advantage in feed costs.

### Juvenile costs

Juveniles represent another major cost of fish farming. The production of juveniles may be considered a specialized type of onshore fish farming. Major cost factors for juvenile

production include facilities costs, labor costs, level of technology, and scale of production. Clearly, the United States is able to produce juveniles for commercial fish farming at a price and on a scale which is globally competitive. For example, Washington-based Troutlodge, Inc. is a world-renowned trout and salmon breeding company, exporting trout eggs to 26 foreign countries.<sup>7</sup> The United States produces very large quantities of juveniles for recreational fisheries and salmon hatcheries, including the extensive Alaska salmon hatchery system which supports major Alaska commercial pink and chum salmon fisheries. In the short-term, however, local hatchery capacity may be limited or non-existent for some of the species which are potential candidates for U.S. offshore farming. This may represent an important competitive disadvantage until U.S. marine fish farming—including offshore farming—reaches a larger scale.

#### Distance to U.S. markets

One of the most important competitive advantages of U.S. offshore farming may be the shorter distance to U.S. markets. This is particularly important for fresh fish which would have to be shipped by air to reach U.S. markets. It is relatively less important for the large-scale production of frozen fish. In the future, “food miles” could become an important factor for some markets where consumers or buyers are concerned about greenhouse gas releases associated with food production and transportation. If so, this would tend to favor domestic producers of fish in supplying the U.S. market. Note that this transportation cost advantage would not apply equally to all U.S. offshore aquaculture production. Alaska, in particular, is located a significant distance from U.S. markets.

#### Labor costs

Although typically less than feed and juvenile costs, labor also represents a significant cost factor in fish farming. In general, annual costs per worker (wage rates and benefits) in the United States are similar to those in other developed countries that are potential competitors (such as Canada and Norway). But U.S. costs are higher than those of less economically developed, potential competitors (such as Chile and Vietnam). Given the geography of world economic development, labor cost differentials are more likely to be a significant competitive factor for warm-water offshore farming than for cold-water offshore farming. Wherever it occurs, offshore farming is likely to be highly mechanized and will utilize relatively fewer, but more skilled, workers than inshore farming. As a result, the fact that some potential competitors have lower labor costs may not be a particularly significant factor for the competitiveness of U.S. offshore fish farming.

Put differently, higher labor costs do not mean that the United States could not compete in offshore fish farming. Norway and Chile currently dominate world production of farmed salmon. Although Norway has higher labor costs, it is able to compete successfully with Chile in many (but not all) markets due to other advantages, such as lower transportation costs.

Differences in labor costs may represent an important consideration for the competitiveness of U.S. offshore fish farming not so much in farming but in the subsequent processing of fish. Some types of fish processing, such as extracting pin-bones from salmon, are

---

<sup>7</sup>Source: [www.troutlodge.com](http://www.troutlodge.com).

highly labor intensive. Increasingly, U.S. fish (Alaska salmon and pollock, for example) are being frozen and exported to low-labor cost countries such as China for value-added processing into products such as portioned fillets for re-export to markets in the United States and Europe. For species or products requiring labor-intensive processing, U.S. labor costs or the costs of shipping fish to other countries for processing could offset the potential transportation-cost advantage of growing fish closer to U.S. markets.

#### Facilities costs

In well-developed aquaculture industries, such as salmon farming, cage design tends to be similar worldwide. However, cages are usually built locally, and cage costs may differ according to labor costs and local availability of materials. Other offshore farming facilities and equipment—including nets, monitoring and feeding systems, and the large boats which would be used to support them—are sourced globally and are likely to cost about the same, regardless of where farming occurs.

#### Industry scale

The U. S. marine aquaculture industry is currently much smaller than that of major marine fish farming countries such as Norway and Chile. This represents a potential competitive disadvantage with respect to the availability and cost of specialized support infrastructure (such as hatcheries) and technical support services (such as veterinary services). These disadvantages would decline over time as a domestic marine farming industry grows in scale. One of the most important components of support infrastructure—the fish processing industry—is well developed in many areas of the United States where large-scale wild fisheries are found. Marine aquaculture production could improve the utilization of existing processing facilities, thus lowering those costs for wild fisheries.

#### Economic infrastructure

With the significant exception of many parts of Alaska, the United States has a highly developed physical and service infrastructure—roads, airports, utilities, construction services, vessel repair and maintenance services, electronics installation and repair services, for example. This represents a competitive advantage for the United States in offshore farming over less developed countries, and would help to offset the labor cost advantages these countries may enjoy.

#### Political and economic stability

For major investments such as offshore fish farms, political and economic stability—in particular the security of property rights and the rule of law—is essential. With regard to some less developed countries, the fact that the United States is a stable and safe place to do business may be a significant competitive advantage.

### **Economic Modeling of U.S. Offshore Aquaculture**

As suggested by the preceding discussion, there is no single answer about the economic viability of U.S. offshore fish farming. The economic viability of offshore fish farms may vary widely depending upon where they are located, the species that are farmed, how they are

regulated, how they are designed, and the scale of operation. Economic viability may also change over time as the scale of the industry changes and as markets change.

To move beyond these general conclusions to a more formal assessment of the prospects for a particular type of farm—or for U. S. offshore aquaculture in general—requires the development of models that explicitly consider both expected costs and prices. Such models may range from simple “back of the envelope” models based on rules-of-thumb for different types of costs, to complex systems of equations based on numerous, carefully researched assumptions.

Table 2.7 provides an example of a relatively simple economic model of a hypothetical offshore fish farm for a hypothetical fish species. It is not intended to represent actual costs or prices for any particular fish species, or the economic viability of any particular kind of fish farming. It simply presents one potential approach to economic modeling of a fish farm. There are many other potential approaches. Which approach is best depends on the purpose for which the model is being developed and the reliability of the assumptions on which that model is based. In general, more complex models may be used to address more complex questions but require more assumptions and may be harder to understand. (Chapter 6 of this study provides an example of a more complex economic model of an offshore fish farm.)

The model is driven by 21 assumptions: 9 technical assumptions (rows 1-9) and 12 price and cost assumptions (rows 10-21). All of the model outputs (rows 22-53) are driven by these 21 assumptions. The fifth column of the table (“Explanation or formula”) explains how outputs are calculated from the assumptions. The sixth column illustrates the model calculations, based on hypothetical technical, price, and cost assumptions.

The model incorporates three common economic viability indicators: net present value, internal rate of return, and annual economic profit (rows 44-46). These all depend upon operating profit, total investment, the cost of capital, the facility life, and the start-up period. The “net present value” indicator shows whether the net present value of the farm’s annual operating profits over the facilities life exceeds the cost of the investment. The “internal rate of return” indicator shows whether the farm’s annual operating revenues are providing a rate of return which exceeds the annual cost of capital. The “annual economic profit” indicator shows the farm’s annual profits after subtracting the “annual economic cost of capital” (row 42), defined as what equal annual payments would be on a loan for the total investment cost paid off over the period of time for which harvests occur.

Economic models such as the one in Table 2.7 are important tools for analyzing the economic viability of offshore fish farming. Perhaps the first benefit of economic models is that they require the user to think systematically about costs and prices. This can be difficult, particularly for farms which do not yet exist and for which those costs and prices cannot actually be observed. However, ultimately there is no substitute for careful thinking about what the costs and prices may be, utilizing the best available information—particularly when contemplating actual investments.

**Table 2.7. Economic model of a hypothetical offshore fish farm.**

	Row	Variable name	Units	Explanation or formula	Value
Technical assumptions	1	Annual production volume	pounds	Total annual production of farm operation	10,000,000
	2	<b>Production per cubic meter*</b>	pounds	Net pen production per cubic meter	<b>40</b>
	3	Individual pen volume	meters <sup>3</sup>	Volume of an individual net pen	10,000
	4	Average weight	pounds	Average weight of fish at harvest	7
	5	<b>Juvenile survival rate*</b>	%	% of juvenile fish which survive to harvest	<b>80%</b>
	6	<b>Feed conversion ratio*</b>	ratio	Pounds of feed per pounds harvested	<b>1.2</b>
	7	Productivity	pounds	pounds per person per year	600,000
	8	Facility life	years	Years from investment to final harvest	15
	9	Startup period	years	Startup years without harvests	1
Price & cost assumptions	10	<b>Fish price*</b>	\$	Price received per pound, FOB processor	<b>\$1.30</b>
	11	<b>Net pen cost per cubic meter*</b>	\$	Fully-installed cost per cubic meter of net pen	<b>\$30</b>
	12	Other offshore investment per pen	\$	Costs of feeders and other equipment per pen	\$50,000
	13	Other investment	\$	Support vessels and onshore facilities	\$1,500,000
	14	<b>Cost per juvenile*</b>	\$	Cost per juvenile fish, including interest	<b>\$1.65</b>
	15	<b>Feed cost per pound*</b>	\$	Cost of feed per pound	<b>\$0.33</b>
	16	Average staff cost	\$	Average annual staff pay and benefits	\$50,000
	17	Fish insurance rate	%	Percentage of annual production value	4%
	18	Facilities insurance rate	%	Percentage of value of investment	2%
	19	Other annual costs	\$	Annual costs of fuel, diving, utilities, monitoring, & administration	\$880,000
	20	Annual repair and maintenance rate	%	Annual cost of repairs and maintenance expressed as a percentage of total fixed capital investment	7%
21	<b>Annual cost of capital rate*</b>	%	Annual cost of capital expressed as a % of total fixed capital investment	<b>15%</b>	
Technical outputs	22	Total pen volume	meters <sup>3</sup>	(Annual production) / (production per cubic meter)	250,000
	23	Number of net pens	number	(Total net pen volume) / (Individual net pen volume)	25
	24	Annual fish	number	(Annual production) / (Average weight)	1,428,571
	25	Number of juveniles	number	(Annual # of fish produced) / (Juvenile survival rate)	1,785,714
	26	Volume of feed	pounds	(Annual production) x (Feed conversion ratio)	12,000,000
	27	Number of staff	number	(Annual production) / (Productivity)	16.7
Investment outputs	28	Net pen investment	\$	(Total pen volume) x (Net pen cost per cubic meter)	\$7,500,000
	29	Other offshore investment	\$	(Other offshore investment per pen) x (Number of net pens)	\$1,250,000
	30	Total investment	\$	(Net pen investment) + (Other offshore investment) + (Other investment)	\$10,250,000



**Table 2.7 (continued). Economic model of a hypothetical offshore fish farm.**

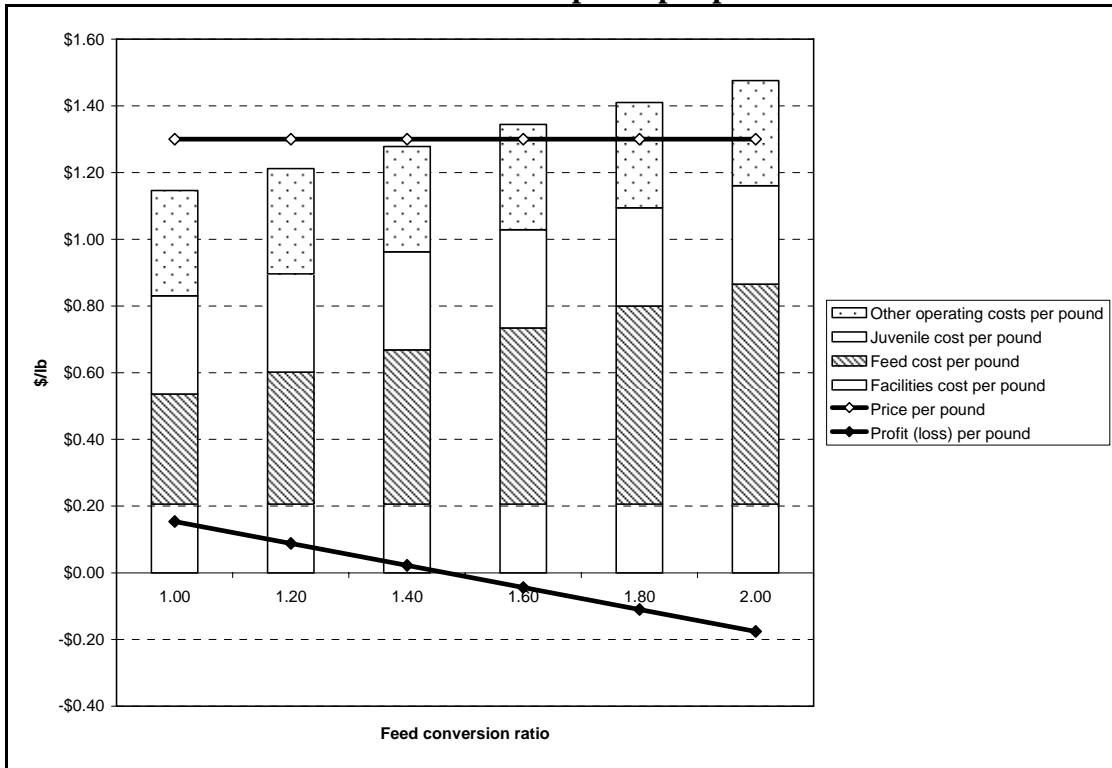
	Row	Variable name	Units	Explanation or formula	Value
Operating cost outputs	31	Cost of juveniles	\$	(Number of juveniles purchased) x (Cost per juvenile)	\$2,946,429
	32	Cost of feed	\$	(Volume of feed) x (Feed price per pound)	\$3,960,000
	33	Payroll cost	\$	(Number of staff) x (average staff cost)	\$833,333
	34	Fish insurance cost	\$	(Fish insurance rate) x (Annual sales value)	\$520,000
	35	Facilities insurance cost		(Facilities insurance rate) x (Total fixed capital investment)	\$205,000
	36	Repair & maintenance cost	\$	(Annual repair & maintenance rate) x (Total fixed capital investment)	\$717,500
	37	Other costs	\$	(Assumed)	\$880,000
	38	Annual operating cost	\$	Total of operating costs listed above	\$10,062,262
Summary financial outputs	39	Annual sales	\$	(Annual volume) x (Fish price)	\$13,000,000
	40	- Annual operating cost	\$	Calculated above	\$10,062,262
	41	<b>(=) Annual operating profit (or loss)</b>	<b>\$</b>		<b>\$2,937,738</b>
	42	- Annual economic cost of capital	\$	See discussion in text	\$2,059,141
	43	<b>(=) Annual economic profit (or loss)</b>	<b>\$</b>		<b>\$878,598</b>
	44	Annual economic profit (or loss)	\$	(Annual operating cost) - (annual cost of capital)	\$878,598
Economic feasibility indicators	45	Net Present Value	\$	See discussion in text.	\$4,373,487
	46	Internal Rate of Return	%	See discussion in text.	22%
Costs, price and profits per pound	47	Feed cost per pound	\$/lb	(Cost of feed) / (Annual production volume)	\$0.40
	48	Juveniles cost per pound	\$/lb	(Cost of juveniles) / (Annual production volume)	\$0.29
	49	Other operating costs per pound	\$/lb	(Sum of rows 33-37) / (Annual production volume)	\$0.32
	50	Facilities cost per pound	\$/lb	(Row 42) / (Annual production volume)	\$0.21
	51	Total cost per pound	\$/lb	(Sum of rows 47-50)	\$1.21
	52	Price per pound	\$/lb	Fish price	\$1.30
	53	Profit (loss) per pound	\$/lb	(Price per pound) - (total cost per pound)	\$0.09

Note: Critical factors affecting economic viability are shown in **bold**.

Sensitivity analysis

A second benefit of an economic model is that it provides a mechanism for testing the implications of changes in model assumptions. In thinking about economic viability, what is important is not just the best estimate of economic viability, but how this estimate might be affected by changing key model assumptions. For example, Figure 2.10 illustrates how different assumptions about the feed conversion ratio for our hypothetical fish farm affect feed cost per pound and profit per pound. At feed conversion ratios of less than 1.47 the farm is profitable; at higher feed conversion ratios the farm is not profitable.

**Figure 2.10. Effect of feed conversion ratio on profit per pound.**

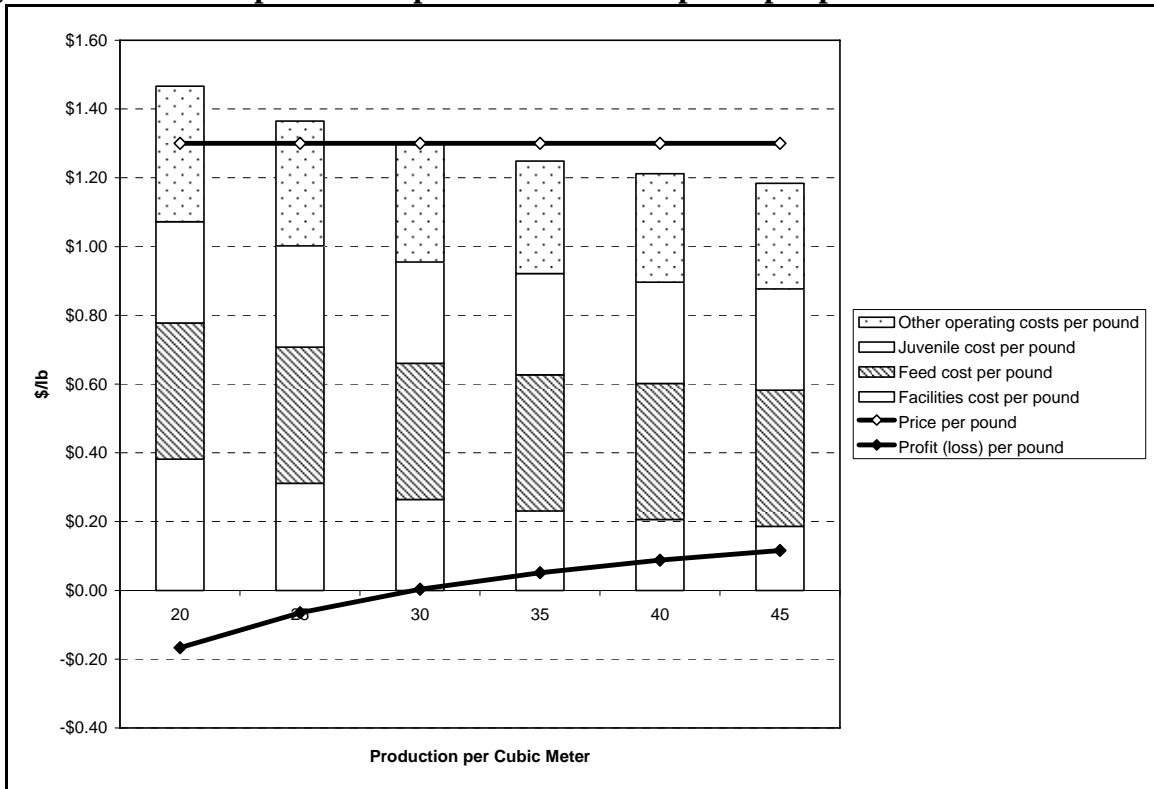


As another example, Figure 2.11 illustrates how different assumptions about production per cubic meter affect facilities cost per pound and profit per pound. If annual production per cubic meter is 30 pounds or higher, the farm is profitable; if production is lower, the farm is not profitable.

Optimization analysis

Investors face numerous choices in the design of a fish farm. For example, the scale of a farm may affect costs in many ways, ranging from initial investment costs to labor costs. A third benefit of an economic model is that it can be used to refine the design of a farm to explore trade-offs between different design choices and to minimize costs or maximize profits. Similarly, economic models may be used to examine the implications of how farms are regulated—such as imposing size limits.

**Figure 2.11. Effect of production per cubic meter on profit per pound.**



Economic impact analysis

Economic models of particular farming operations can provide the starting assumptions for analysis of economic impacts, both direct and indirect—such as the jobs and income that might be created by offshore farming. (Chapter 7 of this study provides an example of a model of potential economic impacts of offshore fish farming.)

This brief discussion of modeling has addressed only the modeling of the economic viability of an individual fish farm. To formally analyze the economic potential for the U.S. offshore farming industry would be a much more complex task. Doing so would require developing not one, but a set of economic models of different kinds of farms for varying fish species in different types of locations. It would also require systematic analysis of U.S. and global fish markets to examine how U.S. and global prices may change in the future for those species which might be produced by domestic offshore farms—and how those markets might be affected, over time, by the development of U.S. offshore farming.

**The Limits of Economic Analysis for Assessing Economic Potential**

The true test of the economic potential of an industry is not an economic study or model. It is the market. Successful new industries do not develop because of government-sponsored “intelligent design.” Successful new industries develop because many new ideas are tried—and some of those ideas prove profitable. Government can best stimulate development of new industries by allowing and encouraging new ideas to be tried.

At present, offshore aquaculture in this country is in the same situation as farming would be if all land were publicly owned and there was no clear process for obtaining a right to farm public lands. The federal government controls federal waters. No matter how interested investors may be in taking risks to develop offshore aquaculture, they cannot do so without federal authorization. U.S. offshore aquaculture cannot develop without an enabling regulatory structure.

This does not, of course, mean that an enabling regulatory structure would necessarily lead to a profitable or large-scale domestic offshore aquaculture industry. But the fact that some investors are interested in offshore aquaculture in the United States suggests that certain types of offshore fish farming may be feasible at some scale. The only way to know if they are feasible is to allow them to be tried.

The success of some offshore fish farms, over time, will help make offshore fish farming more viable, as experience is gained, technology develops, and the scale of the industry grows. Thus, offshore aquaculture could become a profitable and valuable new industry for the United States.

## **Conclusions**

A wide spectrum of offshore aquaculture could potentially be undertaken within the vast area of the U.S. Exclusive Economic Zone. Many different species could potentially be farmed, in many different places, using many different kinds of technologies, for many different markets. There is no single answer about the economic potential for these many types of endeavors. The answers vary for different species, locations, and technologies.

The world offshore aquaculture industry remains in its infancy. There has been only limited experience on which to judge its future potential. It is impossible to know with certainty what the long-run economic opportunities for U.S. offshore aquaculture may be.

Offshore aquaculture will face competition from other sources of fish supply, including inshore aquaculture, foreign offshore aquaculture, and wild fisheries. To be economically viable, domestic offshore aquaculture does not necessarily have to match competitors' costs of production. Even if U.S. offshore farming costs are higher, the industry can be viable if lower-cost competitors are highly profitable; if U.S. offshore farming can command a price premium over lower-cost competitors; or if lower-cost competitors are unable to meet the demands of specific market niches.

In meeting growing domestic and world demand for fish, U.S. offshore aquaculture has both potential competitive disadvantages and advantages relative to other aquaculture producers. Table 2.8 summarizes some of the potentially most significant of these.

**Table 2.8. Potential competitive disadvantages and advantages of U.S. offshore aquaculture.**

	Potential competitive disadvantages	Potential competitive advantages
Relative to inshore farms	Technological challenges in constructing cages and feeding and monitoring systems able to withstand exposed ocean environment Higher costs of capital facilities Higher costs of transportation	Greater availability of potential farming sites Higher water quality Fewer conflicts with other economic and recreational activities
Relative to foreign farms	Higher labor costs Small scale of existing U.S. marine aquaculture industry and support industries	Lower costs of transportation to local markets and to the U.S. market High level of technological development Well-developed transportation infrastructure Highly skilled work force Stable political and economic system

In competing with wild fisheries, in general, it will be difficult for U.S. offshore aquaculture to compete with those for which supply is year-round, reliable, and abundant. However, where wild fisheries are unable to meet market demand for a species at particular times, in particular locations, or for particular product characteristics, competitive opportunities will be created for aquaculture, including offshore aquaculture.

At its current scale and given current technology, offshore aquaculture is a relatively high-cost way of growing fish. Currently, in the United States and elsewhere, offshore aquaculture is probably able to compete with inshore aquaculture only under limited circumstances, such as:

- When offshore farms are able to supply market niches which cannot be supplied by inshore farms, for reasons such as a lack of suitable sites, regulatory constraints, and transportation costs.
- When offshore weather and wave conditions are relatively mild, reducing the costs of building and operating offshore facilities relative to inshore aquaculture.
- When offshore farms enjoy significantly better water conditions than inshore farms, enabling faster growth or better survival.
- When offshore farms are able to take advantage of cost-lowering synergies with other facilities or activities, such as existing inshore farm facilities or offshore oil rigs.

Over time, however, the economic potential for offshore aquaculture—including U.S. offshore aquaculture—is likely to grow, for several reasons:

- Growing population and income will increase world demand for fish, raising prices and increasing the utilization of limited onshore and near-shore areas suitable for aquaculture. These same factors will also increase the relative value of competing uses of potential onshore and inshore farming areas.
- Technological change is likely to lower the cost of offshore aquaculture relative to inshore aquaculture. As in all industries (including onshore and inshore aquaculture) there will be a learning curve for U.S. offshore aquaculture. Over time, experience will help to identify ways to reduce costs (as well as operational designs and practices to minimize environmental impacts).

- As offshore aquaculture grows, economies of scale will help to bring costs down.

Among the most important factors affecting the economic potential for U.S. offshore aquaculture will be:

- The extent and pace of technological development in areas such as remote monitoring, remote feeding, and cage construction, and the extent to which these technological developments can reduce costs and risks of offshore farming.
- The extent to which offshore farms are able to achieve better growth rates and survival than inshore farms.
- The extent to which offshore facilities face fewer conflicts with other activities than inshore farms.
- The extent to which offshore farming is able to develop to a level at which it begins to realize significant economies of scale, and to spur development of key supporting industries such as hatcheries, veterinary services, cage manufacture, and processing.
- The extent to which an enabling regulatory framework establishes clear, stable, and timely processes for permitting and regulating offshore farms.

The economic potential for U.S. offshore aquaculture depends critically on how it is regulated. Part of the answer to the question, “What kind of offshore aquaculture could we have?” depends on the answer to the question, “What kind of offshore aquaculture do we want?”

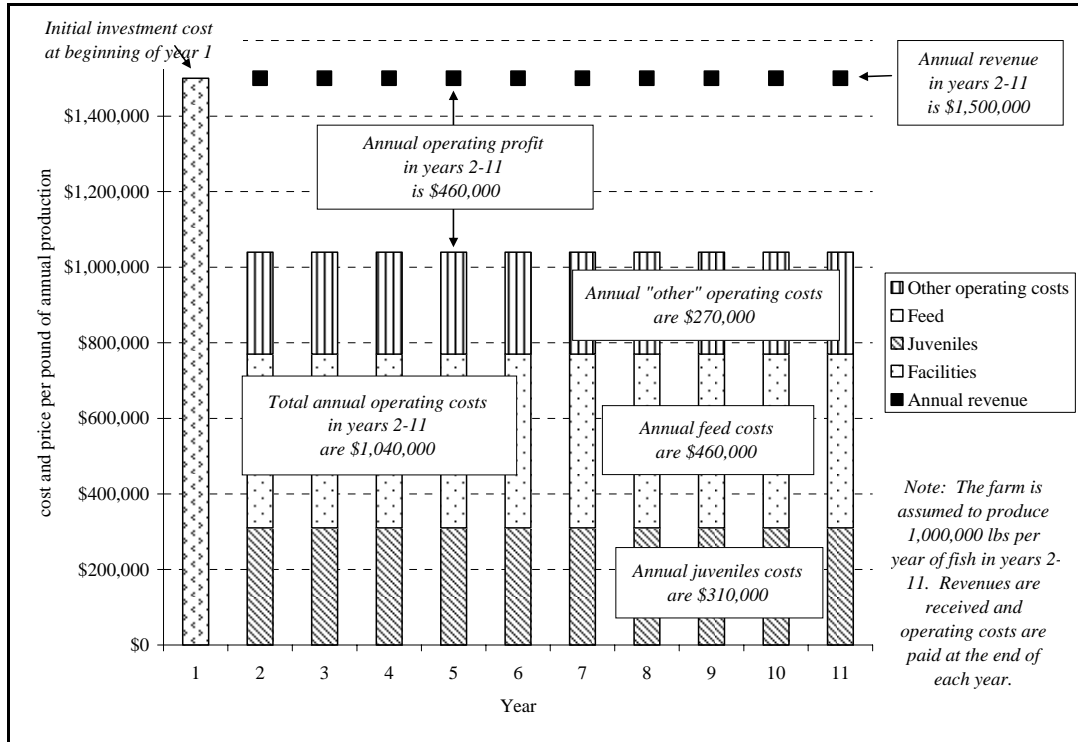
The true test of the economic potential of any industry is the market. No offshore aquaculture industry can develop in the United States without an enabling regulatory structure. Only by letting offshore aquaculture be tried can we learn what its economic potential might be.

### **Appendix: Converting Fish Farm Costs and Revenues to Costs and Prices per Pound**

This appendix presents a simple approach to assessing the economic viability of a fish farm by converting costs and revenues over time to costs per pound and price per pound.

A fish farm experiences a series of costs and revenues over time. As illustrated for a hypothetical fish farm in Figure 2.A1, costs include both initial investments in facilities (cages, boats, and other capital equipment) as well as annual costs for juveniles, feed, and other operating costs (labor, utilities, insurance, administration, etc.). Revenues begin only after a start-up period in which initial investments are made.

**Figure 2.A1. Costs, revenues and operating profits for a hypothetical fish farm.**



Formally assessing the economic viability of a fish farm requires comparing these costs and revenues at different points in time. Using standard investment analysis, a fish farm is economically viable if the net present value of the stream of costs and revenues over time is positive, or if:

$$NPV = \sum(R_t - C_t)^{-(1+r)t} \geq 0$$

As shown in Table 2.A2, the net present value and economic viability of our hypothetical fish farm depends on the discount rate. The higher the discount rate, the lower the net present value. At a discount rate of 17.8%, the net present value falls to zero and the farm is barely economically viable. At higher discount rates, the farm is not economically viable.

**Table 2.A2. Net present value of a hypothetical fish farm.**

Discount rate	Payment	Years	Net Present Value				
			10.0%	13.0%	16.0%	17.8%	19.0%
Investment costs	-\$1,500,000	1	-\$1,500,000	-\$1,500,000	-\$1,500,000	-\$1,500,000	-\$1,500,000
Operating costs	-\$1,040,000	2-11	-\$5,281,281	-\$4,419,526	-\$3,735,550	-\$3,391,304	-\$3,186,563
Revenues	\$1,500,000	2-11	\$7,617,232	\$6,374,317	\$5,387,813	\$4,891,305	\$4,596,005
Total			\$835,951	\$454,791	\$152,263	\$0	-\$90,559
Is the farm economically viable?			Yes	Yes	Yes	Barely	No

Calculating and comparing the net present value of different kinds of aquaculture projects, as illustrated in Table 2.A2, is complicated. We may simplify the analysis and

comparison by expressing all costs and revenues on an average, per-pound basis. This involves the following steps:

- Calculate average price per pound received for the fish
- Calculate average annual operating costs per pound, expressed as of the time of sale of the fish. Thus, the costs of juveniles and feed would include interest costs for the period of time between when costs are incurred and when fish are sold.
- Express facilities cost per pound on an “equivalent annual cost” basis. This translates investment costs in facilities such as net-pens into equivalent costs per year of production.<sup>8</sup>

If we express all revenues and costs on an average per-pound basis, then the fish farm is economically viable if the price per pound exceeds the total cost per pound (including the equivalent annual cost per pound of facilities investments). Mathematically, if all revenues and costs are converted to an average per-pound basis as described above, the total cost per pound will be less than the price per pound only if the net present value of revenues minus costs is greater than zero.

Table 2.A3 illustrates these calculations for our hypothetical fish farm. Note that as the discount rate increases, the facilities cost per pound increases and the profit per pound declines. At a discount rate of 17.8%, the profit per pound falls to zero and the farm is barely economically viable. At higher discount rates, profit per pound is negative and the farm is not viable.

**Table 2.A3. Price, cost and profit per pound for a hypothetical fish farm.**

	<i>Discount rate</i>	<i>10.0%</i>	<i>13.0%</i>	<i>16.0%</i>	<i>17.8%</i>	<i>19.0%</i>
<b>Cost per pound</b>	Facilities costs per pound*	\$0.30	\$0.35	\$0.42	\$0.46	\$0.49
	Feed costs per pound	\$0.31	\$0.31	\$0.31	\$0.31	\$0.31
	Juvenile cost per pound	\$0.46	\$0.46	\$0.46	\$0.46	\$0.46
	Other operating costs per pound	\$0.27	\$0.27	\$0.27	\$0.27	\$0.27
	<b>Total cost per pound</b>	<b>\$1.34</b>	<b>\$1.39</b>	<b>\$1.46</b>	<b>\$1.50</b>	<b>\$1.53</b>
	<b>Price per pound</b>	<b>\$1.50</b>	<b>\$1.50</b>	<b>\$1.50</b>	<b>\$1.50</b>	<b>\$1.50</b>
<b>Profit or loss per pound</b>	<b>\$0.16</b>	<b>\$0.11</b>	<b>\$0.04</b>	<b>\$0.00</b>	<b>-\$0.03</b>	
<i>Is the farm economically viable?</i>	<i>Yes</i>	<i>Yes</i>	<i>Yes</i>	<i>Barely</i>	<i>No</i>	

\*Facilities costs per pound are expressed on an equivalent annual cost basis.

<sup>8</sup> Equivalent annual cost is “the cost per year of owning and operating an asset over its entire lifespan. EAC is calculated by dividing the NPV of a project by the present value of an annuity factor. Equivalently, the NPV of the project may be multiplied by the loan repayment factor.” ([http://en.wikipedia.org/wiki/Equivalent\\_Annual\\_Cost](http://en.wikipedia.org/wiki/Equivalent_Annual_Cost)). Put simply, equivalent annual cost may be thought of as the annual payment on the loans needed to fully finance facilities investments in equal, annual installments over the years in which harvests occur. Like payments on house mortgages or car loans, the annual payments include both interest and principal. For the analysis in this chapter, we calculated equivalent annual costs using the PMT function in Excel.



## CHAPTER 3

# Emerging Technologies in Marine Aquaculture

John Forster

---

*Chapter 3 looks at a spectrum of technologies from which offshore aquaculture will draw as it develops over the next 20 years. First it reviews advances in the three principal disciplines of engineering, and follows this with similar analyses of six key areas of science. The chapter ends with an examination of the forces that drive the human food supply chain, in general, and speculates on how marine aquaculture might respond to them in future decades.*

### Introduction

All farming, be it on land or in water, draws from an amazingly wide range of engineering and science disciplines in order to deliver wholesome food to the end consumer (Table 3.1). Farming is a synthesis of all that is known at a point in time about the animals and plants that humans cultivate and process into products that meet consumers' needs. Cultivation of living things tests man's grasp of biological, physical, and environmental science in a way that few other activities do. So it is reasonable to expect that advances in all of these disciplines in the years ahead will apply also to aquaculture, or the cultivation of living things in water. Advances will lead to improvements in efficiency and even to achievement of hitherto unattainable goals. What follows is a discussion of these disciplines and the significance that technological developments within them could render for open-ocean aquaculture in the future.

### Marine Engineering

Working offshore is something for which man is ill-adapted. To do so, it is necessary to provide boats equipped with a variety of specialized equipment or to provide air-breathing humans the means to operate under water. Working offshore is therefore expensive and inherently dangerous. But advances in marine engineering in recent years have greatly increased the range of things that can be done at sea and promise even more. It would probably not be overstating the case to say that without such advances, offshore aquaculture would not be possible.

Resources from three engineering disciplines must combine to provide the platform from which offshore farmers can operate. Offshore containment systems depend upon suitable structural design and choice of materials. Operations offshore depend upon adequate mechanization of key tasks to minimize the amount of time people must spend in an inherently hostile environment. And there is a need for continuous monitoring of key environmental conditions and livestock behavior to assure optimum efficiency and livestock health.

**Table 3.1. Engineering and science applications in aquaculture.**

<b>Engineering</b>	a) Structures and materials	Containment systems Mooring systems Nets, ropes and lines
	b) Mechanical	General mechanization Underwater operations Feed storage, handling and distribution Net cleaning and anti fouling Fish handling and grading Product processing
	c) Electronics	Monitoring Remote control Security
<b>Science</b>	a) Environmental sciences	Site characterization Weather and ocean state forecasting Monitoring methods Beneficial waste assimilation (polyculture)
	b) General culture biology	New species research and evaluation Broodstock and egg supply Larval rearing Grow-out to harvest
	c) Nutrition	Definition of nutritional requirements Raw material processing Feed formulation Feed manufacture New raw materials
	d) Health management	Diagnosis Vaccines Medications and chemotherapeutics Probiotics
	e) Genetics	Selective breeding Hybridization Polyploidy Gene transfer
	f) Food science	Mechanized processing Packaging Improved shelf stability Byproduct utilization

### Structures and Materials

Containment of livestock is as fundamental to aquaculture as it is to agriculture. Today, most marine aquaculture takes place in protected coastal areas, where benign conditions make it possible for man to provide containment with the structures and materials presently available. But farming in open-sea conditions presents a greater challenge, and there are now numerous research programs in progress, prototypes under test, and early commercial applications under evaluation that promise progress.

Designs of open-sea containment structures must achieve utility at an acceptable cost. Depending on the specific location (see Environmental Sciences section, following), some present designs employ a floating collar that is flexible or strong enough to withstand rough sea conditions and from which a containment net is hung (see pictures 1, 3, 10 in Figure 3.A1). Other structures are designed to avoid heavy seas by being partly or fully submerged, either permanently or as an avoidance procedure (see pictures 4, 6, 8, and 9 in Figure 3.A1; see also Loverich and Forster, 2000). Materials employed include steel, aluminum, PEH plastic, rubber, and a variety of synthetic materials used in various netting and rope products. The latter include Spectra® and Dyneema® high performance polyethylene fibers that are claimed to be fifteen times stronger than steel on an equivalent weight basis and are used, for example, in Ocean Spar Technology's SeaStation® cage (see picture 8 in Figure 3.A1).

Perhaps the biggest debate in the offshore aquaculture community, presently, centers on the utility and accessibility of surface containment structures that must then be able to survive heavy seas, versus the elegant solution that submergence provides to the problems of surface disturbance, albeit at the expense of more difficult access. It is a debate that is likely to continue for years with a variety of hybrid solutions being proposed and with recognition of the idea that no single design is likely to be right in all circumstances. However, it does seem likely that with the development of ever-more elegant techniques for monitoring and operating offshore systems remotely (see Electronics section), submerged containment methods will eventually dominate the market.

In either case, design is also driven by the necessity to assure that livestock are contained securely and that would-be predators are deterred. Already, designers have a considerable range of quite adequate materials from which to choose, and new fibers (referenced above), new methods of making them into netting, and new combinations of materials—such as plastic coated steel—promise to provide even greater reliability at comparable or lower cost. There is no obvious barrier to the development of ever-more effective containment systems, and with efforts ongoing in several parts of the world, such development is expected to keep pace with or lead the development of the industry itself.

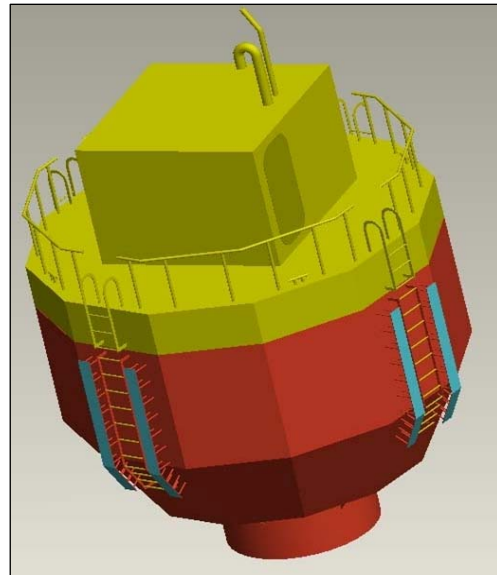
### Mechanization

All farming requires that the stock are tended and handled at one time or another. Procedures for growing fish, shellfish or seaweeds differ substantially, but they all require initial seeding or stocking of the crop and, sometimes, thinning of individual plants or animals as they grow. All three must also be harvested eventually by removing them from the water and bringing them ashore for processing. Farm production of fish also requires that they be fed, that

any fish that die are removed quickly, and that they can be corralled for bath treatment of possible parasite infestations.

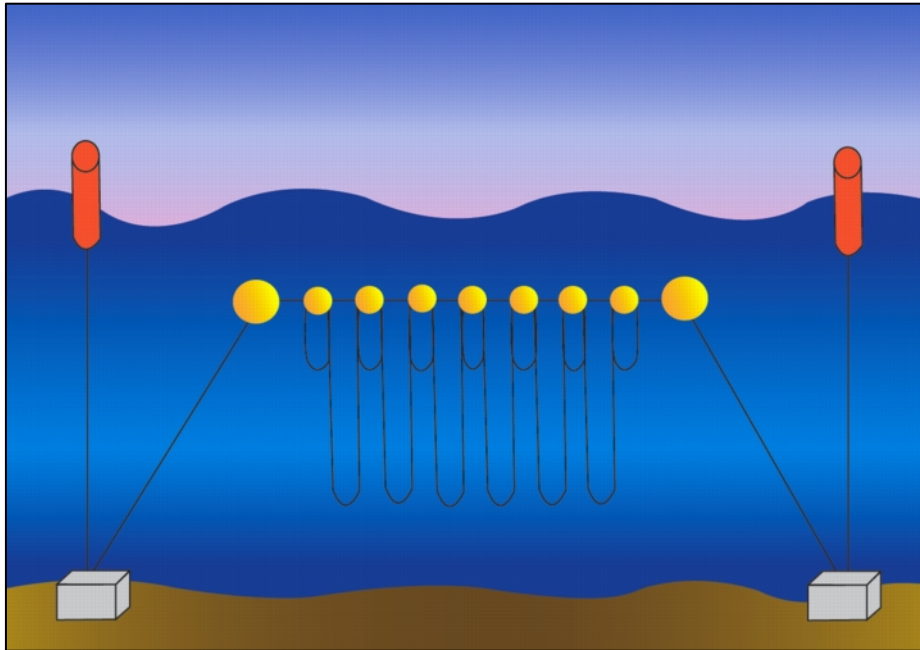
Since offshore farming is still in its early stages of development, mechanization of these procedures is still mostly experimental or relies upon adapting practices and equipment from near-shore farming. Thus, for example, the University of New Hampshire (UNH) is presently developing a feeding buoy for holding and dispensing feed offshore (Figure 3.1). Fish crowding or corraling methods under consideration would use inflatable structures within the containment systems to direct fish to a certain section of the structure so they could be harvested or moved to another container. And methods for the mechanical handling, harvesting, and seeding of rope-grown mussels are being adapted from methods presently being used near shore (Figure 3.2).

**Figure 3.1. Prototype offshore fish feeder and drawing of 20-ton commercial design.**



Source: University of New Hampshire Atlantic Marine Aquaculture Center

**Figure 3.2. Schematic of offshore longline mussel culture.**



Source: University of New Hampshire Atlantic Marine Aquaculture Center

It is neither necessary nor possible to envision the full breadth and range of mechanical handling systems and devices that will be developed in the years ahead. Two things seem certain however. First, large-scale offshore farming will not be possible unless all or most of the critical stock and materials handling procedures are mechanized. Second, as with all mechanical handling systems, the range of engineering tools available to inventors is as varied as the range of skills and talents of the inventors themselves. One only has to look at the range of tools and machines that have been invented for terrestrial farming to imagine what is possible.

Offshore, such machines will be operated from specially built workboats and, in some cases, may be remotely controlled, self-powered, and/or submersible. An example of the sort of device that will almost certainly be developed soon, but which is not yet available, is a remotely operated net cleaning device that will continuously track across the net panels, cleaning as it moves. Another example is a fish corralling system that will exploit specific behavioral traits of different species being grown. Everything that will be done on offshore farms in the future is susceptible to mechanization in one way or another, and there is no reason to suppose that the need for such mechanization will create a serious barrier to progress.

### Electronics

Just as modern electronic and communications technology has revolutionized almost all manufacturing and agricultural processes, so too will it be integral to almost all aspects of offshore farming. Within the next decade, remote monitoring of most aspects of an offshore farming operation should be possible. Real-time video, data from chemical and physical sensors, and readings of high definition Global Positioning System (GPS) coordinates will allow operators to track all key performance parameters and to control some of them from shore-based

or ship-based offices. There are two primary challenges, however. First, though the underlying technologies are already well advanced, applying them in the harsh marine conditions that will be part and parcel of offshore farming will be demanding. In many cases, it may call for levels of robustness and reliability that will require specific adaptation. Second, in caring for livestock, constant observation is critical. Remote video offers an obvious way of doing this, but it depends upon good underwater visibility. Acoustic Doppler methods have been used as an alternative where visibility is poor, and UNH is experimenting with methods whereby individual fish are tagged with radio tags so their movement can be continuously tracked. By accurately observing the location of a few individuals in a population, it may be possible to make judgments about the population as a whole. Nor is it too remote a possibility that such tags could one day be used to monitor physiological functions as well as location, thus providing managers with real-time information about respiration rates, levels of stress hormones, and more. As with other engineering aspects of offshore farming, there are no obvious barriers to monitoring needs, while the possibilities appear to be almost limitless.

### **Environmental and Biological Science**

Aquaculture, like agriculture, draws on numerous branches of the environmental and biological sciences to meet its needs. All of them have been subject to rapid advance in recent years and promise more in years to come. For this reason, it is a mistake to judge aquaculture based on its recent history, or to propose prescriptive solutions for its further development. For example, there has been a tendency in recent years for people to opine unfavorably on the sustainability of certain aquaculture practices, such as the feeding of feeds containing fish meal to carnivorous fish, or on concerns about the discharge of nutrients into marine waters. But since aquaculture is still a work in progress its sustainability should not just be judged on the status quo. The past 20 years have seen great progress in everything from the engineering of fish containment systems to the routine application of vaccines for the control of fish disease. The next two decades promise more. Like many businesses, aquaculture will adapt through technical advances to the selective pressures of commerce. Some of the advances that seem most likely to occur in the immediate future are discussed below.

#### *Environmental Sciences*

Environmental sciences are critical to offshore aquaculture in two ways. First, it is necessary to characterize farm locations in terms of weather, potential sea states, current profiles, and water quality, so that equipment and operating procedures can be specified appropriately. Ryan (2004) proposed a method for doing this for fish farm sites off the west coast of Ireland based on expected wave height. Four site classes were proposed, ranging from Class 1 (sheltered) with significant wave heights of <0.5 meter (m) to Class 4 (exposed) with significant wave heights of 2 to 3 m. Though this is helpful as far as it goes, it does not take into account the frequency with which such wave states occur or the expected strength of currents, which can be magnified by high winds. Equipment that might be specified to work in constant or semi-constant ocean swell, as occurs off the coast of Ireland, may be quite different from equipment needed in locations where the sea state is benign most of the time but where there are occasional, extreme storms.

This highlights a basic rule in marine fish farming; namely, it is always necessary to undertake a detailed physical characterization of a specific location before farming is contemplated. Oceanographic science provides numerous tools to help in such work, including GPS mapping methods, acoustic Doppler current profilers, satellite imagery, and a substantial body of documented oceanographic and meteorological knowledge. All of these tools can be used by fish farmers for site characterization, with the expectation that even more sensitive and sophisticated tools will become available in the future. Once in place, offshore farms can then draw on a formidable array of weather forecasting tools and reports in order to plan operations and/or an avoidance strategy if severe weather is predicted. Hurricane forecasting, for example, now provides up to five days' notice of a possible threat, providing sufficient time to implement contingency plans.

Next, the impact of operations on the chemistry and biology of the chosen area must be monitored. During the last 20 years, studies on the impacts of solid and soluble wastes from salmon farms in Norway, Scotland, Canada, and the United States, and from sea bass and sea bream farms in the Mediterranean, have resulted in a substantial body of knowledge (EAO, 1997; NOAA, 2001; SAMS, 2002; European Commission, in progress). The primary conclusions are that, in most cases, effects on water quality are minimal, while effects in terms of sedimentation and organic enrichment of the seabed under fish farms are directly linked to site conditions and management. In fact, it has been learned that determination of excessive build-up of sediments under fish farms is the most sensitive and reliable indicator of when "carrying capacity"<sup>1</sup> of the local environment may become overused. These studies also predict that carrying capacity of offshore aquaculture locations will be greater than inshore locations, due to greater water depth and stronger or more consistent currents.

Techniques and instrumentation for monitoring the biological and chemical impacts of offshore aquaculture may be expected to become more accurate and better targeted as the industry develops. All of the analytical techniques originate in other branches of research; their appropriate and targeted application is key to designing monitoring programs that yield useful information at a reasonable cost. As knowledge increases, remote, continuous monitoring of some key parameters may become possible, with data being uploaded to websites for review by the public and/or regulatory agencies.

Environmental concerns about shellfish farms are less, since no feed needs to be provided for the stock. Instead, creatures such as mussels and scallops obtain their food by filtering microscopic plants from the water in which they live. However, the potential to over-graze a body of water exists if too many shellfish are held in one place, and accumulation of shell and other biological material from organisms that colonize the farm structures can occur on the seabed. Farming of seaweeds presents even less concern, because these plants require only sunlight and nutrients drawn from the surrounding water to grow. In fact, when grown in combination with finfish, seaweeds might be used to recover or recycle some of the wastes those fish produce.

---

<sup>1</sup> Carrying capacity is used in this context to denote the capacity of a given body of water to assimilate waste products from aquaculture facilities without significant adverse effects.

This introduces the idea of what is known in agriculture as integrated farming. Sometimes it is called “polyculture,” and it refers to the culture of more than one organism, each one of which—by feeding at a different trophic level—helps to maximize the efficiency with which nutrient inputs to the system are used (Chopin, 2005). Such multiple cultivation may take place in the same container (polyculture) or it may be performed in a series of containers (integrated aquaculture). Either way, it is particularly well-suited for aquaculture, where nutrient wastes are rapidly dispersed and become immediately available to the plants that use them. In terrestrial farming, this can only be accomplished by the physical removal of wastes and subsequent spraying on fields. By contrast, aquatic plant production can utilize the confined culture of a seaweed species or the unconfined, natural enhancement of phytoplankton, which, in turn, can become food for confined bivalve shellfish. The respective merits of each are determined by crop value. This evolution of aquaculture promises to become extremely important over the long term.

### General Culture Biology

Perhaps the most dramatic, or at least visible, progress in aquaculture over the last 30 years has occurred in the field of general culture biology. Advances have included the selection and domestication of new species, development of hatchery rearing methods for species that have delicate, fragile larvae with complicated life stages, and establishment of breeding stocks of important species that provide the basis for year-round production and genetic improvement. It is expected that such progress will continue. In particular, advanced hatchery and breeding techniques will be applied to an ever-widening range of species. Though many will be found not to domesticate well, some will become substantial aquatic farm species in the same way that salmon, tilapia, shrimp, mussels, and scallops have become important in the last 30 years, while others may find roles as niche market species.

From the market’s point of view, there seems to be a major opportunity for farmed, white-fleshed, marine fish that can provide comparable value to farmed salmon. Species such as cod, halibut, red drum, cobia, black cod, snapper, and some tuna have promising attributes, and they are the subjects of research and/or small-scale commercial production in several countries. Which of them might become candidates for large-scale offshore aquaculture depends on market acceptance and the costs of farming them. Simplicity in the hatchery, fast growth, responsiveness to farm conditions, and efficient growth on low-cost feeds are all attributes that lead to low-cost farming—an essential prerequisite to providing affordable seafood. Since salmon farming has proved this possible, salmon provides a good benchmark against which the potential of new species can be measured.

### Nutrition

Most captive finfish must be provided with food, therefore nutritional science is another critical discipline in aquaculture. It is an area where some of the most important developments may occur in years to come, especially since fish feed researchers and manufacturers can draw upon a huge body of knowledge in terrestrial animal nutrition. As is true in the farming of chickens or pigs, the feed in fish farming can account for over 60% of total costs. Therefore, better and lower cost feeds will render a large impact on the economic competitiveness of the industry. Extensive research is already progressing in several key areas, including:

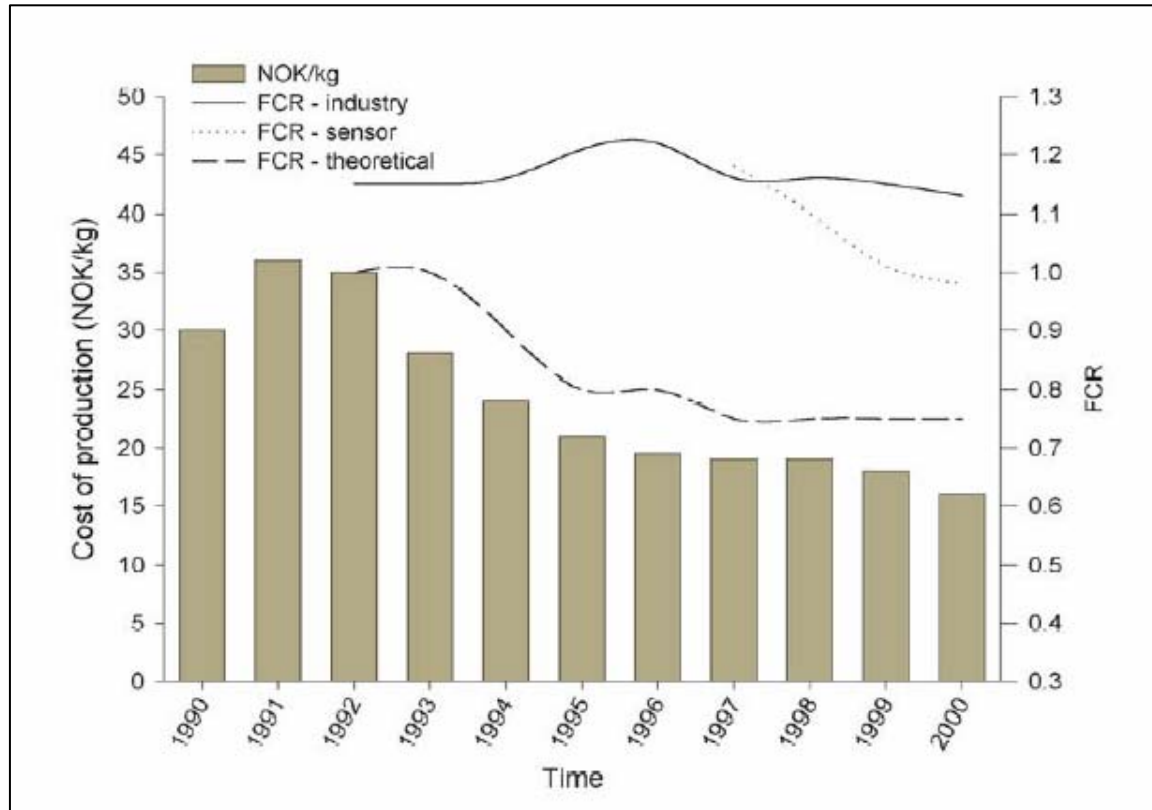


- Better definition of the nutritional requirements of different species, especially amino acid and lipid needs, since they have a direct bearing on what raw materials can be used.
- Identification of alternative raw materials that can be used to replace fish meal and fish oil in feeds. These may be processed wastes from other industries, such as meals made from chicken processing waste or fermentation byproducts. Or, they may be agricultural raw materials such as soybean (United Soybean Board, undated) and canola, which may themselves be genetically improved to increase nutritional value to target species. This is discussed in more detail in Chapter 6.
- Processing of raw materials to make them suitable for fish. Some potentially suitable plant materials, such as soybean, contain anti-nutritional components that must be denatured by cooking or other treatment prior to their use in fish feeds.
- Formulation of feeds so that nutritional requirements of target species are more completely met. This is especially important for brood fish, in which egg quality can be compromised by inadequate nutrition, and in fish that through genetic improvement grow very quickly—thereby imposing extra nutritional demands.
- Milling of raw materials into water-stable rations that are appetizing to fish. Usually this requires some form of pelleting; for example, cooking extrusion, which produces water-stable feed pellets to which high levels of fat can be added. Extruded feeds have become widely used for many species in recent years, especially for salmon, and have contributed greatly to improvements in feeding efficiency.
- Better definition and control of feeding practices that optimize feed intake and minimize waste.

The success of this research will be measured mostly in terms of cost per unit of weight gain by the animals in culture. Salmon farmers, for example, who have pioneered much of what is now known about net-pen aquaculture, have been able to reduce the food conversion ratio (FCR) from about 2:1 some 20 years ago to an industry average of about 1.3:1 today. This represents a substantial savings in cost and reduction in wastes discharged. Further gains will occur in the years ahead, with an anticipated theoretical minimum of about 0.7:1 to 0.8:1 (Figure 3.3).

### Health Management

A basic rule of animal or plant husbandry is that maintaining a good rearing environment will minimize health problems. This idea is often thought of today in terms of general animal welfare, with the clear underlying principle that if the creatures in care are kept clean, fed well, and not overcrowded they are more likely to be healthy. As aquaculturists learn more about basic welfare for the species they grow, it is expected that health problems will be minimized. This is especially likely to be the case in the offshore environment where water quality is good and conditions more stable than inshore, and where rates of water exchange through the culture systems will be higher.

**Figure 3.3. Gains and projected gains in food conversion rates (FCR) for salmon.**

Source: Blyth and Dodd, 2002

However, parasitic infestations and bacterial and viral diseases are a constant threat in all forms of husbandry, making an active livestock health management plan mandatory. In aquaculture, major advances have been made over the last 30 years in techniques for diagnosing health problems and in methods of dealing with them. These include better diagnostic tools (especially for viruses), improved understanding of the immune systems of the animals in culture, development of vaccines (especially against bacterial diseases in fish), and the advent and registration of new and better chemotherapeutants. On a parallel track, regulations governing the movement and sale of live aquatic organisms have been tightened, in part at least, because disease screening techniques have improved.

One of the most dramatic areas of improvement has been in the field of fish vaccines where, again, the salmon farming industry has pioneered the way. For example, until the early 1990s, two bacterial diseases, *Vibriosis* and *Furunculosis*, constantly caused problems in farmed salmon and in some other species too. Though vaccines had been developed, they were not very effective until it was found that they should be injected into the body cavity of juvenile fish as an emulsion in vegetable oil. This discovery spurred rapid development by pharmaceutical companies, such as Alpharma and Novartis (Aquahealth), and vaccines against at least six fish diseases are in use today. The salmon farming industry in Norway, for example, now uses less than 0.5% of the medicine required to treat these diseases than it did 10 years ago (Ludvigsen, 2003). Vaccines are presently under development against common parasitic infestations and

viral diseases in several species of fish in different countries. They will provide future offshore aquaculturists with powerful new health management tools. Oral vaccines, in particular, if they can be developed, would greatly simplify and extend how vaccines are used, and in this aquaculture can draw on scientific advances elsewhere.

### Genetics

Data in Watts and Kennet (1995) show how the performance of broiler chickens was improved over 60 years between 1935 and 1994 (Table 3.2) when the key production parameters of finished weight, FCR, and growth rate improved by 1.7, 2.3, and 2.5 times respectively. Improved genetics is generally considered to have contributed 80% of these advances.

**Table 3.2. Improvements in broiler chicken growth rate and feed conversion rate.**

Year	Weight (kg)	FCR	Age marketed (wks)
1935	1.27	4.4:1	16
1950	1.36	3.5:1	11
1975	1.70	2.0:1	8
1994	2.11	1.9:1	6.5

Source: Watts and Kennet, 1995

Arguably, aquaculture is at least 50 years behind the broiler industry, so this example provides insight into how dramatically aquaculture could advance in the years ahead. Eknath et al. (1991) showed that some improvement has been achieved in salmon already, versus species new to aquaculture - where first generation progeny are from wild stock. It is highly probable that genetic gains similar to those achieved in terrestrial animals will be possible with aquatic livestock, especially since their high fecundity allows for increased selective pressure. Also, modern genetic techniques, such as the use of genetic markers in conventional breeding programs, can be used to focus effort on specific traits.

Alternative genetic tools are available too. Triploidy, where a fertilized egg is induced by a simple temperature or pressure treatment to retain an extra set of chromosomes, is used in some species to produce non-reproductive stocks. For example, triploid rainbow trout eggs are commercially available and are used in several state recreational fishery programs because fish from them do not mature sexually and, therefore, can reach large, “trophy” sizes. Triploidy, a natural phenomenon but not self-sustaining in nature because the progeny cannot breed, is now the subject of research with several species that are of interest to aquaculture (Troutlodge Inc., undated).

Another technique that might be used to improve aquatic stocks for farming is the transfer of genes between species to create “transgenic” stock, or genetically modified organisms (GMOs) as they have become commonly known. A frequently cited aquacultural example is a genetically modified Atlantic salmon developed by a company called Aqua Bounty Technologies Inc. Due to the transfer of genes from Chinook salmon and ocean pout, this transgenic salmon produces a higher than normal amount of growth hormone and will grow four to six times faster than genetically normal salmon (Aqua Bounty, undated).

One concern about genetically improved aquaculture species and, especially, transgenic organisms is that they may become feral in the marine environment. Triploidy, and other techniques to make such improved animals non-reproductive, would mostly overcome such concerns, because the animals could not then establish a population or interbreed with wild stocks. But this is still an area where caution and further research are needed. Equally, however, GMO research is also an area that may provide huge benefits, like those it has already conferred in terrestrial crop farming, and must be given consideration in any long-term evaluation of aquaculture's potential.

### Food Science

This subject embraces a wide spectrum of technologies that can be applied post harvest to assure quality and safety, to improve efficiency, and to add value to the finished product. Procedures for post harvest handling of seafood to assure best quality are well understood and there does not seem to be much scope for new technology *per se* to add materially to what is known. The key is to ensure that these procedures are always followed and a number of quality assurance programs are available to facilitate this, including the U.S. Food and Drug Administration's (FDA) Hazard Analysis and Critical Control Point (HACCP) program and the International Standards Organization (ISO) quality assurance certification programs. In general, since the harvesting process for seafood raised on farms is inherently more controlled than for wild-caught seafood, such control programs are more easily applied to aquaculture products.

Mechanization of processing procedures is a field where there is already considerable innovation but, also, opportunity for substantial efficiency improvements. This is particularly important in the United States, where the higher cost of labor makes manual processes noncompetitive with those of lower-wage economies. For example, a primary reason for the initial competitiveness of Chilean-farmed salmon fillets in the United States during the late 1990s was that the cost of doing all the work in Chile to produce a "pin bone out, skinless fillet" was much lower than in other major producing countries such as Norway and Canada (Johnson, 2003). Today, the development and application of filleting, skinning, and pin-boning machines is narrowing the competitiveness gap. The trend towards mechanized processing will continue, especially for fresh seafood products, because of the advantages in producing such products close to their market.

Consistency of supply of farm-raised products is another advantage, enabling processing plants that invest in expensive equipment to be assured of its efficient use. A notable example of such mechanization and efficiency is the U.S.-farmed catfish processing industry, where plants are able to produce a wide variety of processed, value-added catfish products despite having to do so within the high wage U.S. economy.

Improved shelf stability of seafood products is another area where technological advances will affect the competitive dynamics of the industry. Freezing, canning, salting, smoking, vacuum packing, and retort pouching are all techniques in common use today. However, they all change the product to a greater or lesser degree, and with it, the perception of quality. Fresh seafood still carries a cachet that few shelf-stabilized products can match. Several techniques are used today to extend the shelf life of fresh foods, all designed to kill or inhibit spoilage bacteria. They include ozonation of processing wash water and ice, modified

atmosphere packaging, and irradiation. The latter has been approved by the FDA for meat and poultry but not yet for seafood.

An underlying assumption, or at least one that is not often questioned, is that the market premium for fresh seafood will continue, and this will drive further developments to extend the shelf life of fresh products while constraining producers who find it difficult or expensive to supply fresh products. Presently, for example, the U.S market for fresh tilapia fillets is supplied almost exclusively from Central and South America, because airfreight is available at a reasonable cost. On the other hand, Chinese farmers, who could otherwise be extremely competitive in this market, are restricted to shipping frozen tilapia fillets because the cost of airfreight from China to the United States is prohibitive. It is easy to see how changes in market preference toward frozen seafood, or shelf-life extension of fresh products that would allow sea freight to be used, or changes in the cost of airfreight, could change competitiveness in a global market. It is expected that producers will constantly probe for advantages in this area. The competitiveness of future U.S producers, therefore, will constantly be challenged and will demand international levels of productivity and efficiency in all parts of the business.

An aspect of the seafood industry where aquaculture is not yet particularly efficient is its use of byproducts from processing. And yet, due to the consistency and predictability of supply, plants that process aquaculture products have an intrinsic advantage over those that process wild-caught products. There are a number of processing technologies in use for converting fish and shellfish waste into marketable products (Johnson, 2003). Some of these processes involve grinding and cooking of raw fish and offal, drying of raw material, or the hydrolysis of fish protein through some form of enzymatic action. Outputs from these processes include pharmaceuticals and nutraceuticals, industrial compounds, food products (oils, gelatins, flavors, and extracts), feeds, and fertilizers (Table 3.3). Some products are of sufficient value that they may, in fact, become primary targets.

The key to successful byproduct recovery is to have a consistent supply of raw material in a volume sufficient to justify investment in the processing equipment and management of the byproduct operation. Currently, most aquaculture activities are too small to meet the volume criteria, and disposal of processing waste represents a cost rather than a source of income. Realistically, this is likely to remain the case for some time to come, but clearly it represents upside potential for the industry and offers one example of the benefits that derive from larger-scale production.

### **Long-term Considerations**

The long-term direction and future of offshore aquaculture will be governed by forces that drive the food supply chain in general. These forces include both threats and opportunities. Tables 3.4 and 3.5 summarize aspects of a future competitive environment that seem especially likely to affect the seafood industry.

**Table 3.3. Seafood industry byproducts.**

<b>Industry</b>	<b>Product</b>	<b>Application</b>
Aquafeed	Fish hydrolysates	Feed additives
Animal Feed	Co-dried products	Flavorants and attractants
Pet Feed	Fish hydrolysates Fish oils Natural pigments	Protein supplements and flavorants Fish oils Antioxidants and pigment enhancement
Organic Food Industry	Fish fertilizers	Plant nutrition
Nutraceuticals	Fish oils Peptides Chitin Chondroitin sulphate	Health promotion
Industrial Compounds	Chitin Gelatin Enzymes	Paper making Cheese processing Water purification
Human Food	Fish oils Gelatin Seafood derivatives	Health foods Kosher and Hatal gelatins Flavorants and thickeners
Pharmaceuticals	Specialty products	Drug delivery Anticoagulants Arthritis, cancer, and other treatments Photoelectric applications Biotechnology

Source: Johnson, 2003

The balance between human needs and the Earth's capacity to supply them is delicate and subject to continuous change. Human needs change in response to numbers of people, perceptions of preference, and market forces, while understanding of capacity changes in response to new technology and new appreciation of the ecological footprint that activities impose. Most animal agriculture, as it is practiced today, represents an ecological extravagance that man embraces because meat is a preferred food item and, in many cases, provides nutrients that would not be available in adequate quantities from an all-vegetable diet. Until now, it has also been an affordable extravagance, since the number of humans has been moderate and a high level of meat consumption has been confined to a relatively small proportion of them. But trends suggest that this may not be the case much longer (Figure 3.4). Since human consumption of meat is driven both by an increase in the human population and its overall level of affluence, how long will it be before resource pressures impose limits on such growth? And, what will happen when they do?

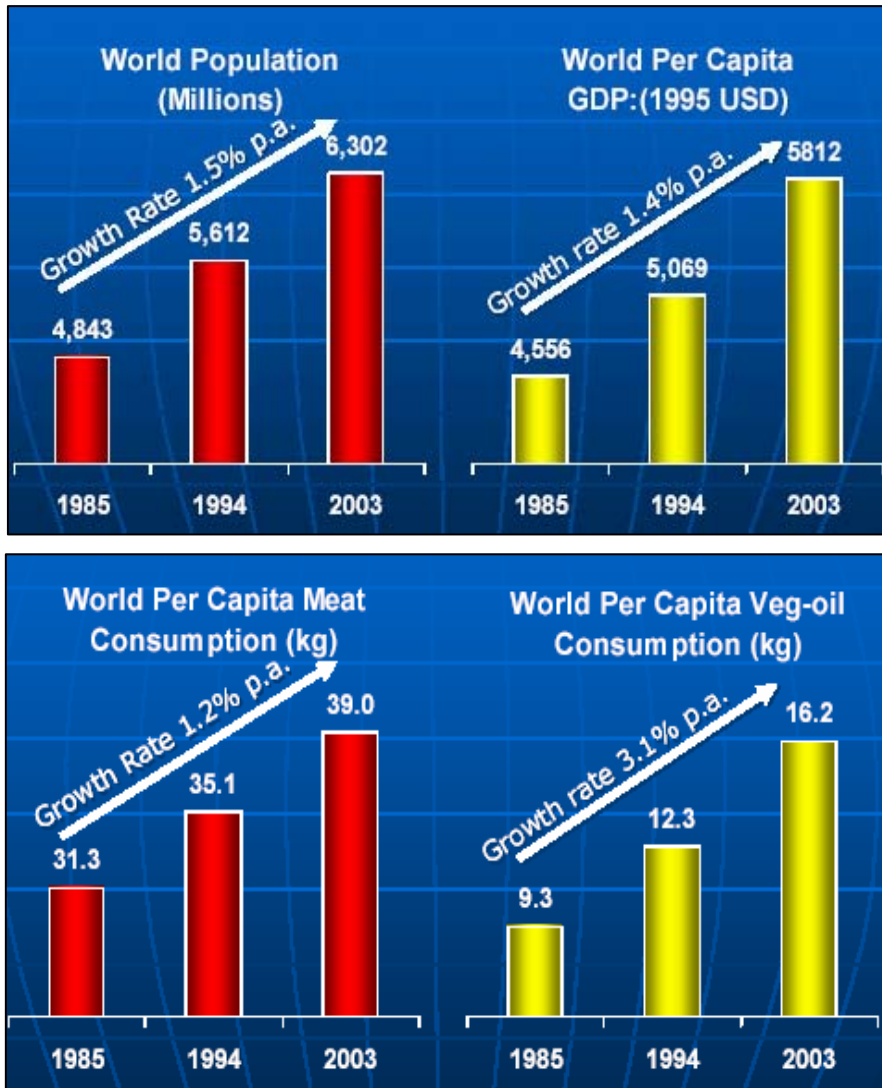
The threats (Table 3.5) are all consequences of such resource pressures or responses to them. For example, increasing acceptance of simulated meat made from textured vegetable protein is a likely response to rising costs and, therefore, prices for the real thing. Similarly, vegetarianism, or at least a reduction in per-capita consumption of meat, is another response (the Atkins diet notwithstanding), especially in the United States where levels of meat consumption at 98 kg per capita per year is 2.5 times the world average, and dietary guidelines are urging general moderation.

**Table 3.4. Long-term threats and possible responses or consequences.**

<b>Threat</b>	<b>Impact</b>	<b>Response / Consequence</b>
Higher energy costs	Will affect all parts of the business especially marine mobility	Mechanization and remote monitoring and control (see Marine Engineering section of this chapter).
Feed raw material shortages	Feed cost increase	Assuming feeds can be formulated from a variety of feed ingredients (see Chapter 4) fish farming will be no more affected by feed cost increases than other animal farming industries. In fact, it may have an advantage because some fish may use feed more efficiently than their terrestrial counterparts (Forster and Hardy, 2002).
Development of synthesized or artificial foods; e.g., artificial crab meat	Foods made from single cell proteins, textured vegetable proteins or, possibly, cultured muscle tissue could be a competitor.	Assuming such products are safe, are effective imitations, and are cost competitive, the only response can be to emphasize the benefits of “the real thing.”
Omega 3 fatty acid supplements	Weakens a key selling point for seafood, i.e. health.	There are other, though less unique, benefits of seafood that can be promoted but fish oil pills and fortified foods are already being sold. In the long term, seafood must sell because it is good tasting food not because it is “medicine.”
Vegetarianism due to concerns about animal welfare or the ecological cost of humans as carnivores	Reduced consumption of animal proteins	Animal welfare concerns may be partly addressed by good farming practices and humane slaughter methods, which are more easily demonstrated for aquaculture compared to commercial fishing. Also, the ecological costs of farmed seafood may be less than those of producing meat on land, which would give aquaculture a competitive advantage

Aquaculture offers another response. By finding ways to use a greater proportion of the Earth’s surface for food production, and by growing species that may be more efficient in converting resources into animal tissue, aquaculture promises to change how the Earth’s capacity is presently understood. The opportunities and possibilities identified in Table 3.5 touch upon this promise. It is impossible to know how it will actually develop. Other factors besides simple resource considerations will determine the ultimate outcome. But insofar as the future will be driven by the balance that is struck between human needs and the Earth’s capacity to supply them, aquaculture in the oceans seems certain to become increasingly important.

**Figure 3.4. World trends in population, gross domestic product (GDP), meat and vegetable oil consumption.**



Source: Bunge, undated



**Table 3.5. Long-term opportunities and possibilities.**

<b>Opportunity</b>	<b>Impact</b>	<b>Response / Consequence</b>
Increased purchasing power in developing countries	As China, India and other Asian countries modernize, their people will seek to upgrade their diets. This will increase demand for what may be a limited supply of some products.	Though offshore aquaculture will seek to expand internationally to meet this demand, it may be difficult to keep up. Since the United States can be a competitive producer, a homeland industry can benefit from market strength and help to assure supply to U.S. consumers.
Cold-blooded creatures that do not maintain body temperature or have to resist gravity are more energy efficient than warm-blooded terrestrial animals	Less food energy will be needed by aquaculture to produce an equivalent amount of animal protein. And less carbon dioxide or methane will be produced as waste products.	In an energy-limited world, this may be a key long-term advantage for aquaculture. It remains to be thoroughly examined and quantified by detailed input/output analysis, but there are good theoretical grounds to believe it will be found to be real (Asgard et al., 1999). Moreover, a case may be made that farmed seafood provides a better nutritional return for the inputs invested than do farmed mammals and birds.
Nutrient recycling	Nutrients discharged as wastes may be taken up and used by the marine food chain more effectively than nutrients from terrestrial animals that may overload localized terrestrial capacity. More aquaculture could, therefore, lessen impacts on land, freshwater aquifers, and near-shore marine waters.	This also needs to be demonstrated but there are theoretical grounds for believing it could be true. Nutrients from offshore aquaculture will be widely dispersed quickly, thereby becoming available to phytoplankton over a large area receiving, proportionally, a much greater amount of sunlight than nutrients sprayed on fields.
Polyculture – the controlled recovery of nutrients by cultivating more than one organism	This will have the same impact as nutrient recycling above except that the “take-up” will occur by other farmed organisms that may be grown and harvested at a profit (see Environmental Sciences section of this chapter).	The most direct way to accomplish this is through the culture of seaweeds for food, chemicals or biomass. Indirect recovery is also possible by cultivating filter feeding shellfish that feed on enhanced phytoplankton stocks that will develop in the vicinity of a fish farm.
Synergy with wave and wind energy systems	More efficient use of the maritime infrastructure is needed for both industries.	Since working offshore is inherently difficult, and therefore expensive, this has the potential to reduce costs. Wave energy systems will also provide protection for aquaculture structures.

Appendix

Figure 3.A1. Open-sea cages: A design history.



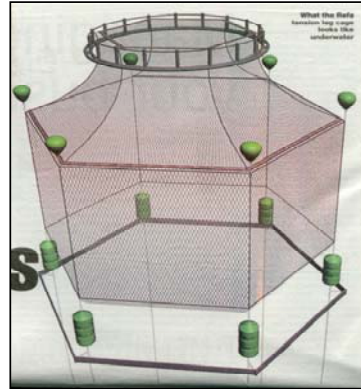
1. Bridgestone cage circa 1986. Non submersible, flexible structure. Still in use and one of the most successful open sea cages to date.



2. Viking Sea Going Farm circa 1988. Relied on strength to withstand ocean forces and failed.



3. FarmOcean semi submersible cage circa 1990. Still some in use but few were sold. Expensive



4. Refamed Tension Leg cage circa 1990. Relies only on floats and lines. Deforms in currents. Used extensively in Italy

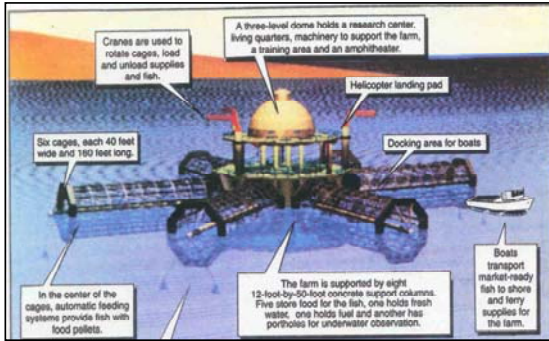


5. Ocean Spar cage circa 1990. Relies on anchor tension to hold shape. Partly submersible but has not done well in really heavy sea conditions.



6. Trident Cage circa 1992. Geodesic design, submersible but with interior single unit net. No longer made or in use.

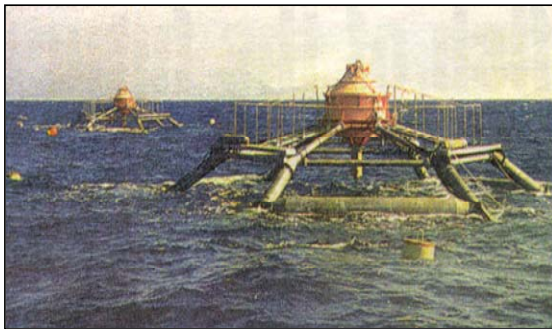
Figure 3.A1 (continued). Open-sea cages: A design history.



7. Seatrek concept cage Circa 1992. Permanently submerged barrel cages. Never built



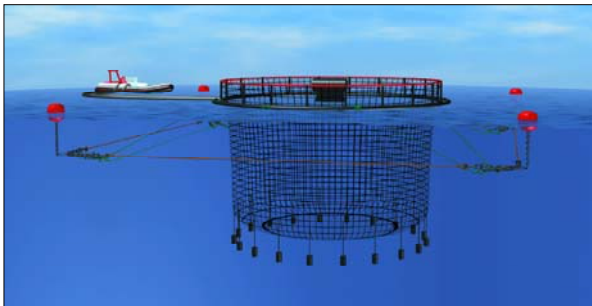
8. SeaStation single spar submersible cage, circa 1992. Fixed volume, tensioned rigging lines to support net, now in service in several countries



9. Sadco Shelf submersible cage, circa 1992. Similar to SeaStation but rigid structure supports net and includes integral feeder. Now in use I several countries.



10. Dunlop Tempest cage, circa 1990. Very similar to the Bridgestone cage.



11. Submersible PolaCirkel cage, circa 1994. Conventional PEH cage that can submerge when rim is flooded. Now in service in several countries

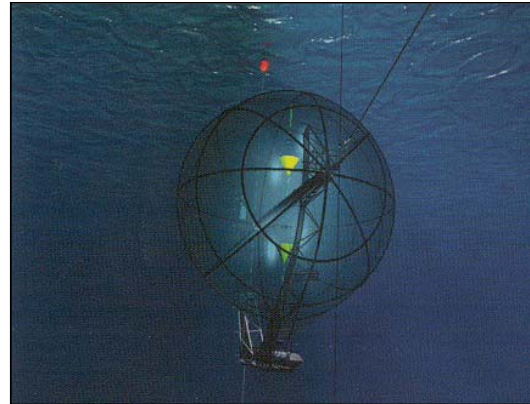


12. Platform cage, Spain, circa 2000. Uses oil field type structure fixed to sea bed for net support

Figure 3.A1 (continued). Open-sea cages: A design history.



13. Ocean going concept cage , Spain, circa 2004. Specially designed for tuna where wild caught juveniles are used



14. Ocean Glob, circa 2004. Norwegian concept cage made with PEH pipe. Yet to be built and tested

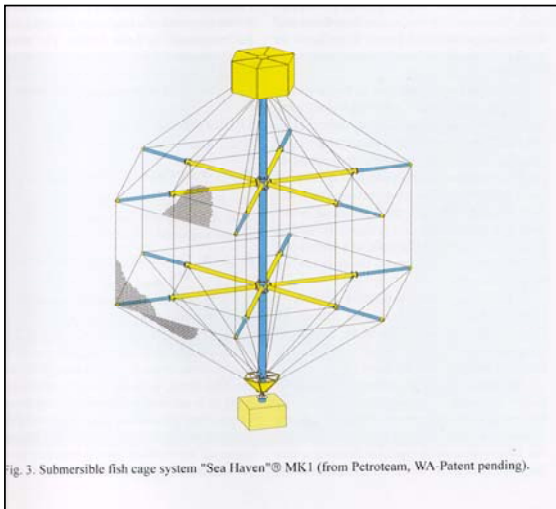
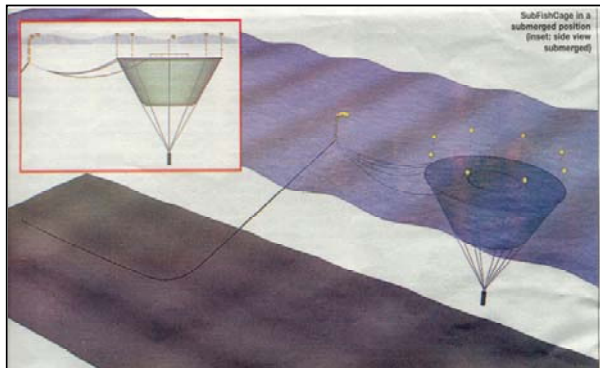


Fig. 3. Submersible fish cage system "Sea Haven"® MK1 (from Petroteam, WA Patent pending).

15. Sea Haven cage circa 2004. Under development in Western Australia.



16. SubFishCage, Europe, circa 2004. Concept cage being designed as part of EU development project

## References

Asgard, T., Austreng, E., Holmefjord I., Hillestad, M., and K. Shearer. 1999. Resource efficiency in the production of various species. *Proceedings of the Second International Symposium on Sustainable Fish Farming*. Oslo, Norway. Nov. 2-5<sup>th</sup> 1997, Publ. A.A. Balkema, Rotterdam.

Aqua Bounty. Undated. [www.aquabounty.com](http://www.aquabounty.com)

Blyth, P.J., and R. A. Dodd. 2002. An economic assessment of current practice and methods to improve feed management of caged finfish in several SE Asia regions. <http://library.enaca.org/Grouper/ResourceMaterials/Grow-out/Feed2003.pdf>

Bunge. Undated. [http://www.bunge.com/US/en/industry\\_information/afoa\\_slides.pdf](http://www.bunge.com/US/en/industry_information/afoa_slides.pdf)

Chopin, T. 2005. “Integrating for Sustainability: Benefits of Fish/Seaweed/Shellfish Farming”. Presentation at symposium on “Farming Ocean Carnivores: The Science, Economics and Politics of Rapidly Expanding Fish Aquaculture.” Meeting of the American Association for the Advancement of Science, Washington, D.C., Feb. 2005.

EAO. 1997. Salmon Aquaculture Review. Environmental Assessment Office, British Columbia, Canada. <http://www.eao.gov.bc.ca>

Eknath, A.E., Bentsen, H.B., Gjerde, B., Tayamen, M.M., Abella, T.A., Gjedrem, T., and Pullin, R.S.V.P. 1991. Approaches to national fish breeding programs: pointers from a tilapia study. *NAGA the ICLARM Quarterly*, April 1991:10-12.

European Commission. In progress. The Meramed Project. <http://meramed.akvaplan.com/>

Forster, J., and R. Hardy. 2002. Measuring efficiency in intensive aquaculture. *World Aquaculture* 32(2):41-45.

Johnson, H.M. 2003. Market Outlook in the International Fish and Seafood Sector. Alternative Products/Uses and Food Safety Issues. Appendix III, Study 2 Achieving the Vision. *Report of the Commissioner for Aquaculture Development*. Ottawa, Canada.

Loverich, G., and J. Forster. 2000. Advances in Offshore Cage Design using Spar Buoys. *J. Mar. Technol. Soc.* 34(1):18-28.

Ludvigsen, S. 2003. “Norwegian aquaculture - potential and challenges.” Speech at seminar hosted by the Brazilian Ministry of Fisheries - Brasilia - 7. October 2003. <http://odin.dep.no/fkd/engelsk/p10001957/p10001958/008031-090031/dok-bn.html>

NOAA. 2001. “The Net-pen Salmon Farming Industry in the Pacific Northwest.” U.S. Dept. of Commerce, NOAA Tech. Memo. NMFS-NWFC-49. <http://www.nwfsc.noaa.gov/publications/techmemos/tm49/tm49.pdf>

Ryan, J. 2004. Farming the deep blue. Bord Iscaigh Mhara (BIM), Dublin, Ireland.

SAMS (Scottish Association for Marine Science). 2002. Review and Synthesis of the Environmental Impacts of Aquaculture. <http://www.scotland.gov.uk/Resource/Doc/46951/0030621.pdf>

Troutlodge Inc. Undated. “Triploids in Aquaculture.” [www.troutlodge.com](http://www.troutlodge.com) (Technical Bulletins)

Watts, G., and C. Kennett. 1995. The broiler industry. *Poultry Tribune*, Centennial Edition, Watt Publishing, pp.6-18.

United Soybean Board, “Soy in Aquaculture Initiative.” <http://www.soyaqua.org/>

## **CHAPTER 4**

### **Future Aquaculture Feeds and Feed Costs: The Role of Fish Meal and Fish Oil**

**Gina Shamshak and James Anderson**

---

*This chapter will explore the important interlinkages between the fish meal and fish oil sectors and the aquaculture industry. Aquaculture has been the fastest growing food sector over the past two decades and this steady and rising growth in the aquaculture sector is forecast to continue into the future (Anderson, 2003). This growth will, in turn, fuel increased demand for fish meal and fish oil. Within the aquaculture industry, small pelagic fish, such as herring, menhaden, capelin, anchovy, pilchard, sardines, and mackerel, are used either whole or are reduced into fish meal and fish oil and used to feed aquaculture species. The dependency of the aquaculture industry on the availability of fish meal and fish oil has raised concern among environmental groups about potentially negative effects on wild fish stocks (Naylor et al. 2000). This dependency also has potential implications for the future growth of the aquaculture industry and the development of an offshore aquaculture industry. This chapter provides an overview of global fish meal and fish oil production. It identifies the main sources, producers, and consumers of fish meal and oil products. The discussion highlights past, current, and future trends in fish meal and fish oil consumption by its two primary consumers: the agriculture sector and the aquaculture sector. Finally, it explores the implications for the future of the aquaculture industry and, in particular, the emergence of offshore aquaculture.*

#### **Introduction**

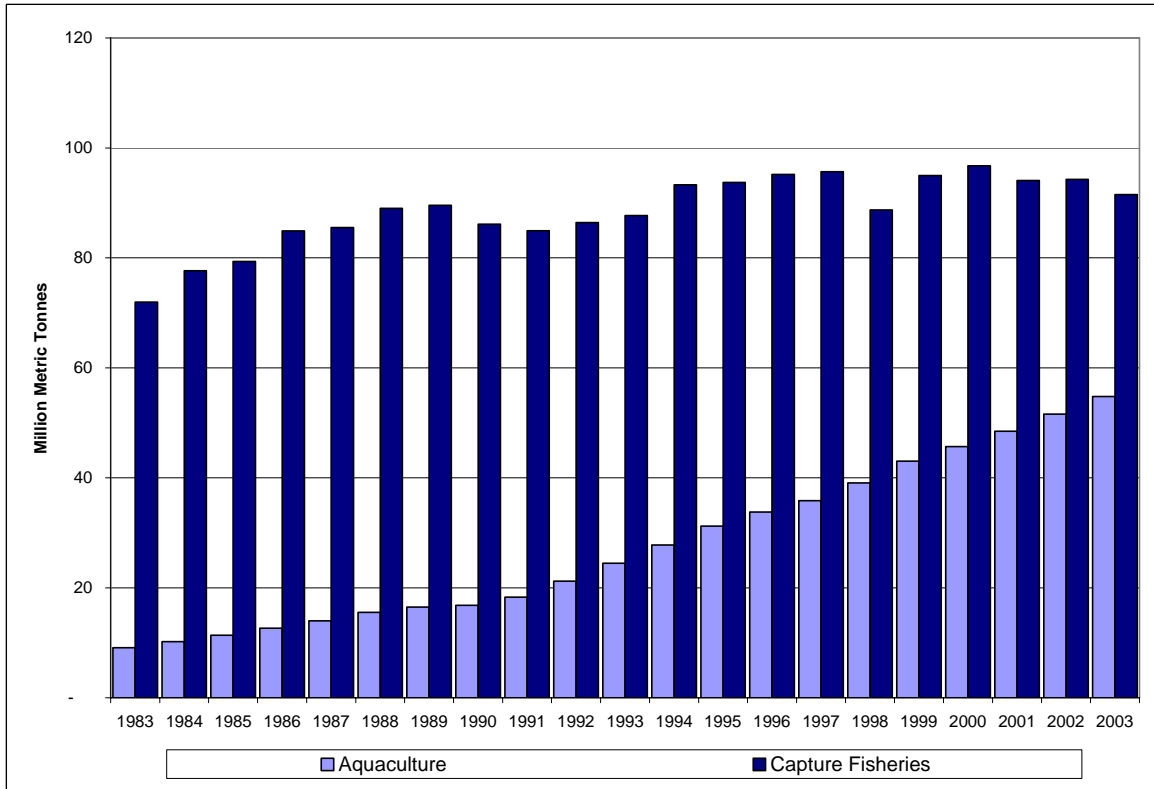
Fish meal and fish oil products are derived from small pelagic species that are not generally used for human consumption. Examples of such fish include: herring, menhaden, capelin, anchovy, pilchard, sardines, and mackerel. These commercial fisheries are often referred to as reduction fisheries due to the steps by which the harvest is processed, or reduced, into a final product. Early maturation and high fecundity often characterize the species that comprise reduction fisheries. In addition, these species are known to be sensitive to changes in environmental conditions, which lead to uncertainty in stock forecasts. The major reduction fisheries are located off the coasts of Peru and Chile and in the North Atlantic, North Sea, and Baltic Sea.

#### **Global Fisheries Production**

Total global fisheries production has been increasing over the past 30 years; however, the driving component of that growth has been an emerging global aquaculture sector. Global aquaculture production increased from 10.2 million metric tons (mmt) in 1984 to 59.4 mmt in 2004 (Figure 4.1). Aquaculture now represents approximately 37% of total fisheries production worldwide. However, when one restricts the definition of “production” to fish caught or produced for human consumption (that is, excluding industrial catches), aquaculture represents approximately 43% of total fisheries production. However, it is difficult to accurately estimate this percentage since a growing portion of small pelagics, such as Chilean jack mackerel, is now consumed directly by humans rather than being reduced (Zaldivar, 2004; Wray, 2001). Aquaculture has been the

fastest growing food sector over the past 20 years, with an average annual growth rate of 8.7% (Tacon, 2005; FAO, 2005). Developing countries have been and will continue to be the main drivers of this growth (Figure 4.2). Of the top five aquaculture producing countries, four of the five are developing countries (India, China, Philippines, Indonesia) and four of the five are Asian countries (China, Philippines, Japan, Indonesia).

**Figure 4.1. Global fisheries production: capture fisheries and aquaculture 1984-2004.**



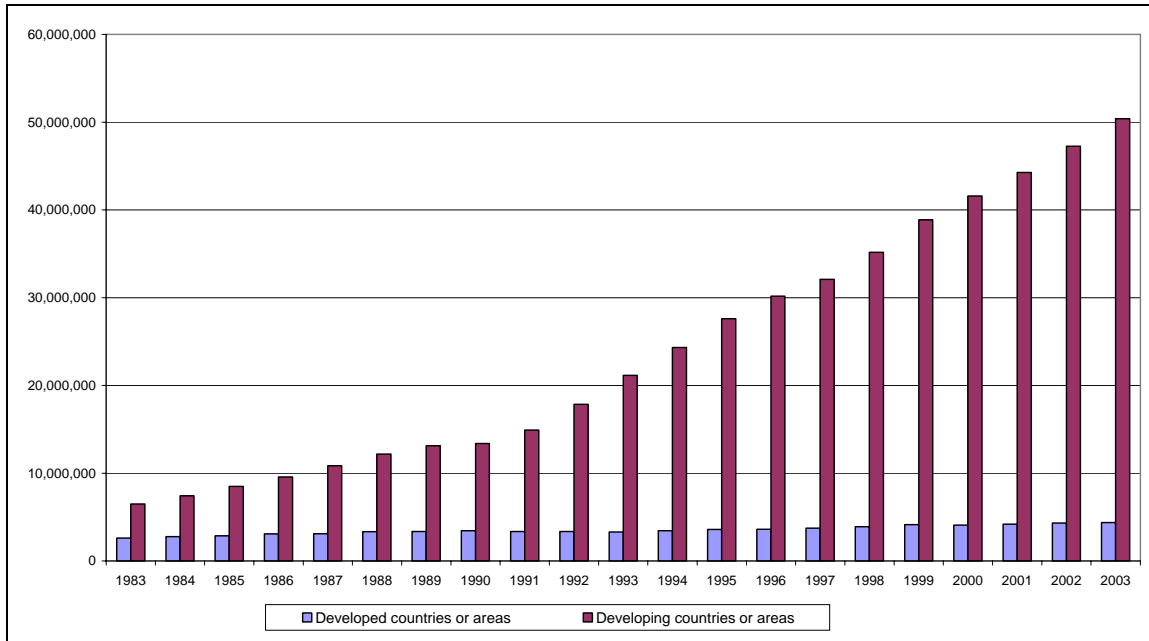
Source: FAO, 2005

### Global Fish Meal and Fish Oil Production

The major producers of fish meal are the following: Peru, Chile, China, Thailand, USA, Japan, and Scandinavia - which is an aggregation of Iceland, Norway and Denmark (Figure 4.3). According to the Fishmeal Information Network (FIN), there are approximately 400 dedicated fish meal plants that produce about 6.3 million tons of fishmeal and 1.1 million tons of oil annually from about 33 million tons of whole fish and trimmings. Dedicated fishing fleets accounted for 27.4 million tons, while trimmings and rejects from food fish accounted for the remaining 5.6 million tons (FIN, 2005a).

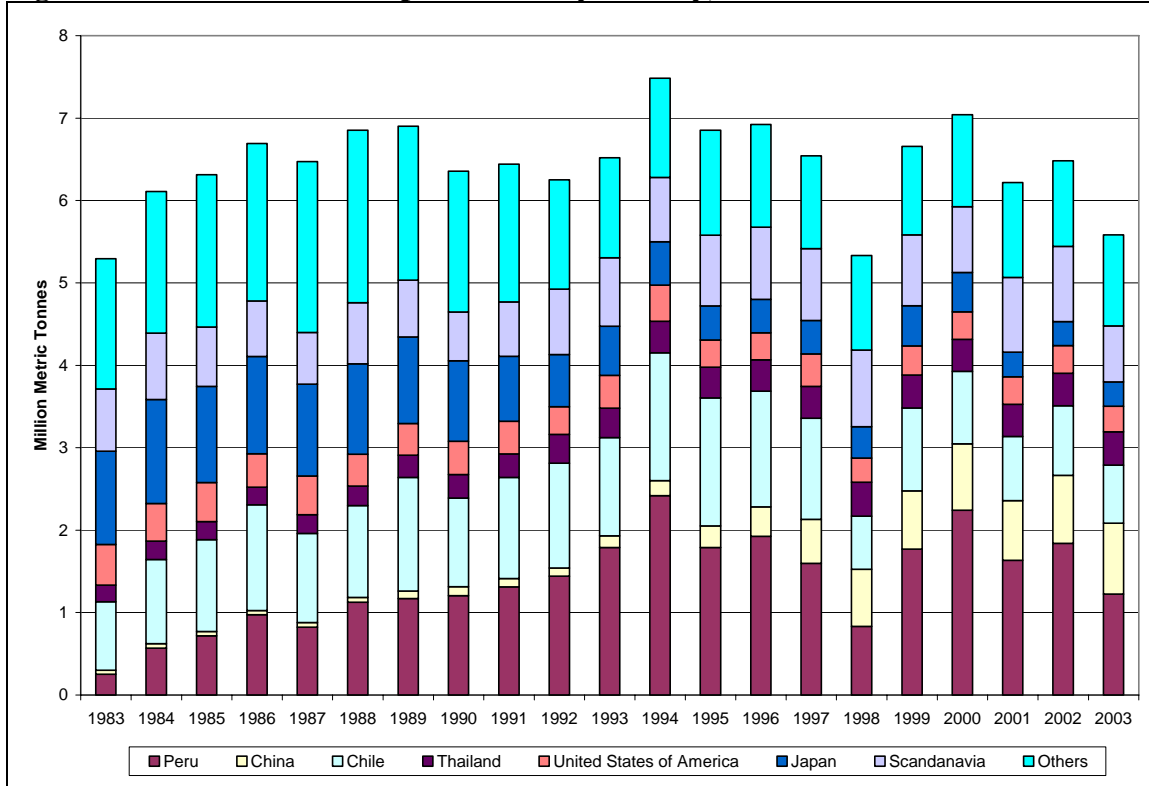


**Figure 4.2. Global aquaculture production by economic class grouping, 1983-2004.**



Source: FAO, 2007

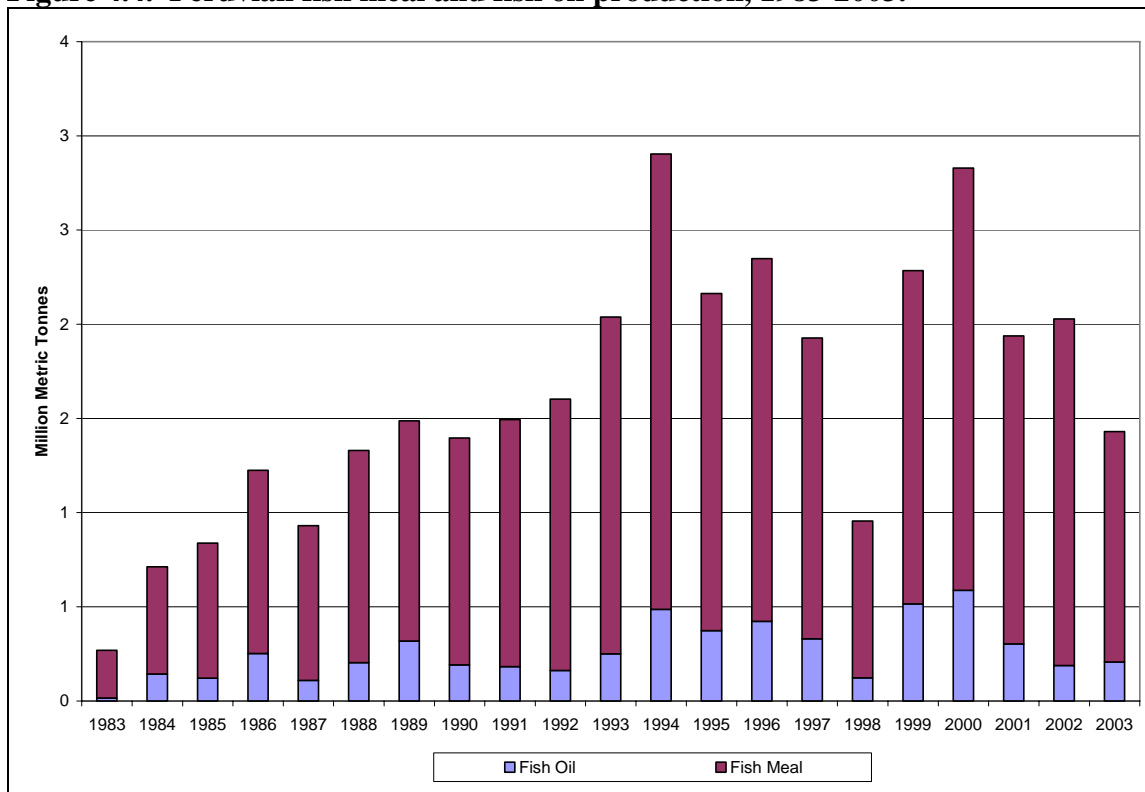
**Figure 4.3. Global fish meal production by country, 1983-2003.**



Source: FAO, 2005

Peru is the major supplier of both fish meal and fish oil worldwide, accounting for 28% of fishmeal and 29% of fish oil production in 2003 (Figures 4.3 & 4.5). Approximately 600 fishing vessels comprise the Peruvian fishery, of which 550 are wooden vessels for artisanal fishing (IFFO, 2005b). In Peru, the major species harvested are anchovy (*Engraulis ringens*) and jack mackerel (*Trachurus symmetricus*) (FIN, 2005b). Both species are small in size, have a short life span, and are highly fecund. Since they are both highly influenced by El Niño, their harvest levels can fluctuate significantly during El Niño events (Figure 4.4). The most recent El Niño event (1997-1998) was the strongest on record. It developed more quickly than any other El Niño event in the past 40 years and it had an immediate impact on weather, marine ecosystems, and fisheries (McPhaden and Soreide, undated).

**Figure 4.4. Peruvian fish meal and fish oil production, 1983-2003.**



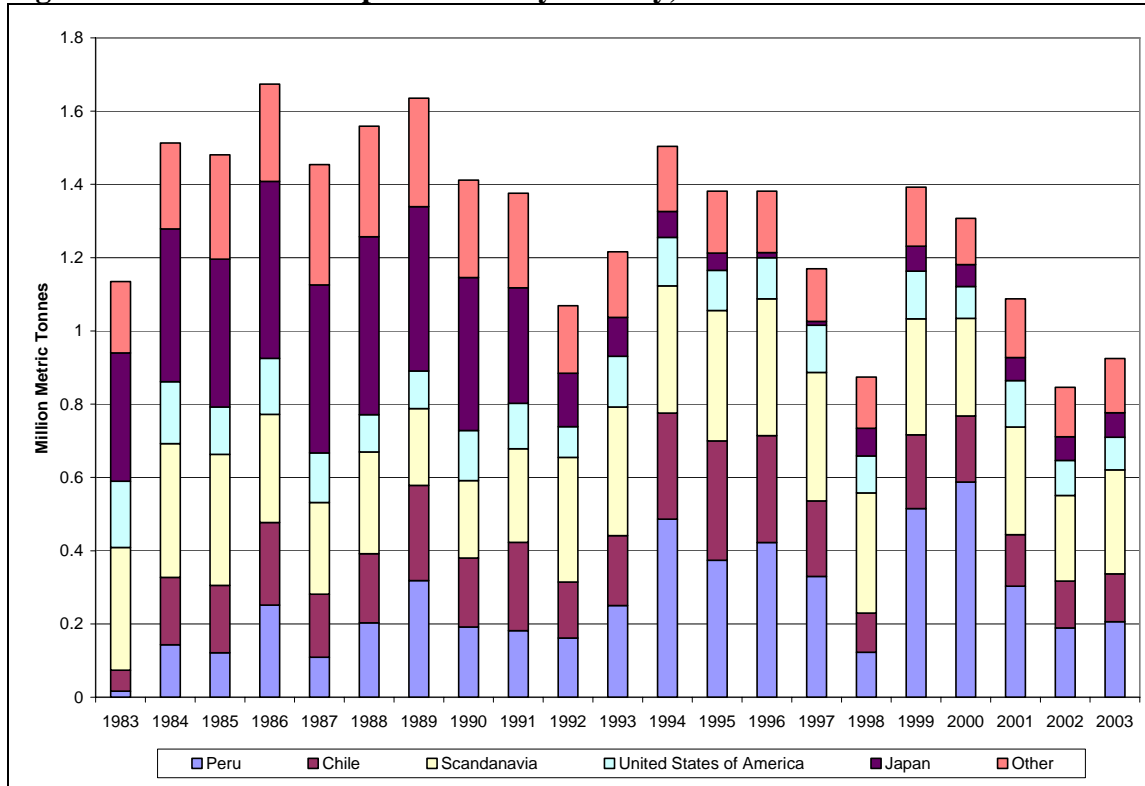
Source: FAO, 2005

Scandinavia and Peru dominate the global production of fish oil. The majority of fish oil produced is devoted to the production of aquafeeds (81%), while the remainder is allocated across the industrial (5%) and edible foods (14%) sectors (Figure 4.7). The major producers of fish oil are: Peru, Chile, Japan, Scandinavia, and the United States (Figure 4.5).

Most of the major producers of fish meal are also the major producers of fish oil, given the nature of fish meal and fish oil production. In general terms, fish meal is produced through a process of cooking, pressing, drying, and milling. The production process is comprised of six main steps. The first step is to inspect the raw fish for freshness and expected yield of meal and oil. Once the raw fish are cleaned for production, they are conveyed through a steam-heated, continuous cooker at temperatures ranging from 70°C to 100°C. The high temperature helps

sterilize the fish as well as separate out proteins and oils. This cooked material is then fed through a screw press, where the majority of the remaining liquids are pressed out of the material. The collected liquid and oils are further refined through decanting processes, while the remaining presscake material is dried and milled to form a product ready for export.

**Figure 4.5. Global fish oil production by country, 1983-2003.**



Source: FAO, 2005

Fish meal can be categorized into the following product headings (FIN, 2005c):

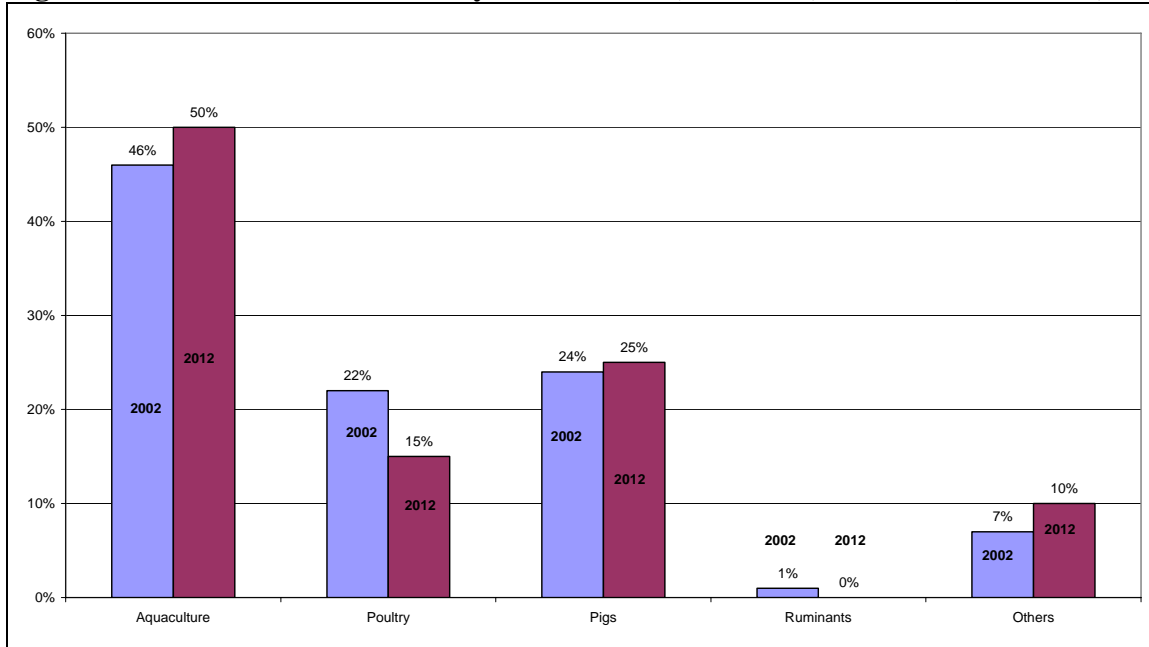
- High quality – usually for small-scale aquaculture units (trout farms) or marine species
- Low temperature meal – highly digestible and used in salmon and piglet production
- Prime – specified protein content exceeding 66 percent but not exceeding 68 percent
- Fair average quality (FAQ) – lower protein content feed ingredient for pigs and poultry

### Uses of Fish Meal and Fish Oil

Pike (2005) estimated that 6.2 million tons of fish meal and 0.975 million tons of fish oil were produced globally in 2002. Based upon those estimates of total global production, Pike calculated that the aquaculture sector consumed 46% of the fish meal and 81% of the fish oil produced in 2002 (Pike, 2005). By 2012, Pike estimates that the percentage of fish meal consumed by the aquaculture sector will be 50% and the percentage of fish oil comprising aquafeeds will be 88%. These estimates are based on a forecast of global fish meal (6.0 million tons) and fish oil (1.1 million tons) production in 2012 (Pike, 2005). Historically, global fish meal and fish oil production has averaged 6 mmt and 1.2 mmt, respectively, and this level of

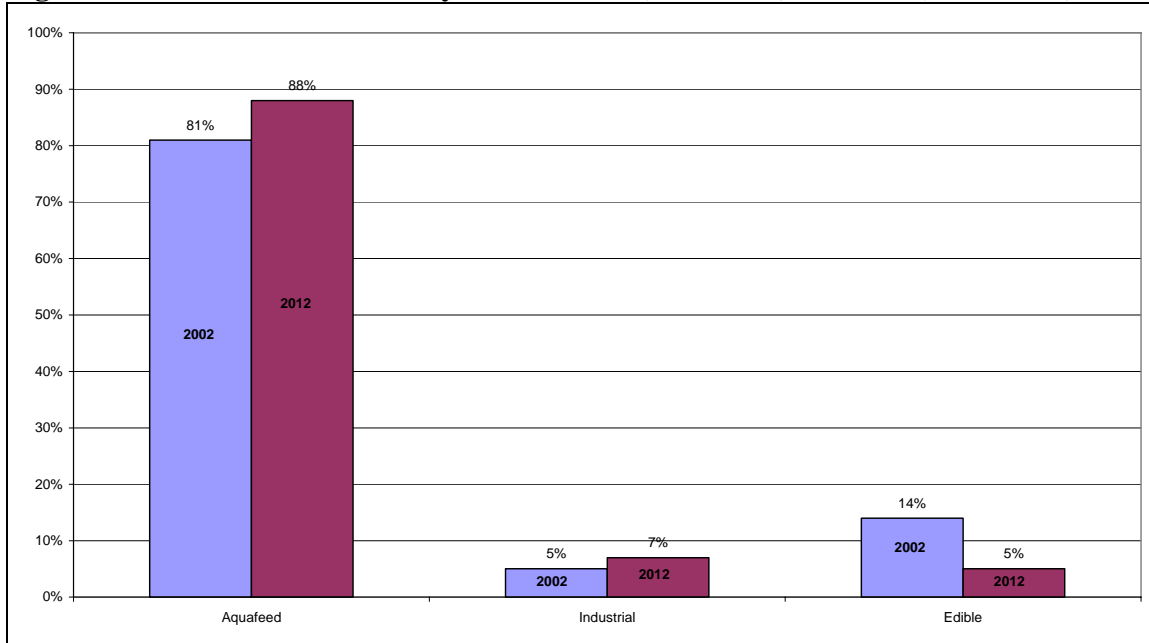
production is expected to continue in the future. Figures 4.6 and 4.7 illustrate the allocation of fish meal and fish oil across the various animal producing sectors.

**Figure 4.6. Fish meal utilization by sector: 2002 (estimated) vs. 2012 (forecasted).**



Source: Pike, 2005

**Figure 4.7. Fish oil utilization by sector: 2002 (estimated) vs. 2012 (forecasted).**

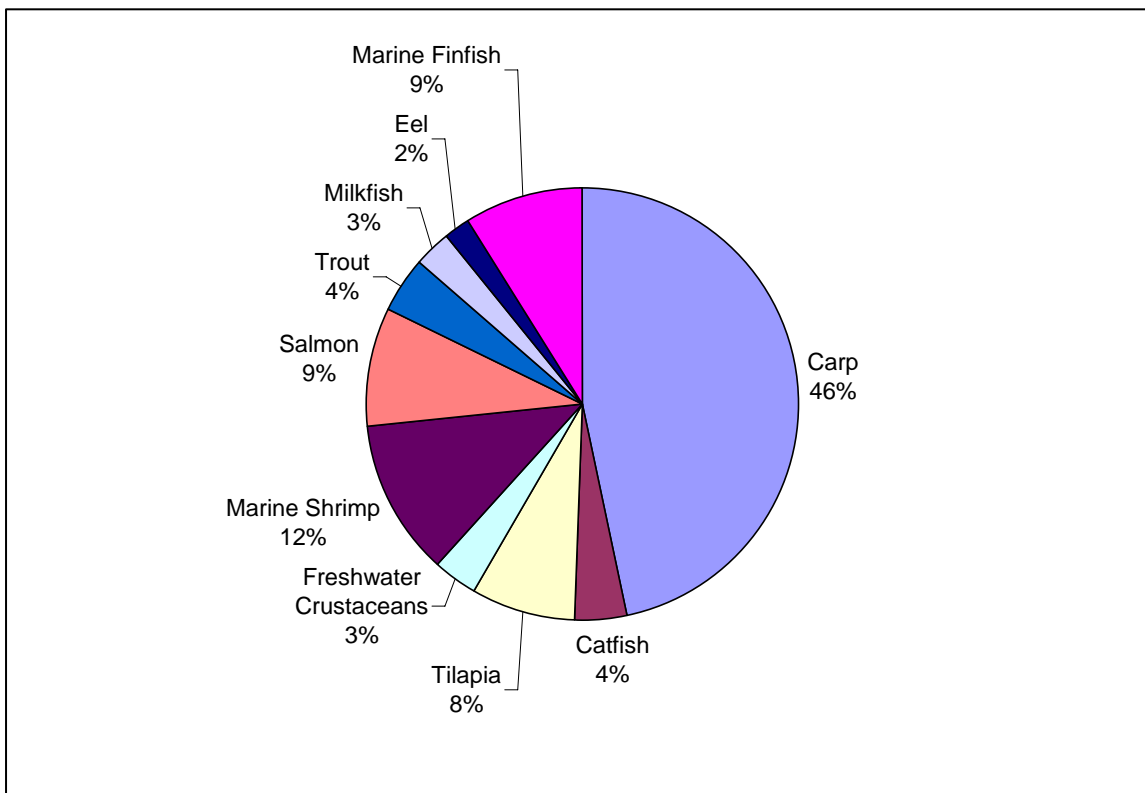


Source: Pike, 2005

Within the aquaculture sector, the major species groups dependent upon the use of compound aquafeeds in 2002 included (Tacon, 2004):

- carp (8.27 mmt, or 46.6% of aquafeeds used in 2002)
- marine shrimp (2.08 mmt)
- salmon (1.58 mmt)
- marine finfish (excludes mullets; 1.56 mmt)
- tilapia (1.35 mmt)
- trout (0.74 mmt)
- catfish (0.72 mmt)
- freshwater crustaceans (0.61 mmt)
- milkfish (0.47 mmt), and
- eels (0.38 mmt)

**Figure 4.8. Total estimated compound aquafeed production, 2002.**



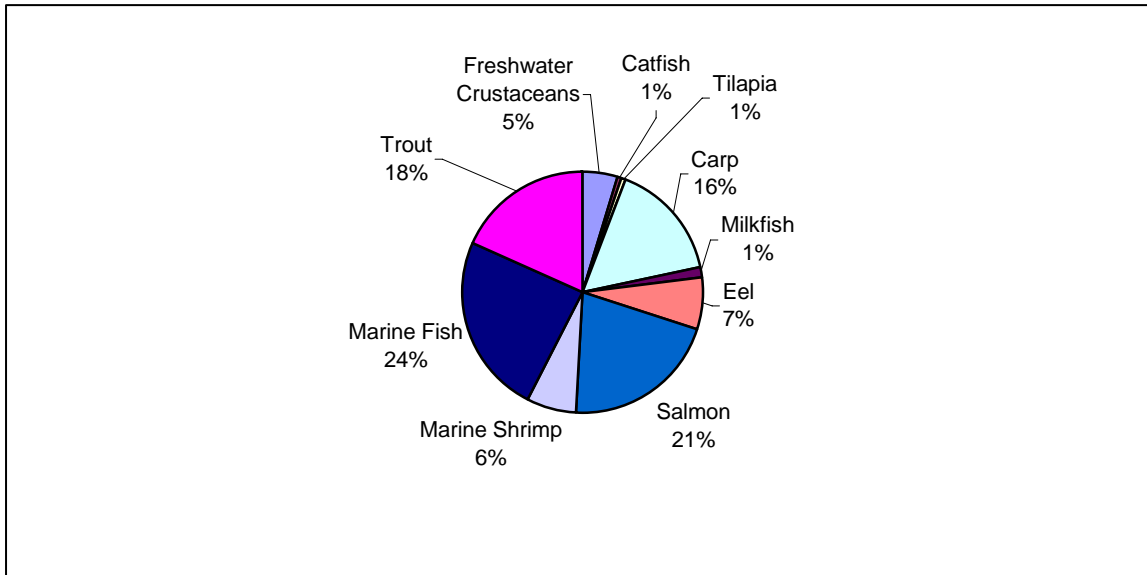
Source: Tacon, 2004

As mentioned earlier, China is the global leader in aquaculture production and one of the major species cultured by the Chinese is carp. Most carp are omnivores that can be raised in either extensive, semi-intensive, or intensive aquaculture production systems. The more intensive production systems involve augmenting the diet of the carp with fish meal to increase their rate of growth and meat production. While the quantity of aquafeed consumed per carp may be small, the total amount of aquafeed consumed by the sector is quite large, given the quantity of carp produced annually. To put global carp production into perspective, the Cyprinidae (carp)

family accounted for 31% of total aquaculture production, greater than both Penaeidae (shrimp) and Salmonidae (salmon) production combined, in 2003 (FAO, 2005).

Currently, China is the largest importer of fish meal, importing more than 1 million tons per year, followed by Japan (approximately 400,000 tons), Taiwan (approximately 250,000 tons) and Germany (approximately 200,000 tons) (IFFO, 2005b). Through their demand for fish meal and fish oil, China will ultimately have an impact on global fish meal and fish oil prices. In general, aquaculture's dependence upon fish meal and fish oil is greatest for those which are highly valued species, including all carnivorous (i.e., fish/invertebrate animal-eating) finfish species and most omnivores/scavenging crustacean species (Tacon, 2004; Zaldivar, 2004).

**Figure 4.9. Estimated global use of fish meal within compound aquafeeds in 2002 by major cultivated species (Values expressed as % of total fish meal used within aquafeeds, dry as-fed basis).**

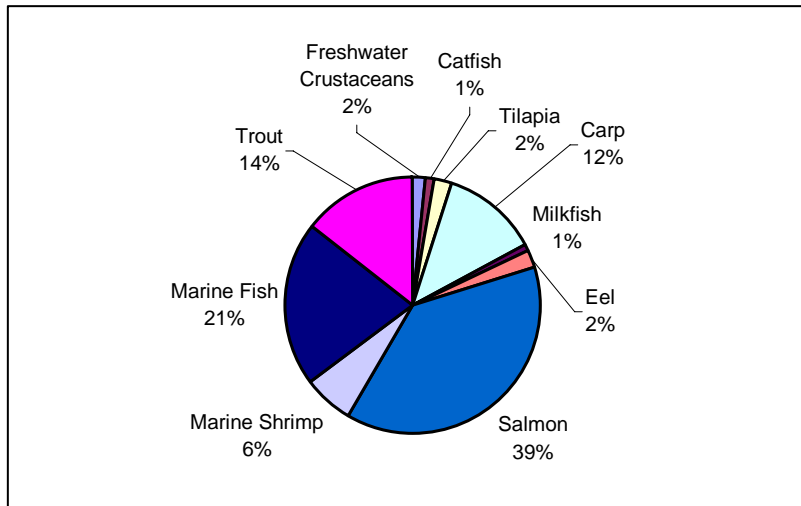


Source: Tacon, 2004

### Future Trends in Fish Meal and Fish Oil Consumption

By 2012, the consumption of fish meal and fish oil by the aquaculture sector is expected to increase (Figures 4.6 & 4.7). In general, lower costs of production and increasing levels of production have led to falling market prices for aquaculture species. Since feed costs represent 40-70% of total production costs, depending on the species, producers are sensitive to rising fish meal and fish oil prices (Tacon, 2005; Anderson, 2003; Guttormsen, 2002). The challenge is to identify lower cost substitutes for fish meal and fish oil while still maintaining both the quality and quantity of production achieved through the use of fish meal and fish oil.

**Figure 4.10. Estimated global use of fish oil within compound aquafeeds in 2002 by major cultivated species (Values expressed as % total fish meal used within aquafeeds, dry as-fed basis).**



Source: Tacon, 2004

*Note:* It is important to note that actual fish meal and fish oil consumption is higher than is represented in Figures 4.9 and 4.10, due to the omission of 10% of total finfish and crustacean production in the calculations by Tacon (2004).

The inclusion of fish meal and fish oil in the diets of animals is not an arbitrary decision on the part of producers and feed manufacturers. Fish meal is an excellent source of high quality proteins and long chain omega-3 fatty acids, including EPA (eicosapentaenoic acid) and DHA (docosahexaenoic acid). Both DHA and EPA provide essential health benefits, including cardiovascular health, improved cellular function, and overall brain and nervous system function. Fish meal also provides essential amino acids in a highly digestible form. Across all animals, fish meal use has led to increases in growth rates, improvements in feed conversion ratios, lower allergic reactions, and improvements in disease resistance (IFFO, 2005a). The consumption of omega-3 fatty acids is also beneficial to humans, especially with regard to cardiovascular health (Seierstad et al., 2005; Kris-Etherton et al., 2002; Eliseo et al., 2002; Connor, 2000; Kromhout et al., 1985).

For certain aquaculture species, fish meal and fish oil may become limiting factors of production, since they cannot be perfectly substituted with other protein sources to date. At low levels of fish meal and fish oil inclusion, issues regarding digestibility, growth rates, disease resistance, and overall quality of meat can emerge. Fish meal cannot easily be substituted in the diets of pigs (Makkink et al., 1994; Jorgensen et al., 1984; Woodman and Evans, 1951) and poultry (Klasing, 1998; Pike et al., 1984; Pensack et al., 1949). In fact, the use of fish meal by the pig sector is expected to remain essentially unchanged from 2002 to 2012 (Figure 4.6). Thus, the issue of reduced substitutability across different protein sources is not unique to the aquaculture sector.

According to Tacon (2005), some typical dietary fish meal inclusion levels within conventional livestock feeds are:

- Pig: Creep 5-10%, Weaner 5-10%, Grower 3-5%, Finisher 3%, Sow 3%
- Poultry: Chick rearing, up to 3%, Broiler 2-5%, Breeder 1-5%, Layer 2%, Turkey 3-10%, Pheasant/game 3-7%
- Dairy Cattle: Late Pregnancy 2.5-10%, Lactating 5-10%, Calves 2.5-10%
- Sheep: Breeding ewes/pregnant 2-7.5%, Lactating 5-10%, Growing Lambs 2.5-10%
- Carnivorous Fish (Salmonids/Eels/Marine Finfish): Starter 35-75%, Grower 20-50%
- Omnivorous Fish (Carp/Tilapia/Catfish): Starter 10-25%, Grower 2-15%
- Marine Shrimp: Starter 25-50%, Grower 15-35%

Research and development of new protein sources is ongoing by all users of fish meal and fish oil, not just the aquaculture sector. Higher fish meal and fish oil prices have and will continue to provide the economic incentives to develop more efficient production systems, to improve diet formulations, and to innovate and discover new compounds that can provide high-quality substitutes for fish meal and fish oil.

### **Soybean Meal and Oil and Other Substitute Feeds**

Possible land-based substitutes in the oil meal family include: rapeseed, soybean, corn gluten, wheat, gluten, and terrestrial byproduct meals that include meat meal, bone meal, feather meal and blood meal (Tacon, 2004). Marine-based substitutes include the use of small marine crustaceans, including krill, copepods, and algae. Other potential sources of fish meal include the recycling of bycatch for use in production, as well as the use of fish processing byproducts, mainly the excess trimmings and wastes that result from processing fish for human consumption. In addition, bio-technological substitutes are in the early stages of development.

The main impediment in substituting vegetable-based proteins for marine-based proteins concerns the underlying differences in protein quality. Plant-based replacements can be substituted up to a point before growth, immunity, and overall fish health and quality decline.

Another important issue is the impact of protein substitutes on human health and nutrition. A recent study by Norwegian researchers investigated the effect of dietary intake of Atlantic salmon on cardiac patients. Atlantic salmon were separated into three groups and fed a diet ranging from high (100% fish oil) to low (100% rapeseed oil) levels of omega-3 fatty acids. Cardiac patients were separated into three groups and consumed the differently-fed Atlantic salmon over a six-week period. All human subjects had statistically significant changes in their serum fatty acid profiles, regardless of the differences in feed across the salmon groups; however, the changes were even more pronounced for those whose feeds contained the greatest fish oil content (Seierstad et al., 2005).

In addition to reiterating the cardiovascular benefits of diets high in omega-3 fatty acids, this study also highlights the importance of the composition of aquaculture feeds in human nutrition. Diets high in plant oils can have nutritional implications, not only for animal but also human health and nutrition. Regardless, soybean meal still remains the main competitor to fish meal within the global, animal meal sector.



## The Relationship between Fish Meal and Soybean Meal

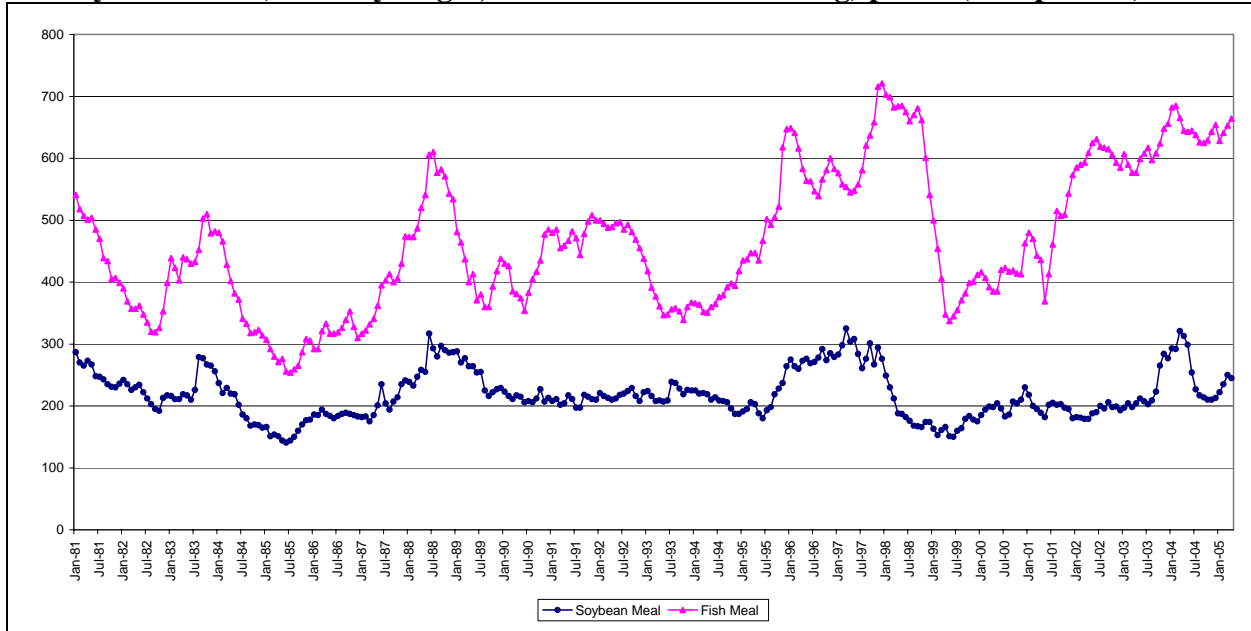
Soybean meal is a vegetable-based protein source that provides amino acids and essential nutrients, although not of the same caliber as fish meal. Historically, fish meal has commanded a higher price than soybean meal (Figure 4.11). The price differential between the two protein sources is related to differences in quality. Using price data from the 1980s and 1990s, if one were to account for the differences in protein content across both meals, the price gap essentially disappears (Asche and Tveteras, 2000). The critical question to ask is: Does fish meal have unique nutritional properties that distinguish it from the general oilseed market? If fish meal is a substitute for other protein sources on the market, then substitution across protein sources should occur. The ability to make substitutions will reduce the possibility of large increases in the price of fish meal and fish oil as the demand for fish meal and fish oil increases.

However, if it is the case that fish meal is a unique protein with limited substitution possibilities across other protein sources, this has implications for future pricing of fish meal and fish oil. A study by Asche and Tveteras (2000) examined the relationship between aquaculture and reduction fisheries. The authors analyzed the monthly prices for soymeal and fish meal from the United States and Europe from January 1981 to April 1999. Through co-integration analysis, the authors found evidence that fish meal and soymeal are strong substitutes and that fish meal is part of the larger oil meal market (Asche and Tveteras, 2000). Their work is consistent with research by Vukina and Anderson (1993), which examined the soy meal/fish meal market from 1986-1991. Vukina and Anderson found the high degree of substitutability between soy meal and fish meal such that cross-commodity futures hedging could successfully reduce price risk in the fish meal market.

While the work of Vukina and Anderson (1993) and Asche and Tveteras (2000) confirmed a co-integrated relationship between soybean meal and fish meal throughout the 1980s and 1990s, recent research by Kristofersson and Anderson (2005) suggests that this historical relationship has changed, following a structural break in 1998. Kristofersson and Anderson identified two structural breaks, one in October 1996 and one in October 1998, with the latter occurring after the El Niño event in 1998. Their findings suggest that fish meal and fish oil post-1998 are not behaving as close substitutes in the more general oil meal market as was the case in the past. This has potential implications for the future of not only the aquaculture sector, but also reduction fisheries.

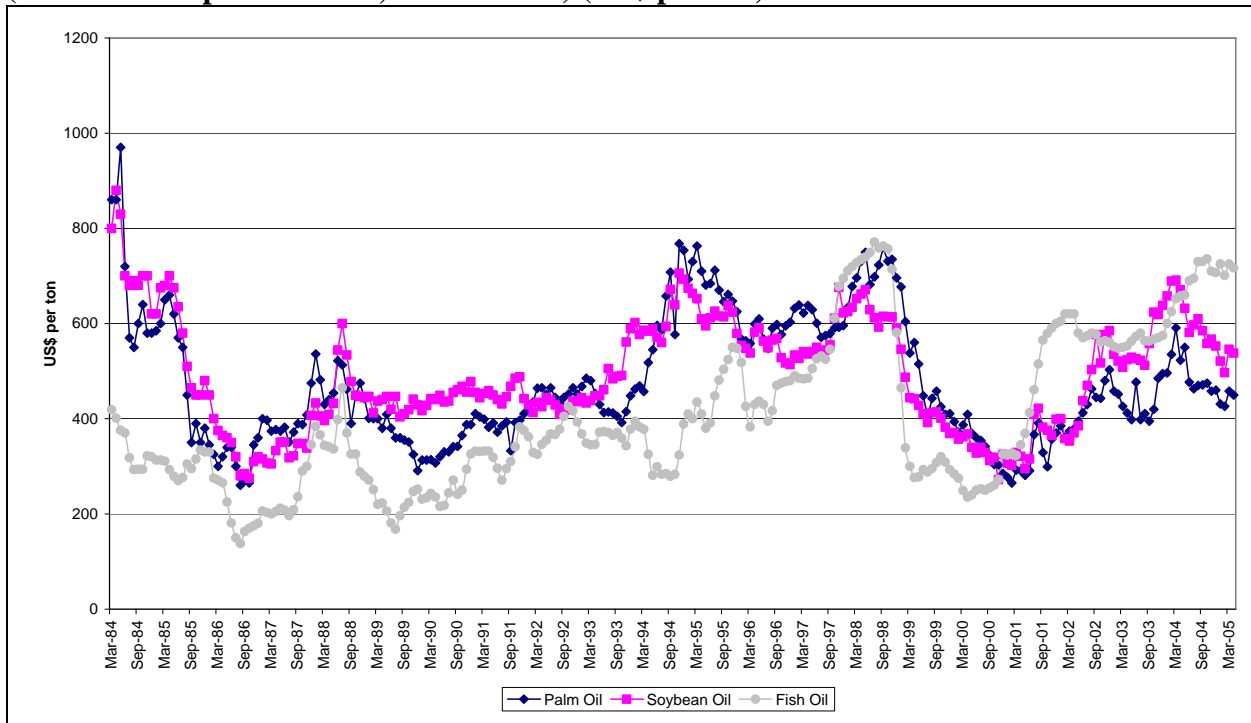
An indication of the changes that are occurring with regard to the relationship between fish meal and the aquaculture industry can be seen in Figure 4.13. This figure presents an index of predicted fish meal use in aquaculture under the assumption of no substitutability with the input/output relationship reported by Naylor et al. (2000). If no substitution with other protein sources is possible, predicted fish meal use (solid line) should be identical to actual fish meal use (dashed line).

**Figure 4.11. Monthly averages for fish meal (64/65% any origin, wholesale CIF Hamburg) and soybean meal (44% any origin, CIF Rotterdam/Hamburg) prices (US\$ per ton).**



Source: FAO Globefish Commodity Report, February 2005

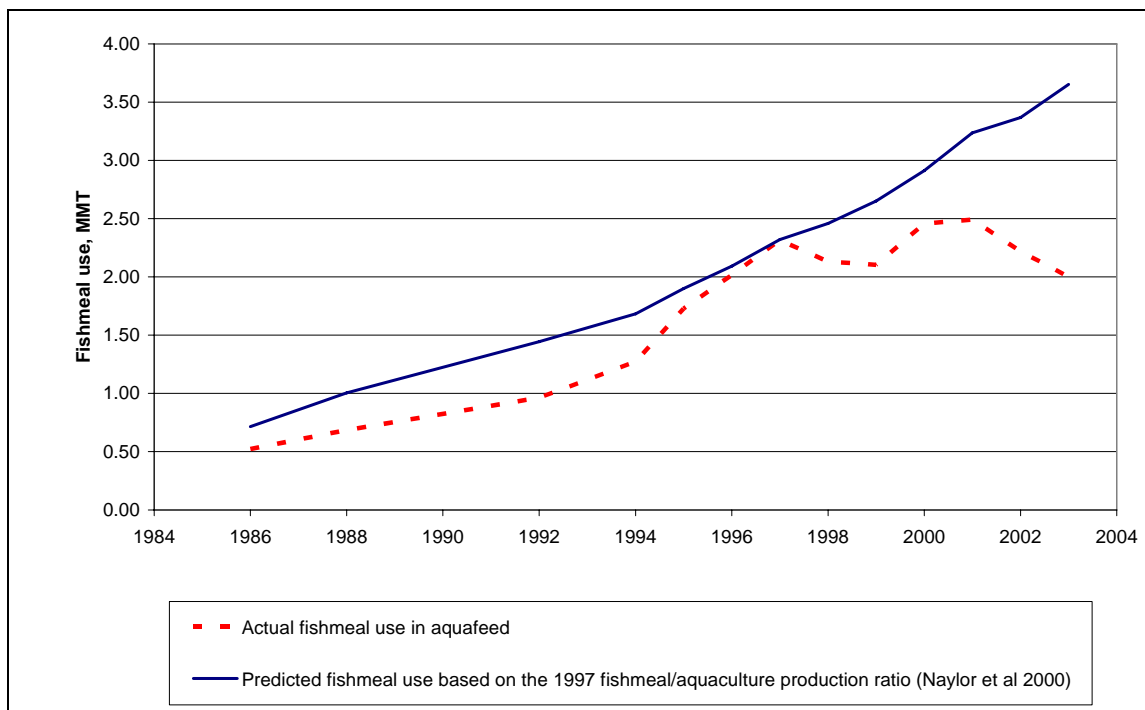
**Figure 4.12. Fish oil (international prices, any origin CIF N.W. Europe), palm oil (international palm oil prices-RBD palm olein, Malaysia, CIF Rotterdam), and soybean oil (international prices-Dutch, FOB ex-mill) (US\$ per ton).**



Source: FAO Globefish Commodity Report, February 2005

While the trends of the actual and predicted fish meal use were similar prior to 1997, it appears that, post-1997, this relationship has broken down. The actual use of fish meal has fluctuated between 2.0 and 2.5 million metric tons, suggesting that the aquaculture industry has been able to either find substitutes for fish meal and/or they have improved farm management and/or the formulation of the diet as to improve the efficiency of the production process. Since 1997, the aquaculture industry has been able to sustain an annual average rate of growth of 7.9% per year while consuming essentially the same quantity of fish meal over that same period. Additionally, there has been little change in the output mix of aquacultured species as the share of carnivorous species produced has fluctuated between 20% and 25% over that same time period (Kristofersson and Anderson, 2006).

**Figure 4.13. Estimated actual versus predicted use of fish meal in aquaculture.**



Source: Kristofersson and Anderson (2005)

Looking at the farmed salmon industry, the percentage of dietary fish meal and fish oil used within salmon feeds has changed dramatically over the past two decades (Table 4.1). There has been a decrease in dietary protein levels within salmon feeds, with an equivalent increase in dietary lipid and energy levels (Tacon, 2005). This shift has resulted in faster fish growth rates and improved feed efficiencies. Today, Chilean salmon production cycles are at least 20-25% shorter than they were ten years ago, due to the use of higher energy and lower protein feeds (Larrain et al., 2005). Canadian and Norwegian producers currently lead the way in terms of the current level of dietary marine protein (i.e., fish meal) and marine lipid (i.e., fish oil) substitution rates at 55% and 50%, followed by Chile at 60% and 20%, and the UK at 45% and 10%, with no apparent loss in fish growth or nutritional quality of the fish carcass (Tacon, 2005).

**Table 4.1. Inclusion of fish meal within salmon feeds, 1985-2005.**

<b>Year</b>	<b>Fishmeal Inclusion</b>	<b>Dietary Lipid Levels</b>
<b>1985</b>	<b>60%</b>	<b>10%</b>
<b>1990</b>	<b>50%</b>	<b>15%</b>
<b>1995</b>	<b>45%</b>	<b>25%</b>
<b>2000</b>	<b>40%</b>	<b>30%</b>
<b>2005</b>	<b>35%</b>	<b>35-40%</b>

Source: Tacon, 2005

Further research and development in nutrition and husbandry will help improve feed conversion ratios within the aquaculture sector. Already, within salmon production the economic feed conversion ratio has fallen significantly from over 2 to 1.3 during the past 20 years (Table 4.2).

**Table 4.2. Economic FCR for farmed salmon, 1983-2003.**

<b>Year</b>	<b>Economic FCR</b>
<b>1983-1985</b>	<b>&gt; 2.0</b>
<b>1986-1990</b>	<b>1.7</b>
<b>1991-1995</b>	<b>1.6</b>
<b>1996-2000</b>	<b>1.5</b>
<b>2001-2003</b>	<b>1.4</b>
<b>Current 2003</b>	<b>1.3 (range 1-1.5)</b>

Source: Tacon, 2005

The economic feed conversion ratio is defined as (Economic FCR = Total feed fed / total live fish produced), which takes into account all fish mortality over the production cycle. It is interesting to note that the economic FCR for farmed salmon (including large rainbow trout) is the lowest of all the major, cultured/fed aquaculture species, ranging from a high of 2.4 (freshwater crustaceans), 2.0 (feeding carp, tilapia, milkfish, marine finfish, eel), 1.9 (marine shrimp), 1.6 (catfish) to a low of 1.3 (trout and salmon) (Tacon, 2004). These gains in efficiency can be attributed to better feed manufacture and formulation and better farm management (Tacon, 2005). Such technological advancements will help check prices until a biological limit on vegetable protein inclusion is reached.

### **The Role of Fisheries Management**

As mentioned before, if fish meal and fish oil have unique properties and few substitutes, as demand increases, so too will prices. Without adequate management of the resource, price increases could lead to an increase in the amount of effort exerted in reduction fisheries. Such a situation could lead to a reduction in stock biomass and the potential collapse of reduction fisheries. If mismanagement of the resource occurs and effort is allowed to increase in response to price increases, harvest levels could ultimately decrease due to over-harvesting. In contrast, within well-managed fisheries, harvest levels would remain stable in accordance with established harvest targets and effort controls, which would help to ensure the sustainable use of the resource. Within well-managed fisheries, local fishermen and local economies would benefit from increased prices for their harvest.

Currently, the reduction fisheries in Peru and Chile are managed under harvest quota systems designed to foster the sustainable use of this resource. In Peru, the government's Institute of Fisheries Research (IMARPE) provides assistance in determining current stock assessments and the appropriate quota for a given season. In Peru, global satellite tracking systems are installed on all fishing boats that operate outside the 5-mile limit, allowing the government to strictly monitor all vessels to ensure compliance with geographical, temporal, or seasonal regulations (FIN, 2005b; Pike and Barlow, 2002). In addition, the Peruvian government imposes season limits, area closures, and limited entry to new fishing boats within their exclusive economic zone. Fishing is halted during February and March to reduce pressure on juvenile anchovy and sardine stocks, and the fishery closes from August to October to protect spawning stocks (FIN, 2005b).

In Chile, similar fishing bans are imposed to protect juvenile stocks and critical spawning seasons for anchovy and sardines. Total allowable catch (TAC) limits are set for each species declared in full exploitation and the Institute of Fisheries Research, a Chilean government agency, provides guidance on establishing the quota in that country's reduction fisheries (FIN, 2005a or b or c). Well-established and enforced fisheries management are critical to the sustainability of reduction fisheries, and countries like Peru and Chile recognize the importance of protecting their nation's natural resources and ensuring the sustainable use of the resource for current and future generations.

With regard to U.S. reduction fisheries, the predominant species targeted are menhaden, herring and sardines. The U.S. Atlantic menhaden (*Brevoortia tyrannus*) fishery is one of the most productive and important fisheries on the Atlantic coast (ASMFC, 2007). This fishery is managed under a Fishery Management Plan by the Atlantic States Marine Fisheries Commission (ASMFC). In 2001, the ASMFC approved Amendment 1 to the Interstate Fishery Management Plan for Atlantic menhaden. The objective of the amendment was to manage the Atlantic menhaden fishery according to fishing mortality and spawning stock biomass targets. In October of 2006, a cap on annual reduction fishery harvests was implemented under Addendum III. The cap, which sets the level of Atlantic menhaden harvests for reduction purposes at 109,020 metric tons is in effect until 2010. The Gulf of Mexico menhaden (*Brevoortia patronus*) fishery is one of the largest fisheries, by volume, in the United States. It is managed under a regional Menhaden Fishery Management Plan by the Gulf States Marine Fisheries Commission (GSMFC). This fishery is also one of the most effort-controlled, with only 41 vessels currently operating in the Gulf region (GSMFC, 2007). The Atlantic herring (*Clupea harengus*) fishery is similarly managed under a Fishery Management Plan by the New England Fisheries Management Council (NEFMC). According to the NEFMC website, herring is managed by the NEFMC through the use of a quota system. When 95% of the annual quota is caught within one of the herring management areas, that area is closed to fishing until the start of the next fishing year (NEFMC, 2007). On the West Coast, the Pacific Fishery Management Council's Coastal pelagic species (CPS) Fishery Management Plan manages species including Northern anchovy (*Engraulis mordax*), Pacific sardine (*Sardinops sagax*), Pacific (chub) mackerel (*Scomber japonicus*), Jack mackerel (*Trachurus symmetricus*) and Market squid (*Loligo opalescens*).

## **Factors that will Influence the Future of the Fish Meal and Fish Oil Industry**

### *Continued Demand from Terrestrially-based Animal Protein Sectors*

It is important to recall that the poultry and pig sectors currently consume the same percentage of fish meal (46% combined) as the aquaculture sector (46%) (Figure 4.6). Both poultry and pig production are forecasted to expand as global demand increases. Aquaculture will continue to face competition for fish meal and fish oil resources from these two sectors. The poultry and pig sectors currently rely on fish meal and, to a lesser extent, fish oil in their feed formulations due to their high quality and current low cost, relative to other protein sources. While these sectors respond to price incentives when determining the composition of their animal feeds, at some stages of production the ability to substitute fish meal and fish oil is limited. This situation is similar to the situation faced by aquaculture producers, who also must contend with limited substitution possibilities at certain stages of production.

The production of all animal proteins is influenced by the price and availability of fish meal and fish oil. This has potentially serious implications for the availability of animal proteins raised for human consumption. As the price of fish meal and fish oil rises relative to other protein sources, such as soybean meal, both agriculture and aquaculture users will attempt to substitute across protein sources to reduce production costs while maintaining nutritional and quality standards for their products. Following the El Niño event in 1998, this sort of price-driven substitution was observed in the poultry and pig sectors, as the price of both fish meal and fish oil rose (Figures 4.11 & 4.12). The poultry sector halved its annual demand for fish meal from 2.4 mmt to 1.2 mmt, while the pork sector reduced its demand by 20% (Jystad, 2001). Still, there is a point at which both the agriculture and aquaculture sectors will face limitations regarding their ability to substitute fish meal and fish oil within their production cycles.

### *Continued Growth in the Global Aquaculture Industry*

Steady and rising growth in the aquaculture sector is forecasted to continue into the future (Anderson, 2003). This growth will, in turn, fuel increased demand for fish meal and fish oil. Within the next 10 to 20 years, the global aquaculture sector is forecasted to surpass wild production, with estimates ranging between the years 2015 to 2030. (Tacon, 2004; FAO, 2000). A majority of the growth in aquaculture will come from developing countries, and in particular, Asian countries. A significant portion of the demand for fish meal and fish oil will come from China, who is already producing and importing a significant quantity of fish meal and fish oil to sustain its fisheries production. There is no sign of the Chinese fisheries industry, or for that matter its economy, slowing down in the near future.

### *Transition of Small Pelagics from Industrial Production to Human Consumption*

Within reduction fisheries, the potential exists for a shift in the final destination of fish caught in industrial fisheries. Currently, portions of fish such as anchovy, sardines, and menhaden are directly used for human consumption, thereby reducing the available supply of fish available for fish meal and fish oil production (Zaldivar, 2004; Wray, 2001). This has implications for the future supplies of fish available for reduction.

### Developments in the Markets for Protein Substitutes

Developments in the availability and efficacy of protein substitutes will have an impact on the price of fish meal and fish oil. Increases in the price of fish meal and fish oil are important stimuli in the development of protein alternatives. As prices rise, the return from investing in alternative protein sources increases. Technologies that were not feasible at lower fish meal prices are now economical, given higher prices. Thus, higher fish meal and fish oil prices will provide the economic incentives for conservation and the development of new substitutes.

### Environmental Conditions

Future environmental shocks, such as El Niño events, will affect the future price of fish meal and fish oil. In 1998, El Niño was responsible for a significant decrease in Peruvian harvests, which in turn caused fish meal and fish oil prices to rise to all-time highs (Figures 4.11 & 4.12). At that time, the poultry and pig sectors responded by substituting away from the higher-priced protein source. Another significant El Niño event could further disrupt fish meal and fish oil production and prices. Over the long term, another factor—climate change and subsequent sea temperature rise—may contribute to a change in the location and productivity of reduction fisheries. The ecological and economic effects that such a change could have are currently unknown and subject to great debate. Nonetheless, it could prove to be an important factor affecting the future supply of fish from reduction fisheries.

### Effective Management of Reduction Fisheries

Countries whose economies rely upon reduction fisheries have acknowledged the importance of effective fisheries management in sustaining their respective industries. As the world's major suppliers of both fish meal and fish oil, both Peru and Chile have implemented fishing regulations to protect their valuable reduction fisheries. To date, fish meal production has averaged 6.4 mmt over the past 20 years, despite increases in production across all animal protein sectors (FAO, 2005). Effective management of reduction fisheries will remain an essential factor in ensuring the sustainability of this resource.

### Refinements in Husbandry Techniques

As mentioned above, the percentage of dietary fish meal and fish oil used within feeds and, in particular, salmon feeds changed dramatically over the past two decades. This development, coupled with improved farm management and better feed formulations, has led to faster growth rates and improved feed efficiencies. Further research and development in nutrition and husbandry will help improve feed conversion ratios within the aquaculture sector.

### Food Safety and Health Issues

In European markets, Bovine Spongiform Encephalopathy (BSE), also known as mad cow disease, has played an important role in shifting markets for fish meal consumption. Due to concerns in the European Union (EU) over the transmission of BSE, strict rules regarding the feed for ruminants were enacted (OJEC, 2001). These rules also prohibit fish meal consumption by ruminants based upon fears that fish meal may be contaminated with other meals that could spread BSE. In 2005, there was an amendment to the Council Decision; however, the ban on fish meal in ruminant diets was upheld pending further investigation (OJEC, 2005). The prohibition of fish meal in EU markets has led to a shift to Asian markets, where demand for fish

meal primarily used in aquaculture is strong. Thus, through regulations in other markets, more fish meal has been made available for use in aquaculture and other industries.

Another health-related issue that may impact the future availability of fish meal concerns the presence of polychlorinated biphenyls (PCBs) in aquacultured products. Fish meals have been identified as a potential source of PCBs in the meat of farmed products (FIN, 2005d; EU, 2001). Future regulations may address this problem by requiring fish meal producers to certify their product, to reduce the potential for the transmission of PCBs from the fish meal to the farmed species. This may reduce the available supply of “allowable” fish meal—fish meal that meets specific, certified guidelines—thereby impacting its price. Again, higher prices will stimulate the development of alternative protein sources that are both biologically and economically feasible.

#### *Additional Sources of Fish Meal and Fish Oil*

Aside from technological developments in the production of protein alternatives, the recycling of bycatch is another possible source to augment current supplies from reduction fisheries. The FAO recently estimated global bycatch and found that, based on global data over the last decade, the average amount of fish thrown back into the sea was 7.3 million metric tons (Kelleher, 2005). This is a reduction in the estimate made back in 1994, which estimated that average annual global fish discards were around 27 million metric tons (Alverson et al., 1994). Instead of being discarded at sea, bycatch could be redirected into the production of fish meal and fish oil, thereby augmenting current supplies. Fish processing byproducts, mainly the excess trimmings and wastes that result from processing fish for human consumption, could also be directed into fish meal and fish oil production.

#### *Implication for Offshore Aquaculture*

The offshore aquaculture industry may focus part of its efforts on the rearing of high-valued carnivores, such as salmon or cod. Carnivorous species currently require fish meals that incorporate some portion of fish meal and fish oil for nutritional requirements. This has implications for the long-term potential of the aquaculture industry. As the price of fish meal and fish oil rises due to increased demand, feed costs will also rise. Within the aquaculture sector, feed costs represent the largest cost of production. Thus, the economic viability of an offshore finfish aquaculture industry may be constrained or rendered economically infeasible due to the presence of prohibitively high feed costs.

Within salmon aquaculture, feeds and feeding costs represent between 50-70% of total farm production costs (Tacon, 2005; Guttormsen, 2002). For the two leading salmon farming producers, feed costs represented 45.8% (Chile) and 51.9% (Norway) of total production costs, and research by Engle and Killian (1997) estimated that feed costs represented 44.5% of total farm costs for U.S. catfish farmers in Arkansas (Anderson, 2003).

Given current forecasts, the demand for fish meal and fish oil will continue to increase as the general aquaculture sector continues its expansion. The argument that omnivores rather than carnivores should be raised to solve the “fish meal problem” is misguided, because omnivores currently consume fish meal. Fish meal and fish oil are essential ingredients in the early developmental stages of fry and juvenile omnivores (Hardy, 2005). Based upon the increasing



production levels of omnivores, they in fact consume almost half (46%) of the total available compound aquafeeds (Figure 4.8). Thus, even with the culture of omnivores and herbivores, small amounts of fish meal and fish oil will be used as secondary protein sources, due to their high quality.

This is concerning, given the level of carp production globally. As mentioned earlier, global carp production represented 31% of total aquaculture production in 2003. The results of Kristofferson and Anderson (2005) suggested that fish meal has unique nutritional properties that distinguish it from the general oilseed market. This implies limited substitution possibilities for fish meal and fish oil that may hinder the expansion of the industry across all species, including omnivores.

Gains in production efficiency (such as better feed formulations, better feed conversion ratios) will help reduce the quantity of fish meal required on a per-fish basis. Feed costs are a driver of overall production costs; therefore, producers will seek to lower these costs through various mechanisms. From a production perspective, better use of fish meal can come from improved feeds and feeding methods, both of which can help lower costs. Uneaten feed creates a two-fold problem: it is wasteful and therefore costly, and it accumulates under the cages, causing potential environmental problems in some locations. It is important to recall that price increases signal scarcity to the users of the resource, thus encouraging conservation and the innovation of new products.

Technological advancements will play an important role in expanding the knowledge of the nutritional and environmental requirements of various finfish species. These developments will also foster the development of alternative protein sources for use in both the terrestrial and marine-based protein producing sectors. The recycling of trimmings and bycatch can also help expand the available base of fish for fish meal production. Regardless, effective management will be vital in ensuring sustainable reduction fisheries for future generations.

## **Conclusion**

There has been considerable debate regarding the use of fish meal and fish oil as an input to the production of higher-valued finfish (Weber, 2003; Goldberg et al., 2001; Naylor et al., 2000; Goldberg and Triplett, 1997). In fact, the use of fish meal by the aquaculture sector is the most efficient use of the resource relative to other protein sources. The efficiency of feed conversion is greatest for finfish (30%) as compared to poultry (18%), pigs (13%), and sheep (2%) (Åsgård and Austreng, 1995). Furthermore, Åsgård and Austreng (1995) and Åsgård et al. (1999) demonstrated that 10 kg of capelin would produce 4.6 kg of farmed salmon, of which 3.0 kg were edible, as compared to 2.0 kg of wild cod, of which 0.7 kg were edible. Wild fish must expend extra energy in pursuit of prey as well as in defense from predators. Both activities require energy—energy that could otherwise be devoted to biomass growth. Thus, aquacultured species are able to produce more pounds of edible meat per quantity of feed consumed, compared to their wild counterparts. Again from a production standpoint, finfish offer a product with more edible meat per pound of live weight. Additionally, the finished product of finfish and shellfish typically contains a higher Omega-3 content than terrestrial proteins, such as pork, chicken and beef (USDA, 2005).

In poultry, the final yield of edible meat is less than 40% of live weight, with only about 15% of live weight being the premium breast meat and tender (Forster, 1999). In contrast, salmon yields approximately 60% of edible meat with the majority of this meat considered 'premium cut' (Forster, 1999).

Many countries derive extensive economic benefits from the existence of their reduction fisheries. If properly regulated, this industry is sustainable. A recent report commissioned by the European Parliament explicitly identifies the fish meal industry as a viable and sustainable industry. Within the executive summary, the report states: "Overall the industrial fishing of feed fish appears to be ecologically and socio-economically sustainable" (EP, 2004). The fish targeted by reduction fisheries are fish that have little to no demand for consumption by humans, due to their consistency and/or taste. They are well-managed fisheries that do not threaten the sustainability of the resource for future generations. A primary goal of all affiliated parties (reduction fishermen, feed manufacturers, agriculture and aquaculture producers, regulatory bodies, environmental groups, concerned scientists and citizens) should be the sustainable management of reduction fisheries for all users of fish meal and fish oil, which includes both the agriculture and aquaculture sectors.

## References

Alverson, D.L., Freeberg, M.H., Murawaski, S.A. & Pope, J.G. 1994. A global assessment of fisheries bycatch and discards. FAO Fisheries Technical Paper No. 339. Rome, FAO.

Anderson, J.L. 2003. International Seafood Trade. Woodhead Publishing Ltd., Cambridge, England.

Åsgård T., Austreng, E., Holmefjord, I. and M. Hillestad. 1999. Resource efficiency in the production of various species. In N. Svennevig, H. Reinertsen, and M. New (eds), *Sustainable aquaculture: food for the future?* Pp. 171-183. Rotterdam, Neatherlands, A.A. Balkema.

Åsgård T. and Austreng, E. 1995. Optimal utilization of marine protein and lipids for human interests. In: Reinertsen, E, Haaland, H. (eds). "Sustainable Fish Farming." *Proceedings from First International Symposium on Sustainable Fish Farming*, pp 79-87. Oslo, Norway.

Asche, F., and S. Tveteras. 2000. "On the relationship between aquaculture and reduction fisheries." Paper presented at the biennial meetings of the International Institute of Fisheries Economics and Trade, held in Corvallis, Oregon, 10–14 July, 2000.

Atlantic States Marine Fisheries Commission (ASMFC). 2007. Atlantic menhaden webpage. <http://www.asmfc.org/>

Barlow, S.M. 2002. "The World Market Overview of Fish Meal and Fish Oil." Paper presented to the Second Seafood By-Products Conference in Alaska, November 2002.

Connor, William E. 2000. Importance of n-3 fatty acids in health and disease. *American Journal of Clinical Nutrition* 71:171S-175S.

Eliseo Guallar, M. Inmaculada Sanz-Gallardo, Pieter van't Veer, Peter Bode, Antti Aro, Jorge Gómez-Aracena, Jeremy D. Kark, Rudolph A. Riemersma, José M. Martín-Moreno, Frans J. Kok, the Heavy Metals and Myocardial Infarction Study Group. 2002. Mercury, Fish Oils, and the Risk of Myocardial Infarction. *New England Journal of Medicine* 347:1747-1754.

Engle, C.R. and H.S. Killian. 1997. Costs of producing catfish on commercial farms in levee ponds in Arkansas. ETB 252. Cooperative Extension Program, University of Arkansas at Pine Bluff.

European Parliament (EP). 2004. The Fish meal and Fish oil Industry - Its role in the Common Fisheries Policy. FISH 113 EN, Feb 2004.

European Union (EU). 2001. Fact Sheet on Dioxin in Feed and Food. Brussels.  
[http://europa.eu.int/comm/dgs/health\\_consumer/library/press/press170\\_en.pdf](http://europa.eu.int/comm/dgs/health_consumer/library/press/press170_en.pdf)

Food and Agriculture Organization (FAO). 2005. FishStat Plus: Universal Software for Fishery Statistical Time Series.

FAO Globefish Commodity Update. 2005. Fishmeal-Fish oil. February.

Food and Agriculture Organization (FAO). 2004. "The State of World Fisheries and Aquaculture 2004." Rome, FAO.

Food and Agriculture Organization (FAO). 2000. "The State of World Fisheries and Aquaculture 2000." Rome, FAO.

Fishmeal Information Network (FIN) 2005a. <http://www.gafta.com/fin/fin.html>

Fishmeal Information Network (FIN) 2005b. Fin Dossier 2005: Annual review of the feed grade fish stocks used to produce fish meal and fish oil for the UK market.  
<http://www.gafta.com/fin/FINsustain.pdf>

Fishmeal Information Network (FIN) 2005c. Fish meal Facts and Figures  
<http://www.gafta.com/fin/finfacts1.html>

Fishmeal Information Network (FIN) 2005d. Contaminants in Fish and Fish Meal.  
<http://www.gafta.com/fin/findioxin.html>

Forster, J. 1999. Aquaculture Chickens: Salmon - A Case Study. *World Aquaculture* 30(3):33-40.

Goldburg, R.J., M.S. Elliott, R.L. Naylor. 2001. Marine Aquaculture in the United States: Environmental Impacts and Policy Options. Pew Oceans Commission, Arlington, Virginia.

Goldburg, R. and T. Triplett. 1997. Murky Waters: Environmental Effects of Aquaculture in the US. The Environmental Defense Fund Report.

Guttormsen, A.G. 2002. Input Substitutability in Salmon Aquaculture. *Marine Resource Economics* 17:91-102.

Gulf States Marine Fisheries Commission (GSMFC). 2007. Introduction.  
<http://www.gsmfc.org/menhaden/2002%20About%20Us.shtm>

Hardy, R. 2005. Fish Meal Myths Concerning Omnivorous Farmed Fish. *Aquaculture Magazine* 31(3):53-58.

International Fishmeal and Fish Oil Organization (IFFO). 2005a. Advantages of Using Fish Meal in Animal Feeds. <http://www.iffo.org.uk/tech/FM-Anim.pdf>

International Fishmeal and Fish Oil Organization (IFFO). 2005b. Industry Overview.  
<http://www.iffo.net/default.asp?fname=1&sWebIdiom=1&url=253>

Jorgensen, H., Sauer, W.C. and P.A. Thacker. 1984. Amino Acid Availabilities in Soybean-Meal, Sunflower Meal, Fish-Meal and Meat and Bone Meal Fed to Growing Pigs. *Journal of Animal Sciences* 58(4):926-934.

Jystad, P. T. 2001. Will high volume production spoil premium fish products? Intrafish.com, Industry report on fish meal and oil or vegetable alternatives.

Kelleher, K. 2005. Discards in the world's marine fisheries. An update.  
*FAO Fisheries Technical Paper*. No. 470. Rome, FAO.

Klasing, K.C. 1998. Nutritional Modulation of Resistance to Infectious Diseases. *Poultry Science* 77(8):1119-1125.

Kris-Etherton, P. M. Harris, W. S. Appel, L. J. 2002. Fish consumption, fish oil, omega-3 fatty acids, and cardiovascular disease. *Circulation* 106(21):2747-57.

Kristofersson, D. and J.L. Anderson. 2006. Is there a relationship between fisheries and farming? Interdependence of fisheries, animal production and aquaculture. *Marine Policy* 30:721-725.

Kromhout D, EBBosschieter EB, de Lezenne Coulander C. 1985. The inverse relation between fish consumption and 20-year mortality from coronary heart disease. *New England Journal of Medicine* 312:1205-1209.

Larraín, C., Leyton, P. and F. Almendras. 2005. Aquafeed country profile – Chile and salmon farming. *International Aquafeed*, 8(1):22-27.

- Makkink, C.A., Negulescu, G.Q., Qin, G.X., and M.W.A. Verstegen. 1994. Effect of Dietary Protein Source on Feed Intake, Growth, Pancreatic-Enzyme Activities and Jejunal Morphology in Newly-Weaned Piglets. *British Journal of Nutrition* 72(3):353-368.
- McPhaden, M. J. and N. N. Soreide. undated. "Frequently Asked Questions about El Nino and La Nina," Department of Commerce, National Oceanic and Atmospheric Administration, Pacific Marine Environmental Laboratory, Tropical Atmosphere Ocean Project.  
<http://www.pmel.noaa.gov/tao/elnino/faq.html>
- Naylor, R., Goldburg, R., Primavera, J., Kautsky, N., Beveridge, M., Clay, J., Folke, C., Lubchenco, R., Mooney H., and M. Troell. 2000. Effect of aquaculture on world fish supplies. *Nature* 405:June 29.
- New, M. B. and U.N. Wijkstrom. 2002. "Use of Fishmeal and Fish oil in Aquafeeds: Further Thoughts on the Fishmeal Trap." FAO Fisheries Circular No 975. Rome: Food and Agricultural Organization of the United Nations.
- New England Fishery Management Council. (NEFMC) 2007. Atlantic Herring Fishery Management Plan. <http://www.nefmc.org/herring/summary/herring.pdf>
- Official Journal of the European Communities (OJEC). 2005. Commission Regulation (EC) No 1292/2005. L 205/3. 6.8.2005. [http://europa.eu.int/eurlex/lex/LexUriServ/site/en/oj/2005/l\\_205/l\\_20520050806en00030011.pdf](http://europa.eu.int/eurlex/lex/LexUriServ/site/en/oj/2005/l_205/l_20520050806en00030011.pdf)
- Official Journal of the European Communities (OJEC). 2001. Commission Regulation (EC) No 999/2001. L 147/1. 31.5.2001  
[http://europa.eu.int/eur-lex/pri/en/oj/dat/2001/l\\_147/l\\_14720010531en00010040.pdf](http://europa.eu.int/eur-lex/pri/en/oj/dat/2001/l_147/l_14720010531en00010040.pdf)
- Pensack, J.M., Bethke, R.M., Kennard, D.C. 1949. The Effect of Fish Meal and Extracts of Fish Meal on Hatchability of Hens Eggs and Growth of Progeny. *Poultry Science*. 28(3):398-405.
- Pike, I.H. 2005. Eco-efficiency in aquaculture: global catch of wild fish used in aquaculture. *International Aquafeed* 8(1):38-40.
- Pike, I.H. and S.M. Barlow. 2002. "Impact of Fish Farming on Fish Stocks." Paper presented at Bordeaux Aquaculture and Environment Symposium. September 2002.
- Pike, I.H., Curran, M.K., Edge, M., and A. Harvey. 1984. Effect of Nutrient Density, Presence of Fish-Meal and Method of Feeding of Unmedicated Diets on Early Weaned Pigs. *Animal Production* 39:291-299.
- Seierstad, S.L., Seljeflot, L., Johansen, O., Hansen, R., Haugen, M., Rosenlund, G., Froyland, L. and H. Arnesen. 2005. Dietary Intake of Differently Fed Salmon: The Influence on Markers of Human Atherosclerosis. *European Journal of Clinical Investigation* 35(1):52-59.

Tacon, A.G. 2005. State of Information on Salmon Aquaculture Feed and the Environment. [http://www.westcoastaquatic.ca/Aquaculture\\_feed\\_environment.pdf](http://www.westcoastaquatic.ca/Aquaculture_feed_environment.pdf)

Tacon, A.G. 2004. Use of Fish Meal and Fish Oil in Aquaculture: A Global Perspective. *Aquatic Resources, Culture and Development* 1(1):3-14.

U.S. Department of Agriculture, (USDA) Agricultural Research Service. 2005. USDA Nutrient Database for Standard Reference, Release 18. Nutrient Data Laboratory Home Page, <http://www.nal.usda.gov/fnic/foodcomp>

Vukina, T. and Anderson, J. L. 1993. A State-Space Forecasting Approach to Optimal Intertemporal Cross-Hedging. *American Journal of Agricultural Economics* 75:416-424.

Weber, Michael. 2003. What Price Farmed Fish: A review of the environmental and social costs of farming carnivorous fish. SeaWeb Aquaculture Clearinghouse.

Woodman, H.E. and R.E. Evans. 1951. Nutrition of the Bacon Pig.14. The Determination of the Relative Supplemental Values of Vegetable Proteins (Extracted, Decorticated Ground Nut Meal) and Animal Protein (White Fish Meal). *Journal of Agricultural Science* 41(1-2):102-140.

Wray, T. 2001. Making the most of jack mackerel. *Seafood International*, July 2001, pp.39-43.

Zaldivar, M.J. 2004. "Review of the commercial situation of fishmeal and fish oil and the new requirements imposed on them." Paper presented at Tecnica Aqua Sur 2004 (Chile), March 2004. <http://www.iffco.org.uk/tech/TecnAqua.htm>

## CHAPTER 5

### Lessons from the Development of the U.S. Broiler and Catfish Industries: Implications for Offshore Aquaculture in the United States

Gina Shamshak and James Anderson

---

*This chapter examines the emergence and development of the U.S. broiler and catfish industries. A brief overview of each industry, along with key factors associated with each industry's success, is identified and discussed. Reflecting on the two industries presented, some important lessons emerge that can be applied to the development of a U.S. offshore aquaculture industry. This chapter will explore those lessons and discuss their relevance with regard to the emergence of an offshore aquaculture industry in the U.S.*

#### **Brief Case Study of the United States Broiler Industry**

##### Introduction

Before the advent of the broiler industry, chicken meat was strictly a byproduct of the egg industry (USDA/NASS, 2002). Today, the U.S. broiler industry is the world's largest producer and exporter of poultry meat (USDA/NASS, 2005). Some of the key factors attributed to the industry's success include: contract growing, vertical integration, enhancements in nutrition, advances in disease control, and improvements in broiler production, processing, and marketing (Watts and Kennett, 1995). Collectively, these advancements contributed to the growth and development of this industry. Production increased more than ten-fold from 1934-1945; it nearly tripled the following decade; and it more than doubled from 1955-1965 (Figure 5.1). Due to its ability to expand and evolve rapidly, the industry rose from non-existence to one that provided a key staple of the American diet by the latter third of the century. The per-capita consumption of chicken now stands at 81.1 pounds, greater than beef (62.0), pork (48.5), and seafood (16.3) (USDA/ERS, 2004a; NMFS, 2005). Furthermore, the gap between the per-capita consumption of chicken and the per-capita consumption of all red meats (pork, beef, lamb, and veal) has been steadily narrowing (Figure 5.4).

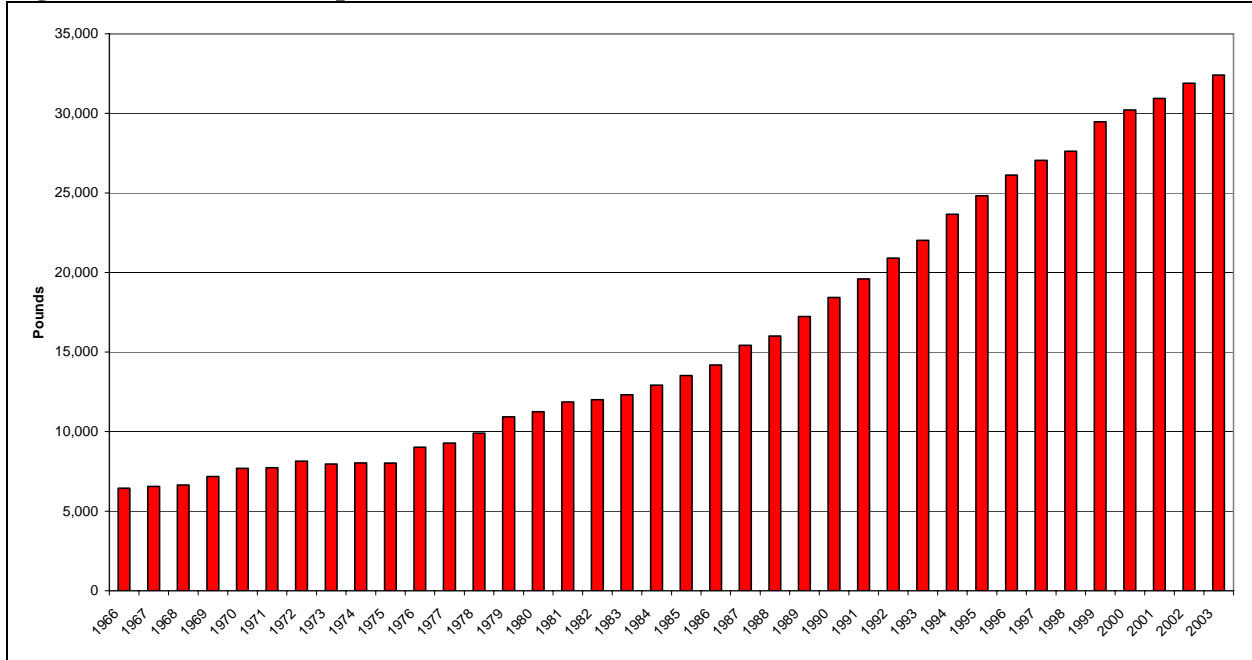
##### Industry Development

The industry has evolved from millions of small backyard flocks to less than 50 highly specialized, vertically-integrated agribusiness firms (USDA/NASS, 2002). One can see the transition to a highly organized and integrated industry by examining the evolution of the number and capacity of chicken hatcheries. In 1934, 11,405 facilities hatched all of the U.S. chickens; by contrast, in 2001 that number had dropped to 323 hatcheries (USDA/NASS, 2002).

In the early years of the industry, the majority of broilers were bred and produced in New England. Today the majority of this production is centered in the southeastern U.S. around the top five producing states: Georgia, Arkansas, Alabama, Mississippi, and North Carolina. In 2004, the U.S. broiler industry produced 34.1 billion pounds of meat with a retail equivalent value of 43 billion dollars. The United States is the world's largest exporter of broilers. In 2004, broiler exports totaled 4.8 billion pounds (15% of total production), and were valued at \$1.7 billion (USDA/ERS, 2005). While the volume of product may seem small relative to total production, the value of broiler exports (\$1.7 billion in 2004) is greater than the value of the

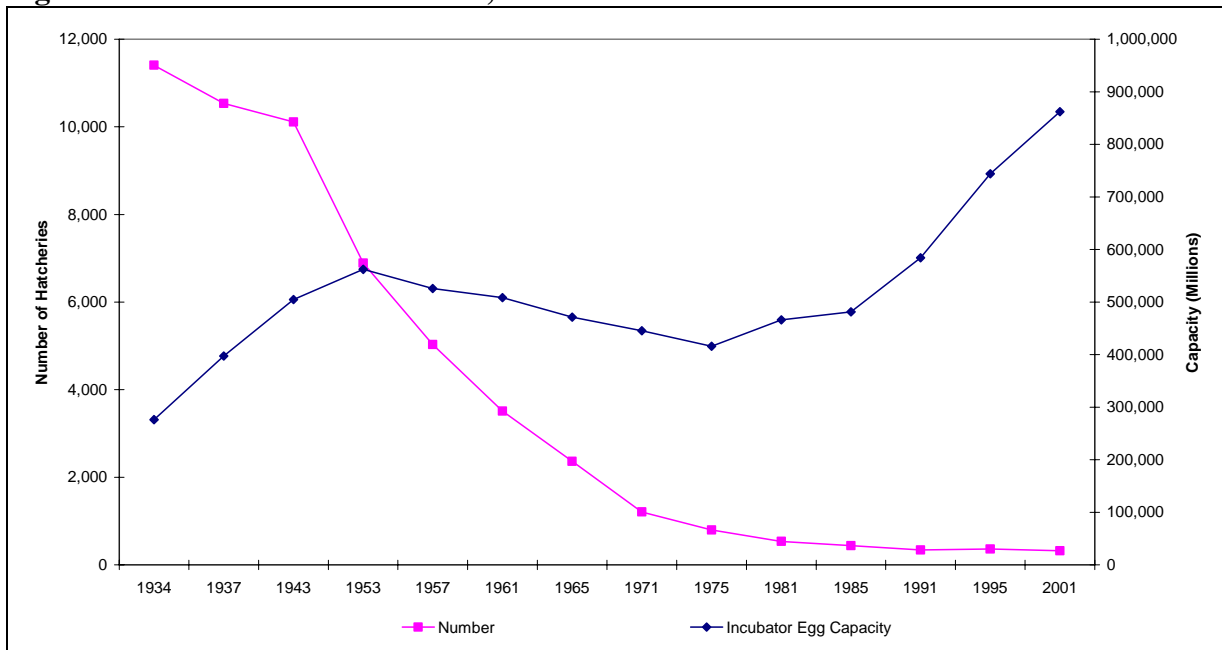
entire U.S. aquaculture industry, which is approximately \$1 billion. In contrast, the U.S. imports a very small amount of broiler products, accounting for less than 1% of domestic production (USDA/ERS, 2005).

**Figure 5.1. U.S. broiler production, 1966-2003.**



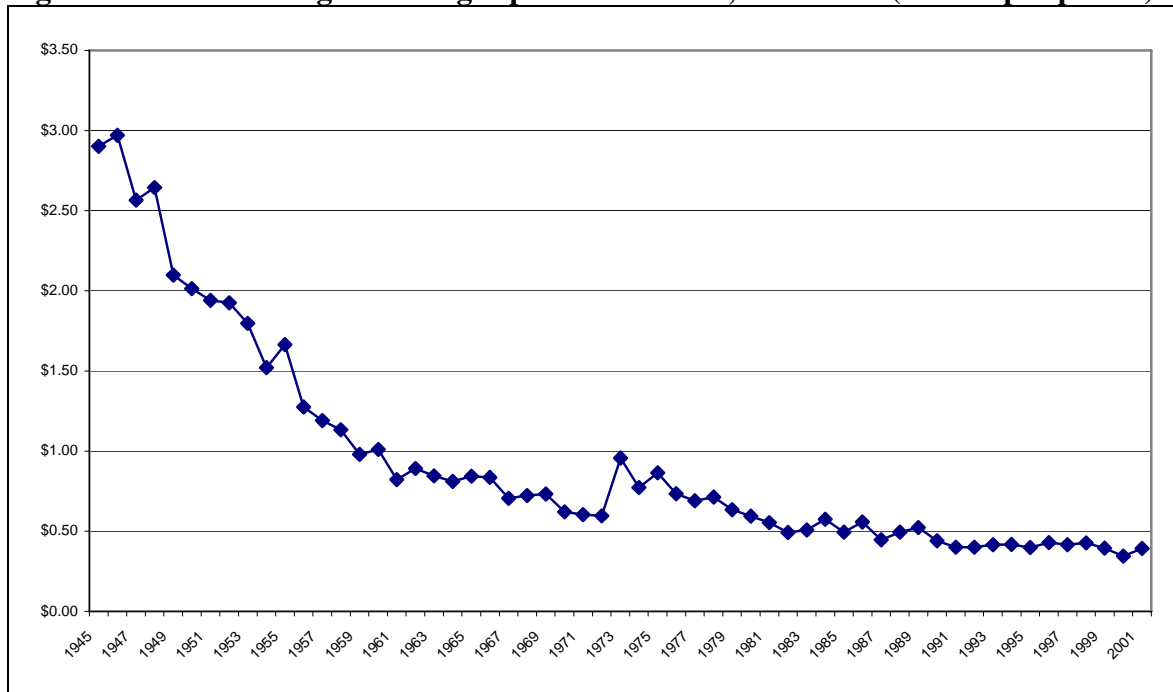
Source: USDA/ERS, 2004

**Figure 5.2. U.S. chicken hatcheries, 1934-2001.**



Source: USDA/NASS, 2002



**Figure 5.3. Real average live weight price of broilers, 1945-2001 (dollars per pound).**

Source: USDA/NASS, 2002

Note: \*Nominal Prices converted to 2001 dollars by the Bureau of Labor Statistics Consumer Price Index (All Urban Consumers 1982-84=100)

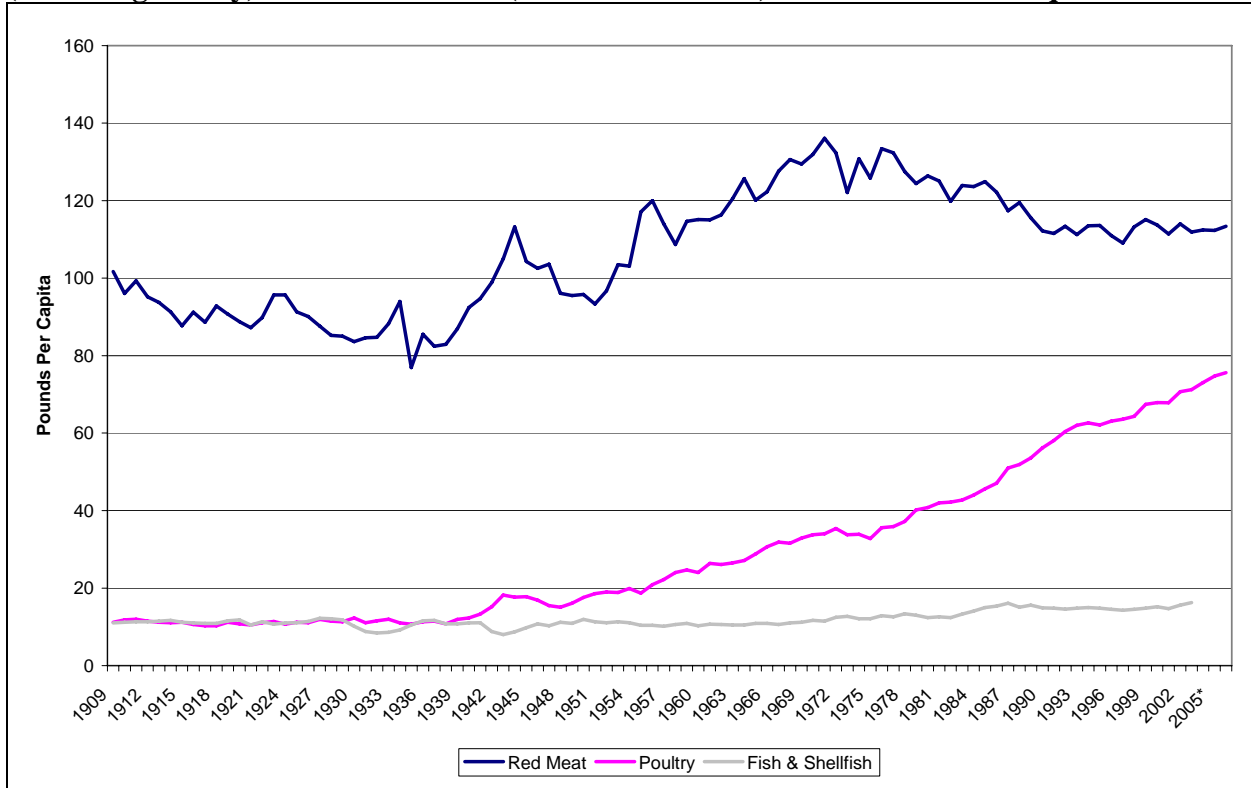
The total farm value of U.S. poultry production in 2003 was \$23.3 billion and broiler production accounted for \$15.2 billion of that value. While the nominal price per pound has remained essentially constant, the real price of broilers per pound has fallen 85% since 1946. Through its amazing expansion, the broiler industry has been able to catch up with and surpass both per-capita pork consumption in 1986 and per-capita beef consumption in 1993 (USDA/ERS, 2004a). The per-capita consumption of total red meats, which includes beef, pork, veal, and lamb is still greater than the per-capita consumption of total chicken, which includes both young chickens (broilers) and other chicken, although the gap between the two is steadily narrowing (Figure 5.4).

### Key Factors in the Industry's Development

#### Automation

Automation in processing signaled a major development in the industry. During this period, the industry became more capital intensive, as workers were replaced by machines that could process birds more quickly and efficiently. According to the U.S. Department of Labor, Bureau of Labor Statistics, productivity in poultry processing doubled in the 20-year period from 1973 to 1992 (Watts and Kennett, 1995). This increased efficiency in production led to a significant increase in the supply of broilers in the market, which was also a contributing factor in the decline of live weight, price per pound of broilers. The end result of this over-supply was consolidation in the industry, as operating losses mounted for many firms.

**Figure 5.4. Per-capita consumption of total red meat (pork, beef, lamb, veal), total chicken (excluding turkey) and total seafood (finfish & shellfish) boneless trimmed equivalent.**



Source: USDA/ERS, 2004a; NMFS, 2005

*Improved Husbandry Techniques*

Improvements in husbandry techniques also led to industry expansion. Broiler growth rates improved as vitamins, antibiotics, high-energy diets, and the inclusion of different amino acids became more prevalent. If one were to compare the diet of a broiler in 1912 to the diet of a broiler in 1958, the same three-pound broiler would mature 34 days sooner on the 1958 diet (44 days) as compared to the 1912 diet (78 days) (Watts and Kennett, 1995). Today, that figure has been reduced to less than 42 days for a three-pound broiler (Bell, 2005).

Disease also played a major role in development of the industry. During the 1920s and 1930s, two major diseases hit the broiler industry: pullorum and coccidiosis. Initially, these diseases devastated producers, some of whom experienced broiler mortality rates of 50% (Watts and Kennett, 1995). Over time, both of these diseases were brought under control through the use of antibiotics, enhanced diet formulas, and improved husbandry techniques.

A more recent threat to the industry has been avian influenza (AI), which is classified as either low pathogenic (LPAI) or highly pathogenic (HPAI) depending on the severity of the illnesses they cause (USDA/APHIS, 2001). Birds infected with LPAI may show few or no clinical signs of infection; however, birds infected with HPAI can quickly succumb to this extremely infectious and fatal disease, often without warning. Humans have also been susceptible to certain strains of the HPAI virus. In 1997 in Hong Kong, a strain known as H5N1 infected chickens as well as 18 humans—6 of whom later died. Domestically, a major outbreak

of HPAI occurred in the Northeast United States in 1983-1984 and resulted in the destruction of more than 17 million birds. This disease cost the industry nearly \$65 million and caused retail egg prices to increase by more than 30% (USDA/APHIS, 2001). More recently in 2004, an outbreak of HPAI occurred in Texas, while outbreaks of LPAI occurred in Delaware and New Jersey. The rapid spread of HPAI, especially in Asian regions, has stimulated concern for both animal and human health (USDA/APHIS, 2001). Both globally and locally, animal and human health organizations are actively monitoring both domestic flocks and imported birds for the disease in the hopes of minimizing potential outbreaks, especially since most experts agree that another influenza pandemic is “inevitable and possibly imminent” (WHO, 2004).

### Vertical Integration

Through the use of contract growing, the broiler industry has reduced costs and improved the quality and value of the final product. The prevalent contractual agreement in the broiler industry can be broken down as follows. Individual companies, also known as “integrators,” own and control a large portion of the production process. They typically own the breeder flocks, hatcheries, feed mills, and processing plants, leaving the actual grow-out process to individual farmers. The integrators are responsible for the provision of chicks, feed, medication, and sometimes fuel used in the brooding process. In addition, integrators provide representatives from the company to administer field supervision and technical advice to the farmers. This high level of involvement in the production process helps ensure that farmers consistently provide a high-quality product that meets specific company standards.

On the other side of this agreement is the individual farmer, or producer, as he or she is known, who provides the growing facilities, equipment, labor, fuel and electricity, and day-to-day supervision of the chicks until slaughter. Broiler farms are required to be located within a certain number of miles away (25-35 miles) from key facilities such as feed mills, processing plants, and hatcheries. This restriction helps reduce transportation costs across the various stages of production. When the birds are ready for slaughter, the producers receive a payment corresponding to the pounds produced plus a bonus based upon a performance ranking against other producers. Often, producers are ranked based upon an average production cost per pound for all flocks sold during a given week (Cunningham, 2002). A common arrangement is 3.8 to 4.6 cents per pound of live weight plus 0.01 cents per pound for each 0.01-point advantage (relative to the average) that a grower achieves in production costs (Cunningham, 1999). This sort of arrangement benefits both parties because it helps reduce risk on the producers’ side and helps ensure quality and consistency of product on the integrators’ side.

As the industry transitioned from whole chickens to de-boned, highly-processed and value-added products, the need for consistency in size and quality heightened. This is especially true in the mechanical processing of the birds, since automated machines cannot easily adjust to various sized birds. Furthermore, consumers demand a consistent, reliable product in the marketplace, and heterogeneity on the production line only hinders the ability of firms to provide a consistent product. A major benefit of the contractual arrangement between processors and producers is the inherent risk sharing across the entire production process. With their roles and expectations clearly defined, farmers and processors are able to devote time and resources toward long-term investments and improvements in their production processes rather than

behaving more myopically. By reducing the amount of risk each faces, more optimal decisions can be made across the entire planning horizon.

### Research and Development

A major development in the broiler industry was the “Chicken of Tomorrow” competition. In 1944, Howard C. “Doc” Pierce, national research director for A&P Food Stores, discussed at a Canadian poultry meeting the need for development of a broad-breasted chicken similar to the broad-breasted turkey (Watts and Kennett, 1995). Soon after that meeting, a nationwide competition was established. National finalists were assembled from the winners of 40 state and regional contests during 1946 and 1947. The national final was held in Georgetown, Delaware in 1948. Contestants sent two cases of eggs to the organizers of the national competition so that all of the eggs could be hatched, fed, grown, slaughtered, and processed as “New York Dressed” under identical conditions. USDA officials conducted a thorough inspection of the meat for quality and consistency characteristics, and the winning contestant was presented with a cash prize. The contest was so successful that, in 1951, another competition was held. This competition was critical to development of the industry, because it helped the broiler industry establish itself as an industry of its own. From now on, broilers were no longer considered a mere byproduct of the egg industry, and the so-called dual purpose bird became virtually extinct (USDA/ERS, 2001; Watts and Kennett, 1995).

### Industry Collaboration

Industry leaders realized the importance of a common, unified voice and a strong marketing campaign. Created in 1954, the National Chicken Council’s (NCC) three principal activities are in the areas of: public affairs, consumer education/public relations, and membership services. According to its website, the NCC’s primary purpose is to “represent the interests of the broiler industry in Washington” (NCC, 2005). The industry also collaborated through the NCC to stimulate greater consumer demand. The NCC devotes 40% of its budget “to promote the use of chicken and maintain a positive image of the industry.” It sponsors events and contests such as the National Chicken Cooking Contest and it publishes “The Chicken Cookbook,” both of which promote chicken consumption.

### Future Outlook

Over time, two outlets for the broiler product—the fast food market and export market—emerged. These two channels did not exist in the early years of the industry. Growth in these two channels is expected to remain strong. The development of further processed convenience foods—such as value-added products like boneless breasted meats and thighs, batter-breaded fried parts, patties, and nuggets—continues to open up new markets for the broiler industry.

Domestically, chicken consumption is forecasted to remain strong, especially given the per-capita consumption of broilers over time, relative to other protein sources (Figure 5.4). Furthermore, global demand for chicken products is expected to remain strong, which is encouraging for U.S. producers, given that the U.S. is the world’s largest exporter of broilers. The real, live weight price per pound has remained stable for the past 14 years, averaging 40 cents per pound over that period. Provided there are no major disease outbreaks, such as avian influenza, to disrupt the supply of broilers on the market, the average price per pound will most likely remain stable. The U.S. broiler industry does not face any serious foreign competition

from imports, and the industry has done a relatively good job of coordinating production to minimize supply gluts.

Costs will play an important role in the industry; especially if feeds costs, and in particular fish meal prices, rise. Feed costs represented 60% of total production costs for young chicken farm production, measured on a live weight basis in 2002 (USDA/ERS 2004b). Over the past 20 years, feed costs have averaged 63%, fluctuating between a high of 70% in 1984 and a low of 58% in 1999 (USDA/ERS 2004b). Energy costs will also play an important role as the cost of a barrel of oil continues to rise. Despite the potential for shrinking profit margins on the cost side, the outlook for the industry remains strong.

## **Brief Case Study of the United States Catfish Industry**

### Introduction

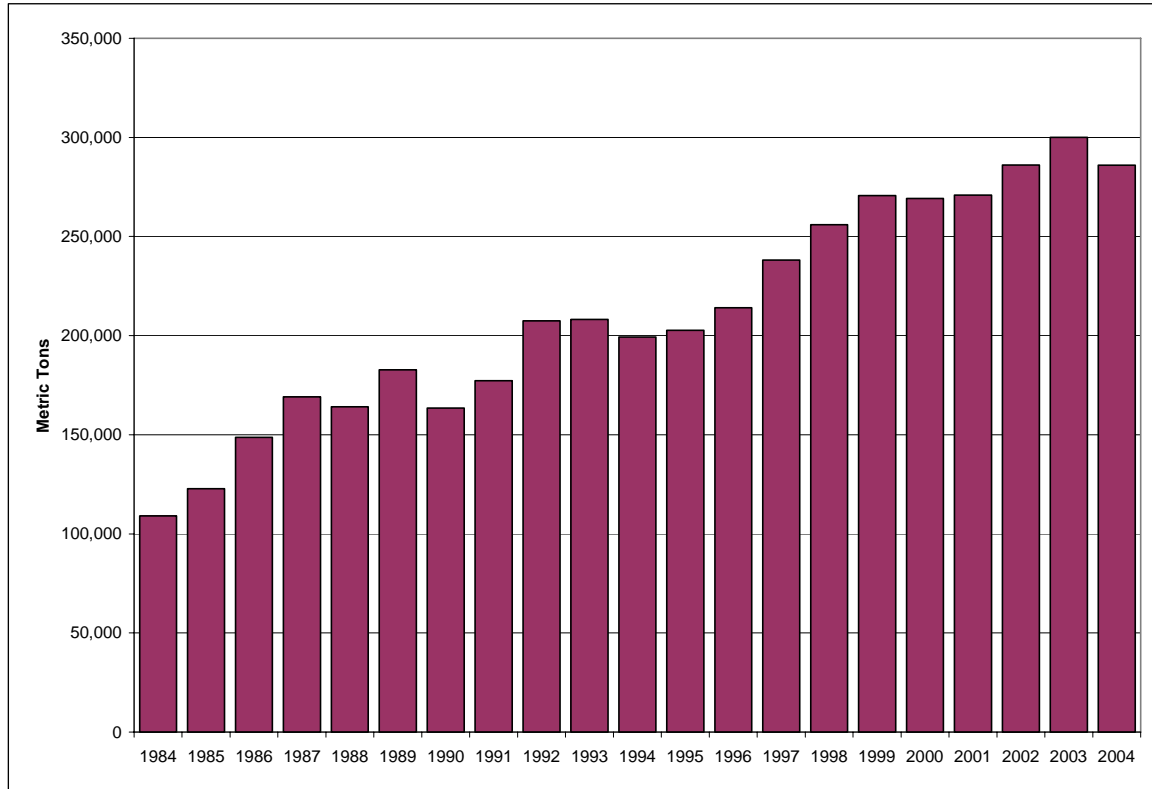
The U.S. catfish industry expanded from a local, specialty species to a product with national appeal by developing strong partnerships with local government and universities and by collaborating as an industry to brand its product. The end result has been an industry that contributes to the local economy and competes with foreign producers. The industry has expanded from a relatively small, wild fishery to the largest sector within the U.S. aquaculture industry. There has been a greater than four-fold increase in production from 62,256 metric tons (mt) in 1983 to 285,967 mt in 2004 (Figure 5.5). This level of production places the U.S. catfish industry third behind the Alaska walleye pollock (1,519,928 mt) and menhaden (679,311 mt) in total U.S. seafood production in 2004.

When measured by value, however, the U.S. catfish industry ranks first (\$438,845,737) among all species produced (including all wild-capture and farmed species), followed by American lobster (\$365,749,516), sea scallops (\$320,975,956) and Alaska walleye pollock (\$271,424,181). Consumers can now find catfish in almost every major supermarket chain across the country. This broad availability stands in stark contrast to the product's availability 20 years ago, when one would not have seen catfish outside the southeastern United States.

### Industry Development

The modern catfish farming industry originated in the Mississippi Delta during the late 1960s and early 1970s. Local farmers desired to diversify their farms, and they sought alternatives to the more prevalent, low-priced row crops grown in clay-based soils (Dean et al., 2003). The near-level land surface and abundant groundwater found in the Delta gave the area a natural advantage in the production of channel catfish (*Ictalurus punctatus*). In addition, proximity to the Mississippi River allowed for the relatively cheap transport of grain from the Midwest and Southeast. Traditionally, catfish were harvested in local lakes and rivers by small-scale commercial fishermen.

This industry has emerged from a small, capture-based industry serving local markets to a large aquaculture industry that has expanded to national and international markets. Channel catfish farming is the fastest growing segment of the aquaculture industry in the United States (Lewis and Shelton, undated). Today, there are 196,590 acres of catfish in the United States and 111,500 of those acres are in Mississippi (Dean et al., 2003).

**Figure 5.5. U.S.-farmed channel catfish production.**

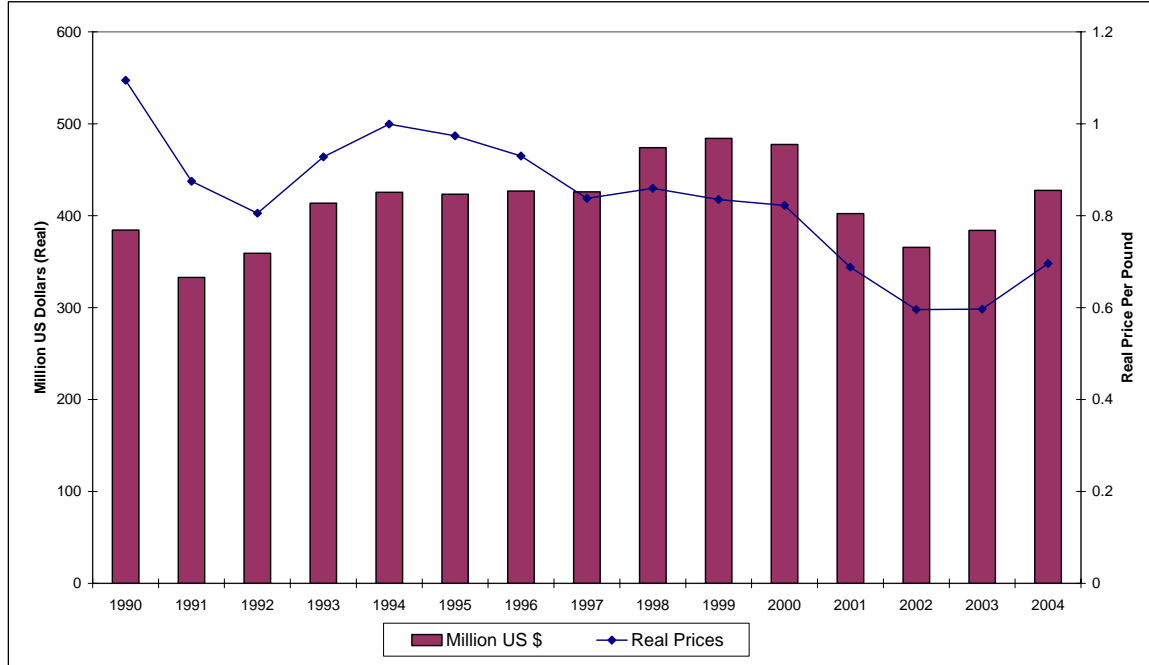
Source: FAO (2005), USDA/NASS (various years)

Catfish production grew from 98,300 metric tons in 1983 to 285,967 metric tons in 2004 (Figure 5.5). Mississippi's farm-raised catfish industry is a world-class example of a commercial aquaculture industry that is profitable, sustainable, and environmentally sound (Dean et al., 2003). Catfish has also gained popularity with consumers, who have increased per-capita consumption of catfish from 0.70 pounds in 1990 to 1.091 pounds in 2004 (NFI, 2005). According to research conducted by H.M. Johnson & Associates for the National Fisheries Institute, domestic consumption of catfish has ranked among the top five in seafood per-capita consumption since 1998.

The gross value of the U.S. catfish industry has averaged \$414 million over the past 15 years; however, the value of the industry in real terms in 2003 was essentially identical to the value of the industry in 1990 (Figure 5.6). One factor contributing to this situation has been the declining price per pound farmers have received at the farm gate. In real terms, the price per pound has fallen 36% from its 1990 level. Many factors contributed to the decline in farm-gate prices. Domestically, production levels increased—flooding the market with catfish and thereby driving prices down. During this supply glut, farmers also saw production costs increase, which further shrunk already narrowing profit margins. Feed costs can account for 52-54% of total annual operating costs; therefore, any increase in the cost of feed has a significant impact on overall production costs for each farmer (Engle, 2005). By mid-June of 2005, feed costs had fallen from highs of \$310 a ton to \$230 a ton for 32% protein feed, and farm-gate prices were on the rise (Coblentz, 2005). The easing of the cost-price squeeze is certain to help farmers in the

short run, as they regain some cash flow to pay debts and possibly increase investment in their operations.

**Figure 5.6. Value of U.S. channel catfish aquaculture and farm-gate prices paid to farmers, all adjusted for inflation.**



Source: USDA/NASS (various years), FAO (2005)

In an effort to address the impact of foreign competition, trade sanctions were imposed on Vietnam to restrict the labeling of Vietnamese catfish to “tra” (*Pangasius hypophthalmus*) or “basa” (*Pangasius bocourti*) in an attempt to reduce direct competition with U.S.-raised channel catfish (*Ictalurus punctatus*). Concerns still exist regarding foreign competition. Recent revisions in the estimates of catfish imports by the USDA/NASS show that more Vietnamese catfish entered the U.S. market than had been previously thought. Despite the ruling that required Vietnamese catfish be labeled either “tra” or “basa,” regulators are finding that catfish fillets are now being imported as frozen fillets of fish, frozen fillets of freshwater fish, and frozen fillets of sole (Bennett, 2003). Previously, the USDA was only reporting Vietnamese catfish imports that fell under the category of frozen fillets of catfish. This revision, then, actually increased the quantity of Vietnamese catfish that entered the U.S. market. In a perverse way, therefore, the new labeling requirement has compromised the ability of regulators to track Vietnamese catfish.

Often, foreign producers have a cost advantage over domestic producers—who are constrained by many factors, including access to credit and environmental regulations. Little can be done to prevent the exportation of technology and expertise to more business-friendly locations, where there is greater access to credit, labor costs are lower, and regulations do not hinder development of the industry.

## **Key Factors in the Industry's Development**

### Research and Development

During the 1920s, channel catfish were cultured in hatchery ponds of many state and federal facilities (Hargreaves, 2002). This knowledge, coupled with extensive state and university training for individual farmers helped foster the industry's success. Research scientists affiliated with the U.S. Department of Fish and Wildlife Service's Fish Farming Experiment Station in Stuttgart, Arkansas, and Auburn University provided the technical information, culture guidelines, and technical advice necessary to initiate industry development (Hargreaves, 2002). Federally-supported research conducted at state land-grant institutions throughout the region provided critical technical support and outreach to the industry (Hargreaves, 2002).

### Industry Leadership

Significant collaboration took place within the catfish industry, vital to its success. The Catfish Institute and the Catfish Farmers of America are two major associations that formed with the purpose of promoting and protecting the U.S. channel catfish industry. Since its creation in 1986, The Catfish Institute has effectively marketed channel catfish nationally, with Americans doubling their per-capita consumption of U.S. farm-raised catfish since 1986. The Institute has been dedicated to increasing demand for channel catfish by promoting the positive attributes of farm-raised catfish to consumers and food service professionals through advertising and other promotion programs (Hargreaves, 2002). This non-profit corporation derives its revenues from member feed mill dues to fund its national and international marketing campaigns. Established in 1987, feed mill dues were set at \$6/ton and, to date, more than \$30 million has been invested in The Catfish Institute (Hargreaves, 2002). This joint marketing effort effectively raised public awareness of catfish.

### Vertical Integration

This catfish industry has enjoyed some degree of vertical coordination since its inception. The industry developed from agricultural roots and formed cooperatives. In addition, it benefits from a relatively strong trade organization (The Catfish Institute) and it has support from the USDA Extension Service. To a large extent, the industry has avoided the bureaucracy and regulatory complexities that characterize traditional fisheries and coastal aquaculture. Its inland location resulted in the development of high quality fish processing facilities instead of dependency on processing plants used by traditional fisheries.

Catfish processing plants have established contractual arrangements with individual farmers. Approximately 93% of all catfish produced are sold to processing plants (USDA/NASS, 2003), and one arrangement between producers and processing plants requires the farmer to own stock in the processing company. Then, the amount of fish (often in weight) that the farmer can sell to the processing plant is related to the number of shares held. Another arrangement is a "feed for fish" program where plants agree to purchase fish from farmers who purchase feed directly from the company's feed mill (Engle, 2003). Finally, some plants sell delivery rights (frequently \$0.15 to \$0.20 per pound) that allow the farmer to sell the total weight equivalent of the volume of delivery rights purchased (Tucker et al., 2004).



### Expanding Markets

This industry has successfully marketed their product throughout the United States. They have done this by highlighting its many attributes and by providing the product in a variety of value-added forms. The industry has been able to reasonably manage the market, and prices for catfish have remained essentially stable over the past decade (Figure 5.6). Note that a decline in prices (2001-2003) is largely attributed to imports of “tra” and “basa” from Vietnam (USITC, 2003). In addition, production costs have remained relatively stable over that same time period.

### Protection from Foreign Competition

During the early 2000s, the U.S. catfish industry experienced significant competition from foreign producers, especially Vietnam. This increase in supply significantly decreased farm-gate prices received by U.S. producers. Through legislative and judicial rulings, the Catfish Farmers of America successfully united against direct competition from Vietnamese catfish producers. In 2002, Congress restricted the use of the word “catfish” to strictly refer to catfish from the *Ictaluridae* family, thereby requiring Vietnamese catfish to instead be labeled “tra” or “basa.” More importantly, the Catfish Farmers of America won an anti-dumping suit against Vietnamese producers in 2003, resulting in a country-wide tariff of 64% on Vietnamese “tra” and “basa” imports. As a result, “basa” imports have fallen 50% since the tariffs went into effect in June 2003 (Klinkhardt, 2004). The important lesson to be learned from the catfish industry is that, despite being comprised of many small farms, producers have successfully banded together as a powerful political and industry force.

## **Lessons for the U.S. Offshore Aquaculture Industry**

Reflecting on the two industries presented here, some important lessons emerge that can be applied to the development of a U.S. offshore aquaculture industry. One key similarity between both industries was the presence of strong and well-defined property rights (discussed below). Both industries evolved through increases in economic efficiency, including innovations in institutional structure and markets. Research and development—funded through both public and private investment—increased the technical efficiency of the industry. And finally, the government played a role in fostering or hindering industry development.

### Establishment of Well-defined Property Rights

Property rights are a fundamental component of the U.S. agricultural system. The hallmarks of strong property rights include the following: 1) the ability to exclude access and retain net benefits; 2) a high level of security; 3) a long duration; and 4) a high degree of transferability. Within the agricultural sector, property rights allow farmers the legal right to exclude others, thereby limiting the dissipation of rents (benefits) that commonly occurs in unregulated common property resources such as open-access fisheries. The property right is well defined in the sense that, not only does the owner have the legal right to exclude others, but a legal system is in place that supports and enforces this right. The security of the property right is strengthened because there is a system to protect and enforce the property right.

Another important feature of property rights is exclusivity of the right. Exclusivity grants the holder sole control over the property right. Under strong property rights, all decisions and access to the property are controlled by the owner. With well defined property rights,

externalities are internalized and net benefits are captured. Additionally, those that produce externalities that infringe on the property right are held responsible.

Durability is the third feature of well-defined property rights. Durability refers to length of ownership. Typically, strong property rights have a long duration; in some cases, in perpetuity. Short-term property rights are weaker in the sense that they encourage more exploitation of the resource. In this case, owners of the property right have the incentive to behave more myopically, which implicitly raises the discount rate.

The final feature of well-defined property rights is transferability. The ability to sell or transfer the property to another individual is important for two reasons. First, the owner has exclusive control of the property, and with transferability, he or she can transfer the property right with compensation, thereby capturing the value of the property right. A second key feature of transferability is the ability to use the property right as collateral. Since the property right is under the exclusive control of an individual and it has a market value, it is recognized as an asset by lending institutions. The ability to use an agricultural operation as collateral is significant because it allows the owner the ability to acquire financing. This is a critical feature that is not available to aquaculturists in the U.S., whose operations exist on short-term leases that have no market value because they cannot be transferred.

Well-defined property rights are crucial to the development of any industry, because they provide the economic incentives to engage in long-term planning and investment. Producers become more forward looking, invest in new technology, and attempt to gain control of their production and marketing systems. When property rights are insecure, regardless of whether the reason is crime, civil unrest, war, government instability, or government's aggressive use of eminent domain, the resulting dis-incentive is the same. Uncertainty causes owners to be more exploitive with resources, neglecting future costs and long-term investment opportunities in favor of short-term (and most likely, sub-optimal) returns.

In contrast, stronger property rights encourage the owner to make decisions over a longer planning horizon, thereby allocating resources more efficiently and using the resource more sustainably. In essence, strong property rights encourage owners to become strong stewards of the resource. When the government establishes well-defined and strong property rights, sustainability and success are more likely. Thus, for the development of an offshore aquaculture industry, the emphasis should be on creating a business environment where property rights are well defined and enforced. The government should set up and ensure well-defined property rights through the establishment of a transparent and expedient permitting and zoning system, and then allow farmers the ability to operate much like their agricultural counterparts.

Currently, the permitting process is unnecessarily complicated, costly, and time-consuming. Defining the rights and responsibilities of property is an essential first step. Governing institutions need to take responsibility for establishing, protecting and enforcing property rights as a primary responsibility. The emergence of research, investments, and complementary industries will follow, not precede, the establishment of well-defined property rights. Therefore, the focus should be on establishing a process for the creation and

implementation of property rights which will pave the way for the emergence of the following, ancillary factors.

*Role of Increased Economic Efficiency*

Establishment of well-defined property rights can increase the economic efficiency of an industry. As discussed above, this can manifest in longer operating horizons, better use and management of a resource, and higher levels of investment in capital and technology. Additional forms of economic efficiency can also improve performance of an industry. Within both the poultry and catfish industries, contracts play an important role in diversifying risks, thereby increasing the efficiency and functionality of the markets within both. Contracts allow farmers from both industries some protection from price risks. With this limited protection, a farmer is able to make better investment decisions rather than behave more myopically, due to a perceived level of risk he or she would bear alone.

Consolidation and vertical integration were also key drivers in each industry. Vertical integration allowed producers to reduce risk across the various stages of production by collecting those stages under one company. Vertical integration also allowed companies to better control their chain of production, from chicks or fingerlings to the final fillet, thus meeting the needs of a consumer who demands a consistent, high-quality product in the marketplace. While this may have resulted in fewer and larger companies, it also helped ensure a smoother production process, with a high-quality and higher-valued final product. Significant production risk will reduce the efficiency of the industry, due to an inability or an unwillingness to make appropriate capital investments because of an uncertain business climate. This especially impacts complementary investments in ancillary industries, such as hatcheries and feed production plants.

To date, a critical issue for the U.S. aquaculture industry has been the availability of broodstock from hatcheries. On both coasts, offshore producers have had difficulty acquiring steady, high quality supplies of fingerlings. This problem relates back to a lack of well-defined property rights and the current problems associated with offshore zoning and permitting in the U.S. Persistence of this problem has serious implications for the viability of the industry. The establishment of well-defined property rights will help encourage the development of both the offshore industry and the related ancillary industries, such as processing facilities and feed manufacturers.

Another example of how the U.S. broiler and catfish industries increased the economic efficiency of their industries was through the formation of industry groups that unified their voice and provided strength both in the marketplace and in the courtroom. The aquaculture industry has faced constant opposition from environmental groups, and this opposition has only grown stronger with the emergence of offshore aquaculture as a potential alternative to near-shore or land-based aquaculture operations. The aquaculture industry would benefit from forming a common voice that can counter these criticisms and provides balance to the arguments. A common voice could help the industry gain acceptance from consumers and improve its marketing potential.

Industry collaboration was an important factor in improving the economic performance of both the poultry and catfish industries by improving the markets that each industry faced. In the case of U.S. catfish, the industry formed The Catfish Institute to carry out generic advertising programs and public relation activities to promote catfish consumption (Engle and Quagraine, 2006). In the case of the U.S. broiler industry, marketing was company-specific, owing to the more consolidated and vertically-integrated nature of the industry. Regardless, each industry was able to essentially grow markets where they previously did not exist.

As the U.S. offshore aquaculture industry develops, direct competition with foreign producers will surely occur and challenge the profit margins of U.S. producers. The majority of aquaculture occurs internationally; therefore, the U.S. is already at a competitive disadvantage, given differences in labor costs and environmental regulations relative to other countries. Furthermore, the current situation regarding the issuance of permits in the U.S. places the industry at further disadvantage, given those additional costs—both in terms of time and money. The U.S. aquaculture sector will have to be innovative in both their production processes and their marketing campaigns if they are to compete with cheaper, well-established foreign producers and still remain economically viable.

#### *Role of Public and Private Sector Research*

Research and development of the poultry and catfish industries, both at the public and private level, played a major role in their growth and evolution. Federal, state, local, and university research provided a strong foundation of baseline knowledge for both industries from the outset. Outreach and extension programs then helped disseminate this critical information down to producers at the farm level. With this critical knowledge in hand, the private sector was able to expand and improve production technologies and techniques. In the case of the broiler industry, as production expanded and the industry became more vertically integrated, large-scale private sector research and development emerged. Major companies, such as Tyson Foods, undertook research and development at the company level and provided information to farmers through various programs and arrangements.

In the catfish industry, extension programs played a major role in technological developments. In some cases, initial technologies were developed on farms through partnerships with universities and federal research laboratories, while in other cases the technologies were primarily developed at universities and transferred through extension programs to the private sector (Engle, 2005). In addition to a publicly-financed research program, there has also been some private sector funding of research. For example, Goldquist financed a selective breeding program for channel catfish. However, since the majority of catfish farms are small businesses, they do not have the capital resources necessary to fund private sector investment in research (Engle, 2005).

Applied research, both at the public and private level, will be critical to the success and viability of the U.S. offshore aquaculture industry. While current knowledge exists, further research and development is essential in this ever-changing and evolving industry. Important issues pertaining to disease management, optimal feeding and nutrition, and optimal stocking density will require further research. Both public and private sector investment in research and development will be fundamental to advancing the industry. The presence of well-defined

property rights will provide the correct economic incentives to engage in such behavior. Yet, while technological advancements and economically efficient improvements will be essential in fostering development of an offshore industry, one final key component—the participation of state, local and federal agencies—is critical.

### *Role of Government*

The establishment of land-based operations, whether it is for poultry or catfish, faces significantly fewer obstacles than the establishment of an offshore operation. This relates back to the presence of well-defined property rights in the agriculture sector. For offshore aquaculture, the establishment of zoning and permitting will be critical in the creation of these rights.

As a first step, the government needs to establish a streamlined process for identifying approved areas for offshore aquaculture operations. The zoning process should consider such factors as potential interactions with existing users (commercial, recreations, shipping) and potential interactions with marine life (mammalian interactions and impacts on the surrounding marine environment), as well as bio-geochemical considerations (temperature, nutrients, upwelling, currents, etc.). It is the role of the government to parse out where offshore activity is permitted, leaving the operator free to choose when and how he or she will operate within those zones. Relating back to the U.S. broiler and catfish industries, each was able to operate with minimal restrictions or complications from outside influences. Certainly farmers had to comply with environmental guidelines and requirements (rules regarding waste disposal and groundwater contamination, etcetera) but there was little else constraining their investment and production decisions. Similarly, the government needs to establish where activity is permitted and then allow operators to manage their operations, much like their agricultural counterparts.

Once zoning rules and regulations are established, the actual process of issuing permits to prospective operators must be streamlined. Currently, a number of permits must be obtained for an aquaculture operation—many of which must be obtained in a specific, sequential order. Delay in a given permit can de-rail the entire permitting process, as granted permits expire before other permits are obtained. Additionally, the permitting process is costly—both in terms of the time spent throughout the duration of the permitting process and also in legal fees incurred to fight challenges and denials.

The National Offshore Aquaculture Act of 2007, proposed by NOAA, is designed to streamline the permitting process for offshore aquaculture operations. It is a first step in establishing well-defined property rights for operators, while also addressing the need for regulatory guidelines to address potential environmental impacts and interactions. This Act will be critical to the establishment of an offshore aquaculture sector in the U.S. If current zoning and permitting ambiguities persist, offshore aquaculture will seek out less risky and more business-friendly countries. As it stands, over 80% of the seafood consumed within the U.S. is imported and at least 40% of that is farm-raised (NMFS, 2007, USDA/FAS, 2005). Furthermore, the U.S. seafood trade deficit reached an all-time record of \$9.2 billion in 2006, and that number will only grow as the demand for seafood products continues to expand and domestic production remains constant (NMFS, 2007).

## Conclusion

To recap, a key component in the establishment of any industry is the establishment of well-defined property rights. Well-defined property rights provide appropriate economic incentives for owners to engage in long-term planning and investments that foster a more efficient use of the resource. In the case of a U.S. offshore aquaculture industry, zoning and permitting issues have hindered industry development. This, in turn, has hindered ancillary developments, such as the ability to secure capital for financing, investment in research and development, and growth and emergence of complementary industries. The development of transportation networks, processing facilities, feed, and hatchery facilities all must occur in a coordinated fashion. The failure of property rights in one industry will affect other industries, given the interdependent nature of aquaculture production. Efforts are already underway to streamline the permitting process with the presentation of the National Offshore Aquaculture Act of 2007 to Congress. The U.S. government has the ability to advance the development of an offshore industry in the United States, and the National Offshore Aquaculture Act of 2007 represents an important first step in this endeavor.

## References

- Anderson, J.L. 2003. *International Seafood Trade*. Woodhead Publishing Ltd., Cambridge, England.
- Anderson, James L. 2002. Aquaculture and the Future: Why Fisheries Economists should Care. *Marine Resource Economics* 17:133-152.
- Baskaran, R. and J. L. Anderson. 2004. Atlantic Sea Scallop Management: An Alternative Rights-based Cooperative Approach to Resource Sustainability. *Marine Policy* 29:357-369.
- Bell, D. 2005. Personal communication.
- Bell, D. and W. Weaver (eds.) 2002. *Commercial Chicken Meat and Egg Production*. Fifth Edition. Kluwer Academic Publishers. Massachusetts.
- Bennett, D. 2003. Low prices, imports slow catfish industry. Delta Farm Press. [http://deltafarmpress.com/mag/farming\\_low\\_prices\\_imports/](http://deltafarmpress.com/mag/farming_low_prices_imports/)
- Coblentz, B. 2005. Catfish market prices up and feed prices down. Delta Farm Press. [http://deltafarmpress.com/mag/farming\\_catfish\\_market\\_prices/index.html](http://deltafarmpress.com/mag/farming_catfish_market_prices/index.html)
- Cochran, Thad. 2004. Industry Overview. National Warmwater Aquaculture Center. [http://msstate.edu/dept/tcnwac/industry\\_overview1.htm](http://msstate.edu/dept/tcnwac/industry_overview1.htm)
- Cunningham, Dan. 2005. Contract Broiler Production: Questions and Answers. L-423 Cooperative Extension Service. University of Georgia, College of Agricultural and Environmental Sciences.

Cunningham, Dan. 2002. Guide for Prospective Contract Broiler Producers. Bulletin 1167. Cooperative Extension Service. University of Georgia, College of Agricultural and Environmental Sciences.

Dean, S., T. Hanson, and S. Murray. 2003. Economic Impact of the Mississippi Farm-Raised Catfish Industry at the year 2003. Mississippi State University Extension Service. Publication No. 2317.

Engle, C. and K. Quagraine. 2006. The Aquaculture Marketing Handbook. Iowa State Press. Ames, Iowa.

Engle, C. 2005. Species Specific Public Policy for Sustainable Development: The US Catfish Industry. Presentation: Workshop on socioeconomic aspects of Species and System Selection for Sustainable Aquaculture. East-West Center, Honolulu, HI. Oct. 17-20.

Engle, C. 2003. The evolution of farm management, production efficiencies, and current challenges to catfish production in the United States. *Aquaculture Economics and Management* 7(1/2).

FAO (Food and Agricultural Organization). 2005. FishStat Plus: Universal Software for Fishery Statistical Time Series.

Forster, John. 1999. Aquaculture Chickens: Salmon - A Case Study. *World Aquaculture* 30(3):33-40.

Guttormsen, A.G. 2002. Input Substitutability in Salmon Aquaculture. *Marine Resource Economics* 17:91-102.

Hargreaves, John. 2002. Channel Catfish Farming in Ponds: Lessons from a Maturing Industry. *Reviews in Fisheries Science* 10(3-4): 499-528.

Kinnucan, H.W. 1995. Catfish Aquaculture in the United States: five propositions about industry growth and policy. *World Aquaculture* 26(1):13-20.

Klinkhardt, M. 2004. Fish INFOnetwork Market Report on Basa, provided by Eurofish, February 2004.

Lewis, G. and J. Shelton. Channel Catfish Production. Aquaculture Technical Series. Cooperative Extension Service. Edited by Lewis, G. and R. Gilbert. University of Georgia College of Agricultural and Environmental Sciences.

Mississippi State University Extension Service. 2004. Aquaculture: Catfish. <http://msucares.com/aquaculture/catfish/>

National Chicken Council (NCC). 2005. <http://www.nationalchickencouncil.com/aboutNCC/>

National Fisheries Institute (NFI). 2005. Top Ten Seafood Rankings provided by Howard Johnson, H.M. Johnson & Associates for NFI. <http://www.aboutseafood.com>

National Marine Fisheries Service (NMFS). 2007. *Fisheries of the United States 2006*. U.S. Department of Commerce, National Oceanic and Atmospheric Administration, National Marine Fisheries Service, Office of Science and Technology, Fisheries Statistics Division. July 2007.

Swick, R.A. & Cremer, M.C. 2001. "Livestock production: a model for aquaculture?" Guest Lecture. In R.P. Subasinghe, P. Bueno, M.J. Phillips, C. Hough, S.E. McGladdery & J.R. Arthur, eds. *Aquaculture in the Third Millennium*. Technical Proceedings of the Conference on Aquaculture in the Third Millennium, Bangkok, Thailand, 20-25 February 2000. pp.49-60. NACA, Bangkok and FAO, Rome.

Tacon, A.G. 2005. State of Information on Salmon Aquaculture Feed and the Environment. [http://www.westcoastaquatic.ca/Aquaculture\\_feed\\_environment.pdf](http://www.westcoastaquatic.ca/Aquaculture_feed_environment.pdf)

Tucker, C., J. Avery, C. Engle, and A. Goodwin. 2004. "Industry Profile: Pond-Raised Channel Catfish." A review developed for the National Risk Management Feasibility Program for Aquaculture. Department of Agricultural Economics, Mississippi State University.

USDA APHIS. 2001. "Highly Pathogenic Avian Influenza: A Threat to U.S. Poultry." Program Aid No. 1704. [http://www.aphis.usda.gov/lpa/pubs/pub\\_ahhpai.pdf](http://www.aphis.usda.gov/lpa/pubs/pub_ahhpai.pdf)

USDA ERS. 2005. Briefing: Poultry and Eggs. <http://www.ers.usda.gov/Briefing/Poultry/>

USDA ERS. 2004a. Per Capita consumption data, <http://www.ers.usda.gov/data/foodconsumption/FoodAvailSpreadsheets.htm>

USDA ERS 2004b. Poultry Yearbook (89007) Tables 87 and 88. <http://usda.mannlib.cornell.edu/data-sets/livestock/89007/>

USDA FAS 2005. International Trade Report. July 8, 2005. [http://www.fas.usda.gov/ffpd/Fish-Circular/Market\\_News/IATR\\_Seafood\\_Imports.pdf](http://www.fas.usda.gov/ffpd/Fish-Circular/Market_News/IATR_Seafood_Imports.pdf)

USDA NASS. Various Years. Catfish Processing. <http://usda.mannlib.cornell.edu/reports/nassr/other/pcf-bb/>

USDA NASS. 2005a. Trends in U.S. Agriculture. <http://www.usda.gov/nass/pubs/trends/broiler.htm>

USDA NASS 2003. Aquaculture Situation and Outlook Report. <http://usda.mannlib.cornell.edu/reports/erssor/livestock/ldp-aqs/2003/aqs18.pdf>

USDA NASS. 2002. US Broiler Industry Structure. <http://usda.mannlib.cornell.edu/reports/nassr/poultry/industry-structure/specpo02.pdf>



United States International Trade Commission (USITC). 2003. Certain Frozen Fish Fillets from Vietnam. Investigation No. 731-TA-1012 (Final). Publication 3617. August 2003.  
[http://hotdocs.usitc.gov/docs/pubs/701\\_731/pub3617.pdf](http://hotdocs.usitc.gov/docs/pubs/701_731/pub3617.pdf)

US Poultry & Egg Association. 2005. [http://www.poultryegg.org/economic\\_data/](http://www.poultryegg.org/economic_data/)

Watts, G. and C. Kennett. 1995. The broiler industry. Poultry Tribune, Centennial Edition. Watt Publishing. p. 6-18.

World Health Organization (WHO). 2004. Avian influenza – fact sheet.  
[http://www.who.int/mediacentre/factsheets/avian\\_influenza/en/index.html](http://www.who.int/mediacentre/factsheets/avian_influenza/en/index.html)

*This page intentionally left blank.*

# CHAPTER 6

## Economic Models of Potential U.S. Offshore Aquaculture Operations

Di Jin

---

*This chapter provides a quantitative assessment of the economic feasibility of offshore aquaculture using a bio-economic model of firm-level investment and production.*

### Introduction

To evaluate the economic potential of offshore aquaculture, interactions among various economic and biological factors in a specific production process (species, technology, and location, for example) are modeled. Typically, a firm-level investment-production model includes revenue from fish sales, different cost components, and a biological growth function. The total cost of a specific technology consists of fixed and variable components. Fixed cost (for example, construction cost) is “sunk cost” once an investment has been made. Variable cost (such as feed, energy, and labor) may be controlled in future operations. Production may be optimized to improve the economic efficiency of a specific system.<sup>1</sup> Suppose revenue and cost projections for an open-ocean aquaculture project are accurate and there are no risks. A firm’s investment decisions can be made according to the traditional NPV (net present value) rule: invest when the value of the project is at least as large as the investment costs ( $NPV \geq 0$ ).

This chapter provides a quantitative assessment of the economic feasibility of offshore aquaculture using a bio-economic model of firm-level investment and production. We develop case studies of offshore productions of Atlantic cod and salmon, respectively. The production technologies examined are large, offshore cage farms with a high level of automation.<sup>2</sup>

### The Model

Our model assumes that the offshore grow-out operation will produce a fixed amount of fish each month, following pre-determined stocking and harvesting schedules.<sup>3</sup> The model simulates fish growth and projects financial flows for each month in a 15-year period. It calculates project NPV, the amount of up front investment required, and different cost components.

The model may take into account seasonal variability in the price of fish landings as well as the effect of water temperature on fish growth rates. It allows for comparison of different species at alternate grow-out sites, based on their biological and physical characteristics (Kite-Powell et al., 2003). Several economic, biological, and environmental variables (such as price, mortality, and water temperature) may be specified as stochastic to

---

<sup>1</sup> For example, the biomass growth rate may be controlled through feeding rate and changes in density (e.g., stocking rate, survival/culling) (see Allen et al., 1984; Arnason, 1992).

<sup>2</sup> For an introduction to cage aquaculture, see Beveridge (2004).

<sup>3</sup> A different version of the model allows the optimization over stocking time and number of fish for each harvest month (see Kite-Powell et al. 2003).

capture random effects in fish growth and revenue from sales. For a given set of stochastic variables, the model calculates both the mean and the variance of project NPV.

### Fish Growth

To ensure year-round fish yield, a certain number of fingerlings are stocked each month. For a particular cohort, fish growth may be modeled using the Beverton-Holt approach (Ricker, 1975), as follows:

$$x(\tau) = n(\tau)w(\tau) \quad (1)$$

where  $n$  is the number of fish in thousands and  $w$  is the weight of a fish in grams. In discrete time ( $\tau = \text{month}$ ) and without intervention,

$$n(\tau) = n(\tau - 1)(1 - m) \quad (2)$$

where  $m$  is the mortality rate (Allen et al., 1984), the number of fish will decrease while weight grows.

The growth rate of individual fish weight ( $w$ ) in discrete time is

$$w(\tau) = w(\tau - 1) + g(\tau - 1) \quad (3)$$

where  $g$  is the weight growth function of an individual fish.

The feed conversion ratio (FCR) is defined as:

$$s(\tau) = \frac{f_0(\tau)}{g(\tau)} \quad (4)$$

where  $s$  is the FCR and  $f_0$  is the quantity of feed per fish. Thus, the total feed quantity in kilograms (kg) at  $\tau$  is

$$f(\tau) = f_0(\tau)n(\tau) = s(\tau)g(\tau)n(\tau) \quad (5)$$

### Revenue from Fish Sales

For specific stocking and harvesting schedules, the model calculates the financial performance of the grow-out operation month by month over 15 years to determine projected cash flows. For an individual aquaculture farm, price is exogenous. We model dockside price as a function of fish size and time of year. With total harvest fish biomass at harvest time  $x(T)$  in kg and market price ( $p$ ) in \$/kg, the gross revenue from the sale of a cohort is

$$R(t) = p[w(T), t]x(T) \quad (6)$$

where  $t$  equals time over the study period [ $t = 1, 2, \dots, 180$  (month)].<sup>4</sup>

### Costs of Investment and Production

Total cost includes expenditures on cages, a boat, fingerlings, feed, and shore-based operations (e.g., administration and marketing). In the model, we assume a sequential cage installation schedule. For cod and salmon, the grow-out period is two years. There are 24 cohorts. Thus, for each of the first 24 months, there is one new cage added to the farm. The investment cost of each cage is

$$c_k(t) = v(acq + inst) + efix \quad t = 1, 2, \dots, 24 \quad (7)$$

<sup>4</sup> In the model, we specify stocking and harvesting schedules within this time frame. For example, Cohorts 1 is initially stocked at  $t = 1$  ( $\tau = 1$ ), harvested at  $t = 24$  ( $\tau = T$ ), and re-stocked at  $t = 25$  ( $\tau = 1$ ). Note that  $R(t) = 0$  for  $t = 1 - 23$ .

where  $c_k$  is the cost of each cage in \$,  $v$  is the cage volume in  $m^3$ ,  $acq$  is the cage acquisition cost in  $\$/m^3$ ,  $inst$  is the cage mooring and installation cost in  $\$/m^3$ , and  $efix$  is the fixed cost associated with environmental compliance in  $\$/cage$ .

The installation cost is a function of water depth in meters ( $wd$ ):

$$inst = 2 + 0.02wd \quad (8)$$

For cage maintenance in subsequent months, the maintenance cost is

$$c_m(t) = v \cdot cn(t) \cdot cm(t) / 12 + evar(t) \quad t = 25, 26, \dots, 180 \quad (9)$$

where  $cn$  is the number of cages in the farm,  $cm$  is the cage operating and maintenance cost in  $\$/m^3/year$ , and  $evar$  is the variable cost of environmental compliance in  $\$/month$ .

Each month, feed and fingerlings are transported to the farm and harvest is transported back to shore by boat. Aggregating cage-level feed quantity [ $f(\tau)$  from (5)], we have the farm-level monthly feed quantity ( $fq$ ) in kg:

$$fq(t) = \sum_{\tau=1}^{cn(t)} f(\tau) \quad (10)$$

For each month, the quantity of fingerling and water transported for stocking ( $sq$ ) in kg is

$$sq(t) = stock \cdot sg \cdot \varphi \quad (11)$$

where  $stock [= n(0)]$  is the number of fingerlings in thousands,  $sg$  is the fingerling weight in gram/fish, and  $\varphi$  is the ratio of water weight to fingerling weight during transport to farm.

For each month, the total number of round trips is calculated as either the number of trips necessary for transporting harvest from the farm or the number of trips needed for transporting feed and fingerlings to the farm, whichever is greater.

$$nr(t) = \max\{x(T) / ld, [fq(t) + sq(t)] / ld\} \quad (12)$$

where  $x(T)$  is the fish harvest in kg,  $ld$  is the boat payload in kg,  $fq$  is the feed quantity in kg,  $sq$  is the quantity of fingerlings in kg;  $nr$  is rounded to the nearest greater integer.

Since one vessel can transport a larger volume of cargoes by making more trips in a day if the distance to shore is short, the number of vessels needed for a given cargo volume is affected by distance. To estimate the number of vessels needed for the cargo volume, we first estimate the time for a round-trip ( $h$ ):

$$h = 2d / spd + z_l + z_u \quad (13)$$

where  $d$  is the distance and  $spd$  is the average speed of the vessel in km per hour. The round-trip time is extended by adding the time for loading ( $z_l$ ) and unloading ( $z_u$ ).

The number of trips a vessel can make in a day is estimated as

$$nd = h_m / h \quad (14)$$

where  $h_m$  is the number of hours per day the boat is operational;  $nd$  is rounded to the nearest lower integer. The number of trips a vessel can make in a month is

$$nm = d_m \cdot nd \quad (15)$$

where  $d_m$  is the number of days per month the boat is operational. Thus, the number of vessels required for a specific month is:

$$bn(t) = nr(t) / nm \quad (16)$$

where  $nr(t)$  and  $nm$  are defined in (12) and (15), respectively;  $bn$  is rounded to the nearest greater integer.

The total number of boat days in a month is:

$$bd(t) = nr(t) / nd \quad (17)$$

$bd$  is rounded to the nearest greater integer.

For each month, boat cost ( $c_b$ ) is

$$c_b(t) = bn(t) \cdot bfix / 12 + bvar \cdot bd(t) \quad (18)$$

where  $bfix$  is the vessel fixed cost in \$/year, and  $bvar$  is the variable and crew cost in \$/day.

Fingerling cost ( $c_r$ ) is

$$c_r(t) = 1000 \cdot stock \cdot sp \quad (19)$$

where  $sp$  is the fingerling cost in \$/fish. Feed cost ( $c_f$ ) is

$$c_f(t) = fq(t) \cdot fp \quad (20)$$

where  $fp$  is the feed cost in \$/kg. Shore cost ( $c_s$ ) is

$$c_s(t) = (sh + ins) / 12 \quad (21)$$

where  $sh$  is the on-shore cost (e.g., dock, facilities, management administration, marketing and distribution) in \$/year and  $ins$  is the insurance cost in \$/year.

From Equations (7), (9), and (18) through (21), we can calculate the total cost ( $C$ ) in each month

$$C(t) = \sum_i c_i(t) \quad (22)$$

Note that  $i = [k, m, b, r, f, s]$ .

### Net Revenue

As noted, our model simulates monthly cash flow for a 15-year period and  $t = 1, 2, \dots, 180$  (month). The cages are installed sequentially in the first 24 months. From (7), we define the present value of total investment as:

$$I = \sum_{t=1}^{24} \frac{c_k(t)}{(1 + \delta/12)^t} \quad (23)$$

where  $\delta$  is the annual discount rate (monthly discount rate is  $\delta/12$ ). The project's net present value may be computed using (6) and (22) as:

$$NPV = \sum_{t=1}^{180} \frac{R(t) - C(t)}{(1 + \delta/12)^t} \quad (24)$$

### **Model Input Parameters**

We apply the model described above to Atlantic cod and salmon, respectively. Cod can be stocked and harvested year round in southern New England waters. The grow-out site is located 6 km from the shore station or dock used by the support vessel. The water depth is 50 meters (m). Monthly water temperatures are shown in Table 6.1. Also included in Table

6.1 are the monthly average dockside prices for cod. These prices are based primarily on landed value reported by NOAA Fisheries. Biological data for the analysis are from Jobling (1988), Best (1995), and Bjorndal (1990). For specific functional forms, we model mortality in (2) as a function of fish weight ( $w$ ):

$$m(\tau) = 0.01 - 0.000001w(\tau) \quad (25)$$

The above specification is based on experience with salmon farms as reported in Bjorndal (1990).<sup>5</sup> According to Jobling (1988), the monthly growth in (3) is as a function of fish weight and water temperature:

$$g(\tau) = 0.37223w(\tau)^{0.559} e^{0.297\gamma - 0.000538\gamma^3} \quad (26)$$

where  $g$  is in grams per month,  $w$  is weight in grams, and  $\gamma$  is the temperature in degree Celsius.

Following Jobling (1988) and Best (1995), we specify FCR as a function of fish weight:

$$s(\tau) = [1.5 - 0.00035w(\tau)] / \psi \quad (27)$$

where  $0.4 \leq \psi \leq 1.1$  is an adjustment factor that allows us to change the baseline FCR ( $\psi = 1$ ) to simulate different feeding technologies.

Table 6.2 summarizes other model input parameters for cod describing the cage system, stocking, feed cost, boat, etc. These data are based on personal communications with cage manufacturers, industry experts, and Bjorndal (1990). As shown in the table, the cage capacity per cohort is 5,000 m<sup>3</sup>. With a total of 24 cohorts and annual output of over 2,000 metric tons (mt), our simulated cage farm is larger than typical existing farms.<sup>6</sup> The baseline fixed cost for the grow-out support vessel, which stocks the cages, carries feed to the cages, supports maintenance, and carries out harvesting, is \$100,000/year. Operating costs are \$1,500 a day for fuel and other consumables, and personnel costs for a crew of four are another \$1,500 per day. The vessel has an operating speed of 15 km/h and a payload capacity of 30 metric tons. On a typical round-trip carrying feed, it spends three hours on site. The maximum length of a work day is 14 hours and, due to weather constraints and maintenance requirements, the vessel is at sea a maximum of 25 days per month. On-shore costs include \$30,000/year for dock use and other on-shore facilities, \$70,000/year for management and administrative costs, and \$50,000/year for marketing and distribution. The on-shore costs cover the salaries for one manager and two office staff. A set of high-end input values<sup>7</sup> is included in the last column for sensitivity analysis. According to Tveteras (2002a), production costs decline with respect to the industry scale in a regional operation (i.e., total employment, farm density, and output quantity).

<sup>5</sup> In the study, salmon parameters are used where cod data are unavailable. It should be noted that the parameters for cod may be quite different from those for salmon.

<sup>6</sup> Existing studies have examined offshore farms with output ranging from 250 to 500 MT/year (Kam et al., 2003; Tveteras, 2002a; Posadas and Bridger, 2003; Bjorndal, 1990). The average output of 568 salmon farms in Norway was 277 mt/year (Tveteras, 2002a).

<sup>7</sup> Unit cage costs of \$27/m<sup>3</sup> and \$50/m<sup>3</sup> have been reported by Kam et al. (2003) and Posadas and Bridger (2003), respectively, for cages size below 3,000 m<sup>3</sup>. Labor cost may vary depending on both productivity (ranging from 30 to 500 MT fish per man-year) and wages (\$30 – \$60/man-year). For an assessment of labor productivity, see Forster (1999).

Environmental compliance costs are also included in the high-end cost inputs (see Table 6.2). These cost data are based on EPA (USEPA, 2002) estimates of four pollution control measures for offshore cage aquaculture: (i) Feed Management ( $fmv$  is the cost associated with extra time for record keeping); (ii) Solid Control BMP Plan ( $scf$  covers the cost associated with developing three 5-year plans, and  $scv$  is the cost for monthly review of the plans); (iii) Drug and Chemical Control BMP Plan ( $dcf$  is the cost to develop three 5-year plans, and  $dcv$  is the cost for monthly review of the plans); and (iv) Active Feed Monitoring ( $aff$  is the cost of one set of underwater cameras and  $afv$  is the cost associated with feeding control). These pollution control measures are cumulative and designed to lower feed and drug inputs. Note that  $efix$  in (7) is calculated using  $scf$ ,  $dcf$ , and  $aff$ , and  $evar$  in (9) is based on  $fmv$ ,  $scv$ ,  $dcv$ , and  $afv$ .

For salmon, we consider the same production schedule and similar technology. Monthly growth is modeled as:

$$g(\tau) = 141 + 0.024w(\tau) \quad (28)$$

The FCR is:

$$s(\tau) = 1.5 - 0.00011w(\tau) \quad (29)$$

We specify a salmon price of \$4/kg for base case simulation. Other baseline and high-end input parameters are summarized in Table 6.3. Note that the number of juvenile salmon stocked in each cohort is much smaller (45,000) than that of cod (150,000 in Table 6.2), as the size of juvenile salmon is large and also more costly.

## Simulations and Results

Using the input parameters in Tables 6.1 and 6.2, we use the model<sup>8</sup> to simulate offshore cod production. For the baseline input parameters, an open-ocean cod farm requires an investment of \$2.01 million to construct and the project's net present value (NPV) is \$10.62 million (Table 6.4). Once fully installed, the farm produces cod year-round with an average production rate of 177 metric tons per month. Using the monthly farm-level feed quantity ( $fq$ ) from (10) we estimate the average yearly feed quantity as 2,765 metric tons per year. The present value of total project cost in 15 years<sup>9</sup> is \$35.87 million, or \$2.39 million per year. The largest cost components are feed (41%) and fingerlings (40%). For the set of high-end costs (last column in Table 6.2), the offshore project is not economically feasible (NPV = -\$13.38 million < 0). Using baseline costs, we calculate the NPV for different prices. As depicted in Figure 6.1, offshore cod farming is not economically feasible if the price is below \$2/kg.

The simulation results for salmon are presented in Table 6.5. For the baseline input parameters in Tables 6.3 and at a harvest price of \$4/kg, an offshore salmon farm generates a NPV of \$29.49 million. The farm produces salmon year round with an average production

<sup>8</sup> All computer programs for the study are written in MATLAB.

<sup>9</sup> Including both investment and operating costs.



rate of 169 metric tons per month.<sup>10</sup> The average yearly feed quantity is 2,619 metric tons per year. The 15-year total project cost is \$31.32 million (\$2.09 million per year). As for cod production, the largest cost components are feed (55%) and fingerlings (24%). For high-end costs, the project NPV is reduced to \$14.29 million. Again, we conduct a sensitivity analysis with respect to fish price, using baseline costs. The results indicate that offshore salmon farming is also not economically feasible if the price is below \$2/kg (see Figure 6.2).

Given the importance of feed cost in offshore production, we examine the effect of different feed conversion ratios (FCR) on feed quantity and, in turn, on NPV for cod farming (see Figure 6.3).<sup>11</sup> As shown in the upper panel of the figure, cod aquaculture is economically feasible (NPV > 0) when average FCR is below 2.3. Efforts have been made by the aquaculture industry to lower FCR. For example, in the Norwegian salmon industry, FCR declined from close to 3 in 1980 to just over 1 in 2000 (Tveteras, 2002b). In lab experiments, it has been possible to achieve FCRs as low as 0.6 (Asche et al., 1999).<sup>12</sup>

Next, using the baseline input parameters for cod, we simulate the impact of rising feed cost on NPV. The results are illustrated in Figure 6.4. Also shown in the figure is the effect of a discount rate on NPV. As the feed cost approaches \$1/kg, NPVs drop into the neighborhood of zero. As expected, for a fixed feed cost, NPV declines with a higher discount rate.

As noted, several key economic and biological variables in the model may be specified as stochastic. In this example, we attach a normally distributed random element,  $\xi_j \sim N(0, \sigma_j^2)$ , to each of the five variables: mortality rate ( $m$ ), water temperature ( $\gamma$ ), fish weight growth ( $g$ ), fish price ( $p$ ), and feed cost ( $fp$ ). We run the stochastic version of the baseline cod model for two sets of variances, as Cases 1 and 2 shown in Table 6.6. For Case 1, the expected NPV is \$10.81 million and the variance of project NPV is 6.37. For Case 2, the expected NPV is \$11.83 million with a much larger variance of 33.88. The histograms of the random error terms attached to each of the five variables and resulting NPVs for Cases 1 and 2 are depicted in Figures 6.5 and 6.6, respectively. The figures show that for the set of smaller variances (Case 1), the NPV is always positive, while for the set of larger variances (Case 2), the left-side tail of the distribution clearly suggests the possibility of negative net returns.

When risk and uncertainty are present, the basic investment rule should be modified. Generally, a greater revenue stream will be required to justify the same level of investment. Although individuals have different attitudes toward risk, most are either risk neutral or slightly risk averse (see Kumbhakar, 2002; Eggert and Martinsson, 2004). For risk-averse investors, the investment rule is to invest if the value of the project is at least as large as the investment cost plus a risk premium.<sup>13</sup>

<sup>10</sup> Year-round stocking for salmon production may not be feasible in some locations (see Kite-Powell et al., 2003).

<sup>11</sup> Baseline costs were used for the simulation.

<sup>12</sup> FCRs vary among species and production systems and geography.

<sup>13</sup> For a discussion of risk and aquaculture, see Jin et al. (2005).

Finally, we examine the effect of distance from dock to grow-out site (distance to shore) on the economic feasibility of offshore aquaculture. Because most of the near-shore waters are heavily used for fishing and recreation, the most promising direction for aquaculture is far offshore, in open water relatively free of use conflicts and environmental contamination. Investment and production costs escalate as a cage farm is sited further offshore for two reasons. First, the cost of cage installation is proportional to water depth (Equation 8). In addition, vessel transportation costs are also positively related to distance. Two water depth profiles near Cape Cod are depicted in Figure 6.7. Apparently, growth in costs with respect to distance is greater to the north than to the south of Cape Cod, as water depth increases more rapidly in the north.

Again, we use the baseline cod model to illustrate how distance to shore affects boat operation and related costs.<sup>14</sup> In the study, we consider only vessel day trips and set the maximum distance at 25 nautical miles (46.3 km). A further increase in distance may significantly alter vessel operations and result in substantial cost escalations.

As shown in the upper section of Table 6.7, one 30-ton vessel operating 14 hours a day is capable of meeting the transportation need of an offshore cage farm located within 25 nautical miles. At the 5-nautical-mile location, the vessel can make two trips a day, lowering the total number of boat days in a month and related costs. The effect of increasing distance on vessel trips is more evident when vessel operation time is extended to 20 hours a day (see the middle section in the table). The vessel trip number declines from three per day at 5 nautical miles to one per day at 25 nautical miles. As a result, the total number of boat days per month rises from 7 to 19. To highlight the effect, we reduce the vessel payload to 5 tons in our simulation.<sup>15</sup> For the smaller vessel size (lower section in the table), we see an increase in vessel numbers from two to five as the distance to shore rises from 5 to 25 nautical miles. The related effect on costs is more drastic. In all three cases, the cost share for cage installation is relatively stable, suggesting a smaller effect of distance on investment cost than operating cost.

We plot the total 15-year project costs (in Table 6.7) with respect to distance to shore in Figure 6.8. The investment and production costs are influenced by vessel operation schedules. As noted, larger vessels carry more cargo and make fewer trips than smaller vessels. Longer vessel operation hours enable more trips in a day. Thus, the case with 5-ton vessels is more costly than that with a 30-ton vessel. For the same vessel (i.e., 30-ton), the total cost is lower if the vessel operation time is extended from 14 to 20 hour per day.

## Conclusions

Open-ocean aquaculture is an emerging industry. Some technical, biological, and regulatory uncertainties surrounding open-ocean grow-out systems are now being resolved through publicly-sponsored demonstration projects and private sector start-ups. In this chapter, we develop a quantitative assessment of the economic feasibility of offshore aquaculture. The analytical framework is based on a firm-level investment-production model

<sup>14</sup> Water depth profile north of Cape Cod was used in the simulations.

<sup>15</sup> Boat costs were kept unchanged in the simulation, leading to a higher unit cost (\$/payload ton).

that simulates individual grow-out projects and estimates the project's investment, cost shares, and NPV. We develop simulations of offshore aquaculture of Atlantic cod and salmon, respectively. The simulated production technologies are large offshore cage farms with annual output over 2,000 metric tons.

Both cod and salmon farming in offshore waters are shown to be economically feasible based on our baseline cost and revenue parameters. Offshore aquaculture may not be profitable if the price of fish is below \$2/kg (\$0.91/lb), feed cost is higher than \$1/kg, or the feed conversion ratio (FCR) is greater than 2. Costs of feed and juvenile fish account for over 70% of the total investment and operating costs. In the case of salmon, the share of feed cost is about 50%.

Offshore aquaculture may only be economically feasible in waters within 25 nautical miles. Further increases in offshore distance will significantly alter the vessel operation schedule and result in a substantial cost increase. Operating under risk and uncertainty, greater project revenues are needed to justify the elevated total cost of investment (for example, a firm's risk premium).

## References

- Allen, P.G., L.W. Botsford, A.M. Schuur and W.E. Johnson. 1984. *Bioeconomics of Aquaculture*. New York: Elsevier.
- Arnason, R. 1992. Optimal feeding schedules and harvesting time in aquaculture. *Marine Resource Economics* 7(1):15-35.
- Asche, F., A.G. Guttormsen and R. Tveteras. 1999. Environmental problems, productivity and innovations in Norwegian salmon aquaculture. *Aquaculture Economics and Management* 3:19-29.
- Best, N.A. 1995. Preliminary Design of a Recirculating Aquaculture System in Boston Harbor. MS thesis, Massachusetts Institute of Technology.
- Beveridge, M. 2004. *Cage Aquaculture*, 3rd ed. Ames, IA: Blackwell Publishing.
- Bjorndal, T. 1990. *The Economics of Salmon Aquaculture*. Boston: Blackwell Scientific Publications.
- Eggert, H. and Martinsson, P. 2004. Are commercial fishers risk-lovers? *Land Economics* 80(4):550-560.
- Forster, J. 1999. Halibut Farming: Its Development and Likely Impact on the Market for Wild Alaska Halibut. Report to Alaska Department of Commerce and Economic Development. Juneau, AK.
- Jin, D., H.L. Kite-Powell and P. Hoagland. 2005. Risk assessment in open-ocean aquaculture: a firm-level investment-production model. *Aquaculture Economics and Management* 9(3):369-387.

Jobling, M. 1998. A Review of the physiological and nutritional energetics of cod, *Gadus morhua* L., with particular reference to growth under farmed conditions. *Aquaculture* 70:1-19.

Kam, L.E., P.S. Leung and A.C. Ostrowski. 2003. Economics of offshore aquaculture of Pacific threadfin (*Polydactylus sexfilis*) in Hawaii. *Aquaculture* 223:63-87.

Kite-Powell, H.L., P. Hoagland, D. Jin and K. Murray. 2003. Open ocean grow-out of finfish in New England: a bioeconomic model. In C.J. Bridger and B.A. Costa-Pierce, eds. *Open Ocean Aquaculture: From Research to Commercial Reality*. Baton Rouge, LA: The World Aquaculture Society, pp. 319-324.

Kumbhakar, S.C. 2002. Risk preferences and technology: a joint analysis. *Marine Resource Economics* 17(2):77-89.

Posadas, B.C. and C.J. Bridger. 2003. Economic feasibility of offshore aquaculture in the Gulf of Mexico. In C.J. Bridger and B.A. Costa-Pierce, eds. *Open Ocean Aquaculture: From Research to Commercial Reality*. Baton Rouge, LA: The World Aquaculture Society, pp. 307-317.

Ricker, W.E. 1975. *Computation and Interpretation of Biological Statistics of Fish Populations*. Ottawa, ON: Canada Department of the Environment, Fisheries and Marine Service, *Bull. Fish. Res. Board Can.* 191.

Tveteras, R. 2002a. Industrial agglomeration and production costs in Norwegian salmon aquaculture. *Marine Resource Economics* 17:1-22.

Tveteras, S. 2002b. Norwegian salmon aquaculture and sustainability: the relationship between environmental quality and industrial growth. *Marine Resource Economics* 17:121-132.

U.S. Environmental Protection Agency (USEPA), Office of Water. 2002. *Development Document for Proposed Effluent Limitations Guidelines and Standards for the Concentrated Aquatic Animal Production Industry Point Source Category*. EPA-821-R-02-016, August. Washington, DC.

**Table 6.1. Monthly average temperatures and cod price by size.**

Month	Water Temperature	Cod Price (\$/kg)		
	C <sup>0</sup>	Small	Medium	Large
Jan	2	2.70	3.14	3.57
Feb	2	2.64	3.14	3.48
Mar	3	2.59	3.09	3.43
Apr	5	2.21	2.63	2.91
May	10	2.31	2.75	3.05
Jun	17	2.31	2.75	3.05
Jul	21	2.23	2.65	2.94
Aug	22	2.55	3.04	3.37
Sept	22	2.49	2.96	3.29
Oct	18	2.54	3.03	3.36
Nov	10	2.33	2.78	3.08
Dec	5	2.60	3.10	3.44

*Note:* Cod size categories are: small (750 grams  $\leq w < 1,130$  grams); medium (1,130 grams  $\leq w < 2,270$  grams); and large ( $w \geq 2270$  grams). For  $w < 750$  grams, the assumed price is zero.

**Table 6.2. Model input parameters: cod.**

Parameter	Description	Unit	Baseline Value	High-end Value
<i>v</i>	cage volume per cohort	m <sup>3</sup>	5,000	5,000
<i>acq</i>	cage purchase cost <sup>a</sup>	\$/m <sup>3</sup>	15.00	25
<i>inst</i>	cage mooring and installation cost	\$/m <sup>3</sup>	3.00	3.00
<i>cm</i>	cage operating and maintenance cost <sup>b</sup>	\$/m <sup>3</sup> /year	1.00	6
<i>stock</i>	number of fingerlings stocked per cohort	1,000 fish	150	150
<i>sg</i>	stocking weight	gram/fish	50	50
$\varphi$	ratio of water weight to fingerling weight during transport to farm		5	5
<i>sp</i>	fingerling cost	\$/fish	0.85	1.50
<i>fp</i>	feed cost	\$/kg	0.60	0.73
<i>bfix</i>	vessel fixed cost	\$/year	100,000	150,000
<i>bvar</i>	vessel variable and crew cost <sup>c</sup>	\$/day	3,000	3,000
<i>ld</i>	vessel payload	MT	30	30
<i>trip</i>	round trips per day		3	3
<i>sh</i>	on shore cost <sup>d</sup>	\$/year	150,000	250,000
<i>ins</i>	insurance cost <sup>e</sup>	\$/year	50,000	300,000
<i>fmv</i>	feed management variable cost	\$/cohort/month	0	33.32
<i>scf</i>	solid control BMP plan fixed cost	\$/farm	0	1615.20
<i>scv</i>	solid control BMP plan variable cost	\$/month	0	21.15
<i>dcf</i>	drug and chemical control BMP plan fixed cost	\$/farm	0	1615.20
<i>dcv</i>	drug and chemical control BMP plan variable cost	\$/month	0	21.15
<i>aff</i>	active feed monitoring fixed cost	\$/farm	0	10,000
<i>afv</i>	active feed monitoring fixed cost	\$/cohort/month	0	33.32
$\delta$	annual discount rate		0.07	0.07

*Notes:*

- a. Including feeder and other equipment
- b. Including fuel, utilities, diving, repair, etc.
- c. Including 4 crews (average \$25/hour)
- d. Including salaries for 1 manager and 2 office staff
- e. Insurance covers fish and other capital

**Table 6.3. Model input parameters: salmon.**

Parameter	Description	Unit	Baseline Value	High-end Value
<i>v</i>	cage volume per cohort	m <sup>3</sup>	5,000	5,000
<i>acq</i>	cage purchase cost	\$/m <sup>3</sup>	15.00	25
<i>inst</i>	cage mooring and installation cost <sup>a</sup>	\$/m <sup>3</sup>	3.00	3.00
<i>cm</i>	cage operating and maintenance cost <sup>b</sup>	\$/m <sup>3</sup> /year	1.00	6
<i>stock</i>	number of fingerlings stocked per cohort	1,000 fish	45	45
<i>sg</i>	stocking weight	gram/fish	150	150
$\varphi$	ratio of water weight to fingerling weight during transport to farm		5	5
<i>sp</i>	fingerling cost	\$/fish	1.50	1.75
<i>fp</i>	feed cost	\$/kg	0.73	0.9
<i>bfix</i>	vessel fixed cost	\$/year	100,000	150,000
<i>bvar</i>	vessel variable and crew cost <sup>c</sup>	\$/day	3,000	3,000
<i>ld</i>	vessel payload	MT	30	30
<i>trip</i>	round trips per day		3	3
<i>sh</i>	on shore cost <sup>d</sup>	\$/year	150,000	250,000
<i>ins</i>	insurance cost <sup>e</sup>	\$/year	50,000	300,000
<i>fmv</i>	feed management variable cost	\$/cohort/month	0	33.32
<i>scf</i>	solid control BMP plan fixed cost	\$/farm	0	1615.20
<i>scv</i>	solid control BMP plan variable cost	\$/month	0	21.15
<i>dcf</i>	drug and chemical control BMP plan fixed cost	\$/farm	0	1615.20
<i>dcv</i>	drug and chemical control BMP plan variable cost	\$/month	0	21.15
<i>aff</i>	active feed monitoring fixed cost	\$/farm	0	10,000
<i>afv</i>	active feed monitoring fixed cost	\$/cohort/month	0	33.32
$\delta$	annual discount rate		0.07	0.07

Notes:

- a. Including feeder and other equipments
- b. Including fuel, utilities, diving, repair, etc.
- c. Including 4 crews (average \$25/hour)
- d. Including salaries for 1 manager and 2 office staff
- e. Insurance covers fish and other capital

**Tables 6.4. Model results: cod.**

<b>Output Variable</b>	<b>Description</b>	<b>Unit</b>	<b>Baseline Value</b>	<b>High-end Value</b>
<i>NPV</i>	net present value	\$ million	10.620	-13.375
<i>I</i>	investment	\$ million	2.010	3.139
<i>X(T)</i>	average fish harvest	metric ton/month	177	177
<i>N(T)</i>	average number of fish harvested	fish/month	120,535	120,535
<i>W(T)</i>	average harvest fish size	kg	1.47	1.47
$12 \cdot E[fq(t)]$	average feed quantity	metric ton/year	2,765	2,765
<i>Project Cost</i>	total cost	\$ million	35.871	59.867
	average annual cost	\$ million	2.391	3.991
<i>Cost Share</i>	cage installation	%	5.6	5.2
	cage maintenance	%	2.8	10.2
	boat and crew	%	6.0	4.4
	fingerlings	%	39.5	41.8
	feed	%	40.9	29.8
	onshore and other	%	5.2	8.5
	total	%	100	100

**Tables 6.5. Model results: salmon.**

<b>Output Variable</b>	<b>Description</b>	<b>Unit</b>	<b>Baseline Value</b>	<b>High-end Value</b>
<i>NPV</i>	net present value	\$ million	29.486	14.289
<i>I</i>	investment	\$ million	2.010	3.139
<i>x(T)</i>	average fish harvest	metric ton/month	169	169
<i>n(T)</i>	average number of fish harvested	fish/month	37,446	37,446
<i>w(T)</i>	average harvest fish size	kg	4.52	4.52
$12 \cdot E[fq(t)]$	average feed quantity	metric ton/year	2,619	2,619
<i>Project Cost</i>	total cost	\$ million	31.315	46.512
	average annual cost	\$ million	2.088	3.101
<i>Cost Share</i>	cage installation	%	6.4	6.7
	cage maintenance	%	3.2	13.2
	boat and crew	%	6.0	5.0
	fingerlings	%	24.0	18.8
	feed	%	54.5	45.3
	onshore and other	%	5.9	11.0
	total	%	100	100



**Table 6.6. Stochastic variable specifications.**

<b>Variables</b>	<b>Stochastic Variables</b>	<b>Error Distributions</b>	<b>Case 1</b>	<b>Case 2</b>
mortality rate ( $m$ )	$m \exp(\xi_m)$	$\xi_m \sim N(0, \sigma_m^2)$	$\sigma_m^2 = 0.01$	$\sigma_m^2 = 0.05$
temperature ( $\gamma$ )	$\gamma + \xi_\gamma$	$\xi_\gamma \sim N(0, \sigma_\gamma^2)$	$\sigma_\gamma^2 = 0.1$	$\sigma_\gamma^2 = 0.5$
fish growth ( $g$ )	$g \exp(\xi_g)$	$\xi_g \sim N(0, \sigma_g^2)$	$\sigma_g^2 = 0.01$	$\sigma_g^2 = 0.05$
fish price ( $p$ )	$p + \xi_p$	$\xi_p \sim N(0, \sigma_p^2)$	$\sigma_p^2 = 0.1$	$\sigma_p^2 = 0.5$
feed cost ( $fp$ )	$fp + \xi_{fp}$	$\xi_{fp} \sim N(0, \sigma_{fp}^2)$	$\sigma_{fp}^2 = 0.01$	$\sigma_{fp}^2 = 0.05$

**Table 6.7. Distance to shore, vessel operations, and costs (cod) <sup>a</sup>.**

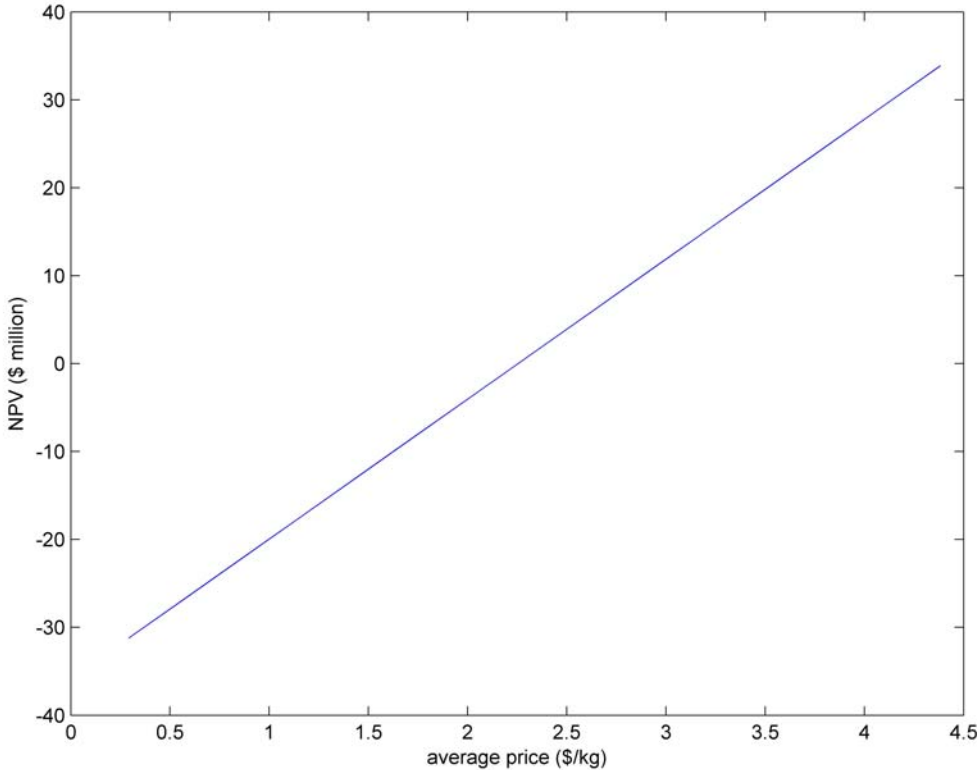
<b>Distance to shore</b> nautical miles (km)	5 (9.26)	10 (18.52)	15 (27.78)	20 (37.04)	25 (46.3)
<b>Water depth (m)</b>	22.86	45.72	76.20	106.68	152.4
<i>Vessel operation: 14 hours per day; vessel payload: 30 ton</i>					
Vessel number	1	1	1	1	1
Boat trip/day	2	1	1	1	1
Boat days/month <sup>b</sup>	10	19	19	19	19
NPV (\$ million)	10.206	8.682	8.656	8.630	8.604
Total cost (\$ million)	36.286	37.81	37.836	37.862	37.887
Cage installation (%)	5.30	5.37	5.45	5.52	5.59
Boat and crew (%)	7.32	10.99	10.98	10.98	10.97
<i>Vessel operation: 20 hours per day; vessel payload: 30 ton</i>					
Vessel number	1	1	1	1	1
Boat trip/day	3	2	2	2	1
Boat days/month <sup>b</sup>	7	10	10	10	19
NPV (\$ million)	10.706	10.180	10.155	10.129	8.604
Total cost (\$ million)	35.785	36.311	36.337	36.363	37.887
Cage installation (%)	5.38	5.45	5.52	5.59	5.66
Boat and crew (%)	6.03	7.32	7.31	7.31	10.97
<i>Vessel operation: 20 hours per day; vessel payload: 5 ton</i>					
Vessel number	2	3	3	3	5
Boat trip/day	3	2	2	2	1
Boat days/month <sup>b</sup>	38	57	57	57	114
NPV (\$ million)	5.403	2.140	2.114	2.089	-8.175
Total cost (\$ million)	41.089	44.352	44.377	44.403	54.667
Cage installation (%)	4.68	4.75	4.81	4.87	4.93
Boat and crew (%)	18.16	24.12	24.11	24.09	38.30

*Notes:*

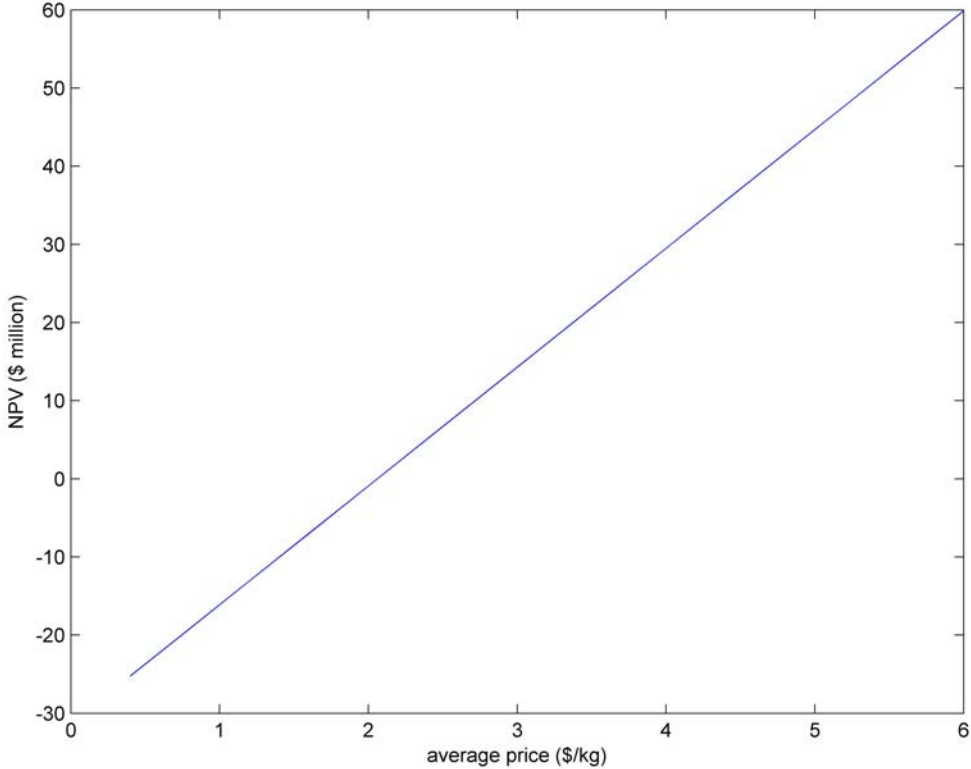
a. Loading time = 2 hours/vessel; Unloading time = 3 hours/vessel; Vessel speed = 15 km/hour; and Maximum boat days per month = 25 days

b. Total number of days of all vessels

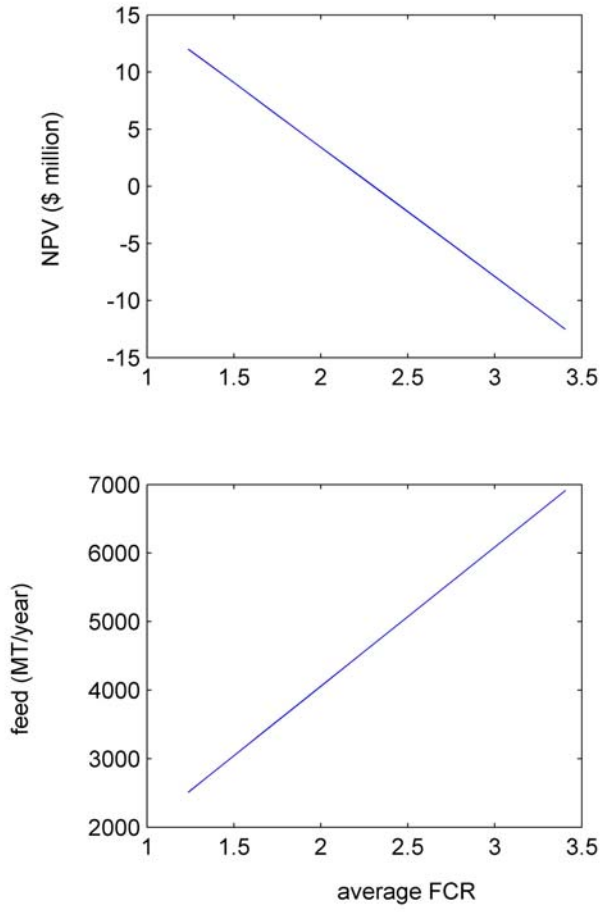
**Figure 6.1. NPV by price: cod.**



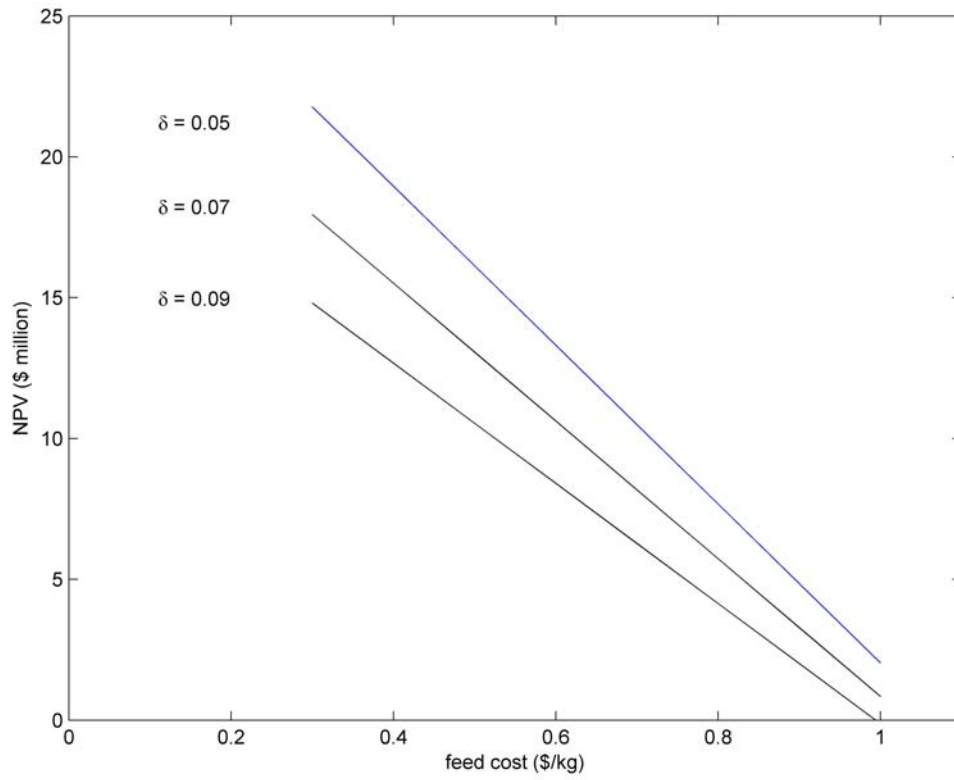
**Figure 6.2. NPV by price: salmon.**



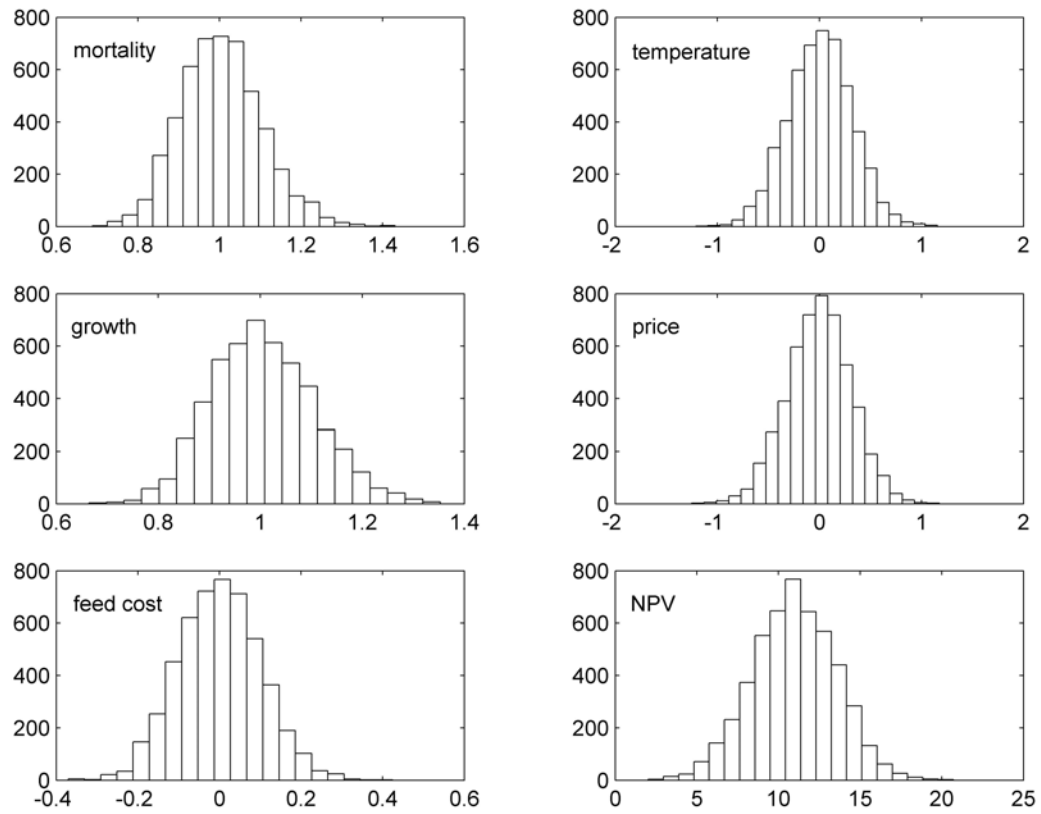
**Figure 6.3. NPV and feed quantity by FCR (cod).**



**Figure 6.4. NPV by feed cost and discount rate (cod).**

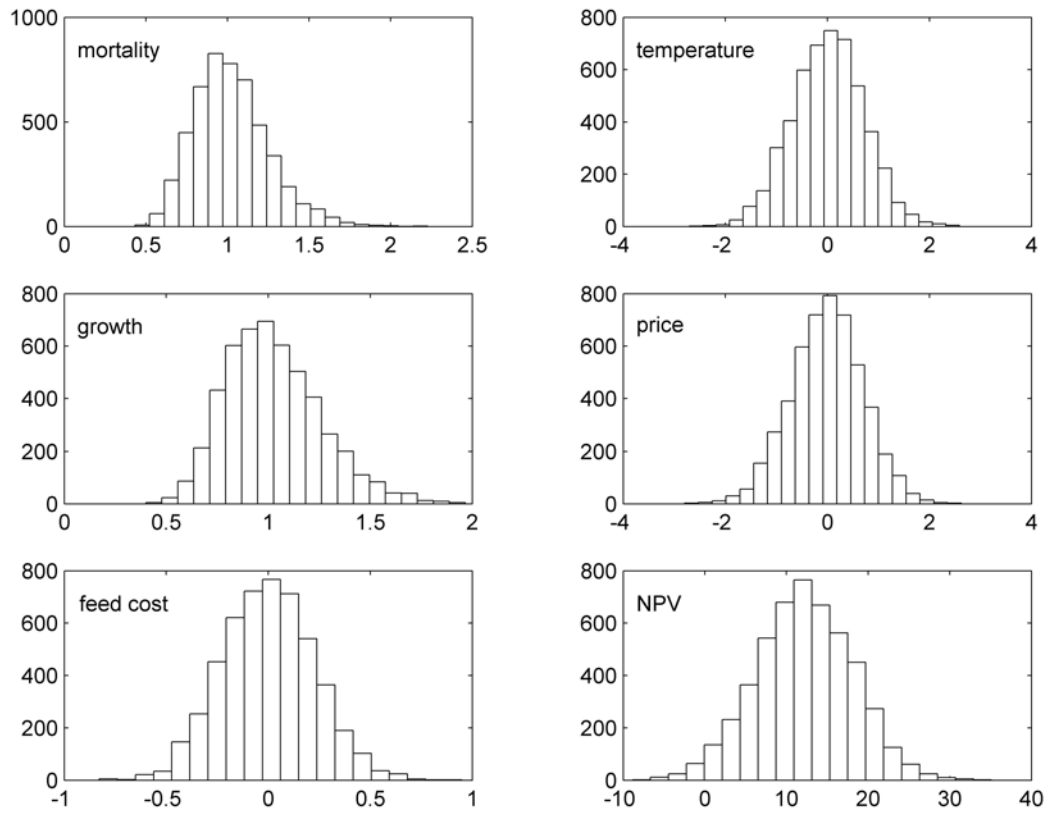


**Figure 6.5. Histograms of NPV and errors associated with key parameters (case 1).**



*Notes:* As specified in Table 6.4, the error distributions shown above are  $exp(\xi_m)$  for mortality,  $\xi_T$  for temperature,  $exp(\xi_g)$  for fish weight growth,  $\xi_p$  for fish price, and  $\xi_{fp}$  for feed cost. Number of iterations = 5,000.

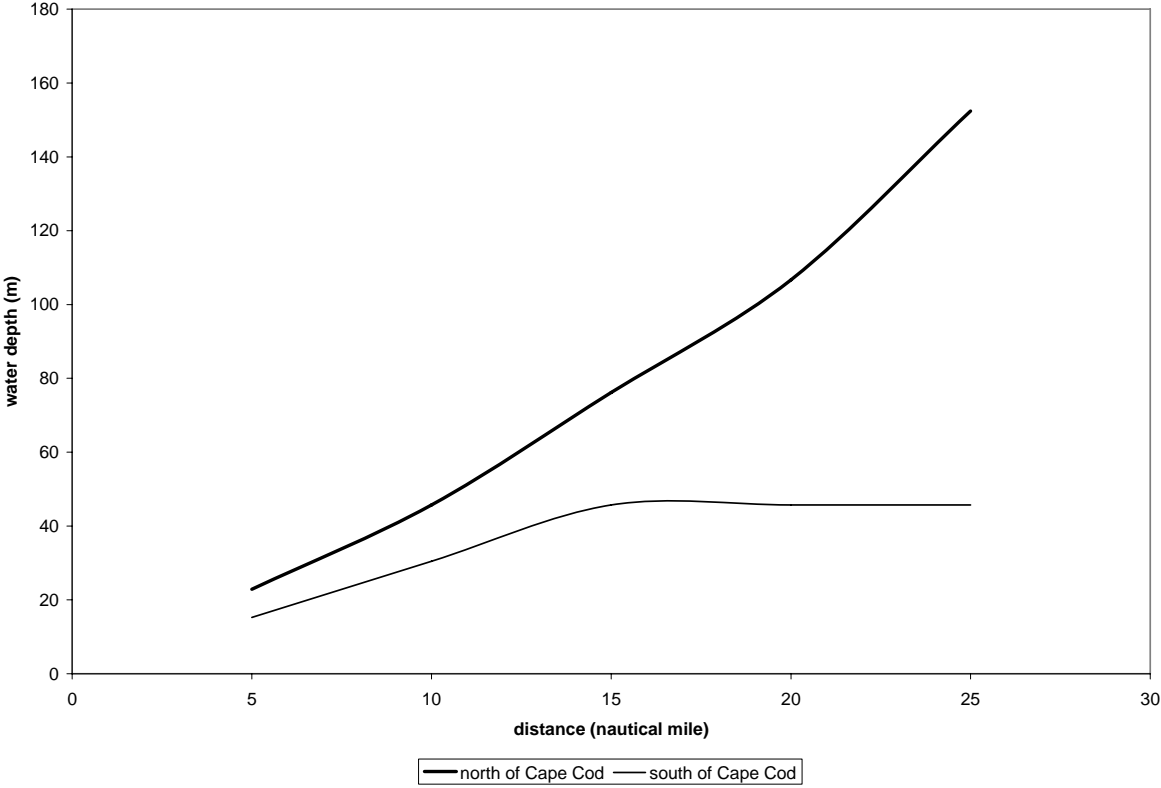
**Figure 6.6. Histograms of NPV and errors associated with key parameters (case 2).**



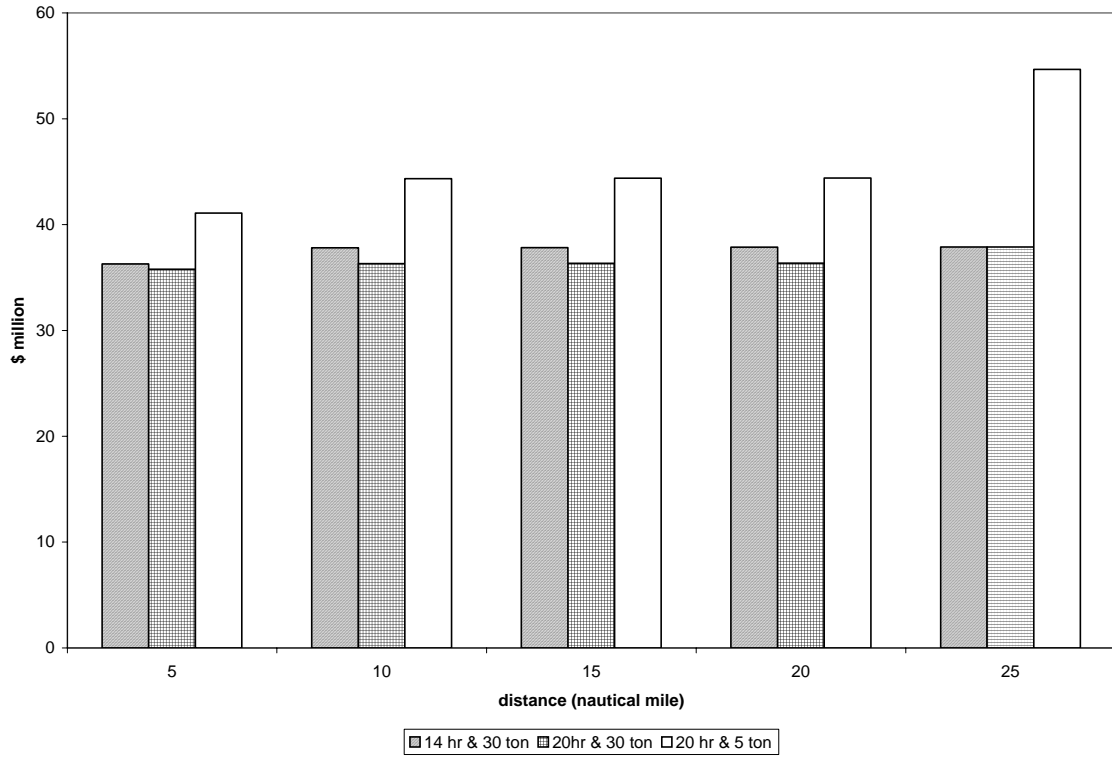
*Notes:* As specified in Table 6.4, the error distributions shown above are  $exp(\xi_m)$  for mortality,  $\xi_\gamma$  for temperature,  $exp(\xi_g)$  for fish weight growth,  $\xi_p$  for fish price, and  $\xi_{fp}$  for feed cost. Number of iterations = 5,000.



**Figure 6.7. Water depth by distance to shore.**



**Figure 6.8. Total cost by distance to shore (cod).**



## CHAPTER 7

# The Potential Economic Ramifications of Offshore Aquaculture

James Kirkley

---

*This chapter provides a broad overview of the economic feasibility and potential contributions to the U.S. economy of offshore aquaculture.*

### Introduction

Development and promotion of offshore aquaculture has been proposed as one approach for satisfying an increasing domestic demand for seafood and promoting community maintenance and development. In particular, considering the stable status of wild harvests, as regulatory strategies become increasingly restrictive and thus reduce the domestic, wild caught seafood supply, it will become increasingly difficult to satisfy rising domestic demand due to both population growth and more healthy food claims, even with expanding imports. In 2005, the U.S. total supply of edible fishery products equaled 11.8 billion pounds; domestic landings of edible product equaled 8 billion pounds; imports equaled 10.2 billion pounds; and exports equaled 6.4 billion pounds. Between 1995 and 2005, imports increased from 3.1 to 10.2 billion pounds, or by 7.1 billion pounds. Domestic landings decreased from 9.8 to 8 billion pounds during this same period. In contrast, during the same period between 1995 and 2005, production of domestic aquacultured products in the U.S. increased from 690.4 to 788.7 million pounds (NMFS, 1996, 1997 and 2007). There is, thus, substantial evidence to believe that aquaculture can succeed and help satisfy a growing domestic demand for seafood.

Successful development and promotion of offshore aquaculture, however, is not without substantial perils or problems. Potential problems exist, such as the accidental release of non-indigenous species (if such species are permitted), large-scale mortalities, lack of adequate infrastructure, immature technology, and inadequate economic incentives due to higher investment and production costs. These are all extremely important potential limitations, which will need to be addressed to successfully stimulate and develop offshore aquaculture, but there is an even more basic issue. Simply put: Is offshore aquaculture economically viable or feasible, and if so, what are the economic ramifications in terms of contributions to the U.S. economy?

This chapter provides a broad overview of the economic feasibility and potential contributions to the U.S. economy of offshore aquaculture. For the purpose of assessing economic feasibility, a series of bio-economic models (based on engineering type models and information) are initially developed.<sup>1</sup> The bio-economic and engineering models and information, however, are also used to assess initial stocking densities, growth and survivability, time required to reach marketable size, and subsequently, net returns. Five species or broad aggregates are considered: (1) Atlantic cod, (2) salmon, (3) winter flounder, (4) blue mussel, and (5) sea scallops. They represent, thus, three species of finfish and two species of shellfish.

---

<sup>1</sup> Chapter 6 provides a comprehensive discussion of the economic feasibility analysis and the corresponding models and assumptions.

For the finfish species, the finfish production technologies considered in this chapter involve large, offshore cage farms employing a high level of automation. Two different technologies are considered for mollusks: a longline system for grow-out is considered for the blue mussel, and a seabed seeding technology is considered for scallop grow-out. Subsequent to assessing economic feasibility, an input/output (I/O) model is used to determine the potential economic contributions of offshore aquaculture for the five selected species or products.<sup>2</sup> Economic impacts are expressed in terms of sales or output, income, and employment. All dollar values are expressed in terms of year 2005 constant dollar values. Impacts are assessed relative to direct, indirect, and induced impacts. Direct impacts reflect the economic impacts directly generated by the producing sector. Indirect effects reflect the economic impacts of economic activity supporting the producing sector (fuel dealers who sell the fuel necessary to power vessels used by aquaculture producers must also purchase fuel and other goods and services from other businesses, for example). Induced impacts reflect the economic activity generated by expenditures of wages and salaries received by individuals in all producing and support sectors (Kirkley et al., 2005).

The input/output model facilitates estimation and assessment of the economic contributions of the various aquaculture operations in terms of sales (or output), income, and employment generated. The I/O models developed for the assessment of the economic impacts consider the producers (for example, an aquaculture operation), wholesalers, grocery stores and fish markets, and restaurants—or, final consumer sector. In actuality, however, grocers and restaurants represent separate industries, and the associated economic impacts of these two sectors should really be attributed to these sectors independently. They could easily substitute other products for aquacultured products. They are, nevertheless included to illustrate the potential magnitude of how offshore aquaculture could contribute to the economy of the United States.

In this part, it is necessary to mention that shellfish aquaculture differs from finfish aquaculture because it does not need feed. Therefore, for shellfish aquaculture, indirect effects do not need to consider the feed industry, while for finfish aquaculture, they do. In addition, set-up and processing costs will differ. It might be helpful to compare some differences between them before making a detailed calculation.

### **The Economic Feasibility and Contributions of Shellfish Aquaculture**

Initially provided are an assessment and potential impacts for the shellfish species, blue mussels and sea scallops. Mussels will be grown on ropes suspended vertically from longline harness sets. Each harvest consists of a 120-meter-long horizontal longline held in place about seven meters below the surface by submerged flotation spheres and anchored to the bottom. Approximately 200 culture ropes are suspended from each longline to a depth of five meters above the seafloor. At full-scale operation, which is projected to be realized in three years, an offshore aquaculture plant will operate 120 longlines. Scallops will be grown using a seabed seeding technology. Scallops are to be seeded over a 143-acre site. The mussel operation is assessed over a 10-year period, and the scallop operation is assessed over a 20-year period.

---

<sup>2</sup> A description of the I/O model is presented in chapter 13, Kirkley et al. (2005), “A Users Guide to the U.S. National Offshore Aquaculture Model for Assessing Economic Impacts.

*Blue Mussel (Mytilus edulis)*

The growth of blue mussels, as well as the growth of scallops and finfish, is estimated based on a discrete time version of the Beverton-Holt (1957) model, which relates growth to number of animals and weight of animals. The time period considered for the economic feasibility of producing blue mussels via offshore aquaculture was determined by the useful life of longlines, which is ten years. The bio-economic assessment considers longline installation, spat collection, socking operation, maintenance, and harvesting. The assessment also includes purchase of a used vessel, which will be employed during the first three years, and then the purchase of a new vessel in the fourth year of the operation, which is the approximate time required to bring the operation up to full scale. All production activities are assumed to be equivalent to constant returns to scale; that is, a constant proportionate increase in all factors of production generates the same proportionate increase in outputs, or the production of mussels.<sup>3</sup>

The up front investment cost for a mussel operation is approximately \$1.1 million. This includes the purchase and installation of longlines, a used vessel, and other items essential to production. Additional costs include expendable supplies, vessel and equipment maintenance, and support for shore-side activities (Table 7.1). The total constant dollar cost of the operation over the 10-year period equals \$4.62 million.<sup>4</sup> Over the 10-year period, it is projected that the mussel operation will generate, after deducting costs, a net present value of approximately \$2.7 million (Table 7.2). The average annual harvest will be approximately 892 metric tons, or 1.97 million pounds per year. Average annual revenue will approximate \$1.2 million per year, with a product price of approximately \$0.60 per pound. The break-even price is \$0.35 per pound; that is, if prices received for scallops fall below \$0.35 per pound, it will not long be financially feasible to operate the mussel operation, based on assumptions above.

One problem with the initial feasibility analysis is the assumption of constant returns to scale. It is, thus, not feasible to assess the potential economic impacts of mussel operations if expanded. There is no information to indicate the potential number of mussel operations, and thus, our assessment of the potential economic contributions can only be made in terms of either gross sales for a single plant, or on a per-\$1-million-of-sales for mussel aquaculture basis.

Based on the national aquaculture input/output model, it is estimated that an annual gross revenue of \$1.2 million will generate a total of \$6.49 million in total sales or output, \$3.33 million in income, and 92 full- and part-time jobs for the U.S. economy (Table 7.3).<sup>5</sup> These impacts represent the impacts over all sectors, from the aquaculture operation to retail sales. The largest impacts are generated in the restaurant and primary producer (aquaculture operation) sectors. Retail sales by grocers generate a total of \$3.5 million in total sales or output, \$2.03 million in income, and 62 full- and part-time jobs. The aquaculture-producing sector generates \$2.67 million in total sales, \$1.14 million in income, and 25 full- and part-time jobs.

---

<sup>3</sup> Constant returns to scale is assumed for the production of all species.

<sup>4</sup> The constant dollar cost is based on a discount rate of 7 % per year and is necessary to adjust the dollar values for inflation and the opportunity cost of capital.

<sup>5</sup> Economic impacts, except employment, are in terms of year 2005 constant dollar values. Employment is expressed in terms of the number of full- and part-time jobs.

**Table 7.1. Basic production and cost requirements, blue mussels.**

Description	Unit	Value
longlines at full capacity	number/farm	120
longline installation cost <sup>a</sup>	\$/longline	10,000
expendable supplies <sup>b</sup>	\$/longline/year	1,700
used vessel acquisition	\$/vessel	70,000
used vessel maintenance	\$/vessel/year	10,000
used vessel upgrade & equipment <sup>c</sup>	\$/vessel	25,000
equipment maintenance	\$/year	5,000
used vessel variable and crew cost	\$/day	1,500
new custom vessel construction	\$	800,000
new custom vessel maintenance	\$/year	30,000
new vessel variable and crew cost	\$/day	1,000
on shore cost <sup>d</sup>	\$/year	173,000
annual discount rate		0.07

Notes:

- Including 2 anchors (\$2,000), 2 corner buoys (\$2,000), rope and chain (\$2,000), flotation (\$2,000), and assembly and deployment (\$2,000)
- Including spat collectors, grow out ropes, socking material, bag, etc.
- Including stripper/declumper/grader and continuous socking machine
- Including CEO/captain salary (\$100,000/year) and vessel dockage, etc. (\$20,000)

**Table 7.2. Estimated net present value, investment, harvest, and cost, blue mussels.**

Description	Unit	Value
net present value	\$ million	2.659
Investment <sup>a</sup>	\$ million	1.114
average fish harvest <sup>b</sup>	metric ton/year	892
total cost	\$ million	4.624
<b>Cost Share</b>		
longline installation	%	24.1
expendable supplies	%	15.5
vessel acquisition & maintenance	%	19.5
vessel variable cost (fuel, crew, etc.)	%	13.4
onshore and other	%	27.5
total	%	100

Notes:

- Longline system only
- At full capacity annual output is 1,200 metric tons

**Table 7.3. Economic contributions of single blue mussel operation, \$1.2 million in sales.**

<i>Impacts of Aquaculture Blue Mussels Offshore Shipments – Producers</i>				
	Direct Impacts	Indirect Impacts	Induced Impacts	Total Impacts
Labor Income Impacts (millions of dollars)	0.50	0.18	0.45	1.14
Output Impacts (millions of dollars)	0.73	0.58	1.36	2.67
Employment Impacts (full-time and part-time jobs)	9.87	3.75	11.86	25.48
<b>Impacts of Aquaculture Blue Mussels Offshore Shipments – Wholesalers</b>				
	Direct Impacts	Indirect Impacts	Induced Impacts	Total Impacts
Labor Income Impacts (millions of dollars)	0.03	0.01	0.02	0.06
Output Impacts (millions of dollars)	0.03	0.02	0.07	0.12
Employment Impacts (full-time and part-time jobs)	0.54	0.11	0.60	1.25
<b>Impacts of Aquaculture Blue Mussels Offshore Shipments – Grocers</b>				
	Direct Impacts	Indirect Impacts	Induced Impacts	Total Impacts
Labor Income Impacts (millions of dollars)	0.06	0.01	0.05	0.11
Output Impacts (millions of dollars)	0.04	0.01	0.15	0.20
Employment Impacts (full-time and part-time jobs)	2.12	0.11	1.26	3.49
<b>Impacts of Aquaculture Blue Mussels Offshore Shipments – Restaurants</b>				
	Direct Impacts	Indirect Impacts	Induced Impacts	Total Impacts
Labor Income Impacts (millions of dollars)	1.06	0.10	0.87	2.03
Output Impacts (millions of dollars)	0.60	0.28	2.63	3.50
Employment Impacts (full-time and part-time jobs)	37.04	2.24	22.76	62.04
<b>Impacts of Aquaculture Blue Mussels Offshore Shipments – All Sectors</b>				
	Direct Impacts	Indirect Impacts	Induced Impacts	Total Impacts
Labor Income Impacts (millions of dollars)	1.64	0.30	1.40	3.33
Output Impacts (millions of dollars)	1.40	0.89	4.21	6.49
Employment Impacts (full-time and part-time jobs)	49.57	6.22	36.48	92.27

*Sea Scallops (Placopecten magellanicus)*

The economic feasibility of using aquaculture to produce sea scallops is based on a 20-year life cycle. A 20-year cycle permits ten, two-year cycles of harvesting and marketing scallops. The farming operation is scaled to produce 100,000 pounds of scallop meat every two years. Baseline production assumptions include the following: 1) the farming site is two hours by boat from port; 2) the site is surrounded by markers with annual maintenance requirements of three hours of boat time; 3) the juvenile scallop collecting/depositing time per cycle is 142 days; 4) the farm area seeded is 143 acres; 5) scallops are sold at dockside for \$7 per pound of meat; 6)

the work day is 12 hours; and, 7) vessels are capable of capturing and bringing to the farming site an average of 40,000 juvenile scallops in one day.

Although a two-year production cycle is assumed, the equivalent annual production is 22.7 metric tons, or 50 thousand pounds per year. At \$7 per pound, the plant or production facility is projected to gross \$350.3 thousand per year. The input requirements (such as the number of buoys and moorings per farm, seeding density, etc.) are summarized in Table 7.4. The up front investment is \$52.7 thousand (Table 7.5). The expected net present value, or net return over the 20-year cycle, equals \$1.72 million. The total cost for one scallop operation over the 20-year period is \$2.11 million.

The annual economic contributions of the single scallop production facility equal \$1.98 million in sales or output, \$1.15 million in income, and 31 full- and part-time jobs. The production facility, itself, generates sales or output of \$730 thousand, \$430 thousand in income, and approximately 9 full- and part-time jobs. The largest contributions are generated by the restaurant sector—\$1.14 million in sales or output, \$670 thousand in income, and 21 full- and part-time jobs. Expanding the number of production facilities simply scales the magnitude of the impacts (for example, two plants would be expected to generate \$3.96 million in sales, \$2.3 million in income, and 62 full- and part-time jobs).

**Table 7.4. Basic production and cost requirements, sea scallop.**

Description	Unit	Value
marker buoys & moorings	number/farm	14
unit cost	\$/mooring set	3,000
annual mooring maintenance	\$/mooring set/year	150
total vessel cost	\$/day	2,000
seeding density	1,000 scallops/acre	40
mortality/loss rate to harvest	%	50
average size at harvest	lbs (meat)	0.035
onshore cost *	\$/year	20,000
annual discount rate		0.07

Note: \* Management and administration.



**Table 7.5. Estimated net present value, investment, harvest, and cost, sea scallop.**

Description	Unit	Value
<b><i>Cost</i></b>		
net present value	\$ million	1.723
investment <sup>a</sup>	\$	52,675
average scallop harvest <sup>b</sup>	metric ton/year	22.7
Total cost	\$ million	2.110
<b><i>Cost Share</i></b>		
marker buoys & moorings	%	2.5%
annual mooring maintenance <sup>c</sup>	%	1.0%
mooring maintenance <sup>d</sup>	%	5.4%
collecting/depositing cost <sup>d</sup>	%	78.9%
harvest cost <sup>d</sup>	%	1.6%
onshore cost	%	10.7%
Total	%	100%

*Notes:*

- a. Marker buoys and moorings
- b. Scallops are harvested every other year
- c. Fix maintenance cost per year
- d. Cost associated with vessel usage

**The Economic Feasibility and Contributions of Finfish Aquaculture**

Estimation and assessment of the economic feasibility and potential economic contributions of finfish aquaculture is considerably more complicated. A Beverton-Holt model is used to project growth, numbers (abundance), and weight (biomass) of fish. In addition, various feed conversion ratios were used to help estimate the cost of feed for various finfish species. Revenues were estimated using price times quantity on a monthly basis, and subsequently aggregated to an annual basis. Costs and required investment levels were obtained from a wide variety of sources, which are detailed in Chapter 6 of this report. Details of the various bio-economic models used to conduct the assessments are also presented in Chapter 6.

The economic feasibility and contributions of using aquaculture to produce the three species of finfish are examined in this report. The production technologies for all three finfish species involve large offshore cage farms utilizing high levels of automation. In addition, production of all three species relies upon purchasing fingerlings and subsequently stocking and growing them to marketable size. Except for salmon, the purchase of fingerlings accounts for the largest cost share—41.8 % of the total cost of producing cod, and 55.1% of the total cost of producing winter flounder. The purchase of salmon fingerlings accounts for 18.8 % of the total cost of producing salmon.

**Table 7.6. Economic contributions of sea scallop operation, \$350,300 in sales.**

<i>Impacts of Aquaculture Sea Scallops Offshore Shipments – Producers</i>				
	Direct Impacts	Indirect Impacts	Induced Impacts	Total Impacts
Labor Income Impacts (millions of dollars)	0.22	0.02	0.19	0.43
Output Impacts (millions of dollars)	0.09	0.07	0.57	0.73
Employment Impacts (full-time and part-time jobs)	3.51	0.41	4.95	8.87
<b>Impacts of Aquaculture Sea Scallops Offshore Shipments -- Wholesalers</b>				
	Direct Impacts	Indirect Impacts	Induced Impacts	Total Impacts
Labor Income Impacts (millions of dollars)	0.01	0.00	0.01	0.02
Output Impacts (millions of dollars)	0.02	0.00	0.02	0.05
Employment Impacts (full-time and part-time jobs)	0.16	0.03	0.17	0.36
<b>Impacts of Aquaculture Sea Scallops Offshore Shipments -- Grocers</b>				
	Direct Impacts	Indirect Impacts	Induced Impacts	Total Impacts
Labor Income Impacts (millions of dollars)	0.02	0.00	0.01	0.03
Output Impacts (millions of dollars)	0.01	0.00	0.04	0.06
Employment Impacts (full-time and part-time jobs)	0.62	0.03	0.37	1.03
<b>Impacts of Aquaculture Sea Scallops Offshore Shipments -- Restaurants</b>				
	Direct Impacts	Indirect Impacts	Induced Impacts	Total Impacts
Labor Income Impacts (millions of dollars)	0.35	0.03	0.29	0.67
Output Impacts (millions of dollars)	0.18	0.08	0.88	1.14
Employment Impacts (full-time and part-time jobs)	12.57	0.65	7.62	20.85
<b>Impacts of Aquaculture Sea Scallops Offshore Shipments – All Sectors</b>				
	Direct Impacts	Indirect Impacts	Induced Impacts	Total Impacts
Labor Income Impacts (millions of dollars)	0.60	0.05	0.50	1.15
Output Impacts (millions of dollars)	0.30	0.16	1.51	1.98
Employment Impacts (full-time and part-time jobs)	16.86	1.13	13.12	31.11

Atlantic Cod (*Gadus morhua*)

Cod aquaculture assumes that stocking and harvesting will be done on a year-round basis. Although the actual economic assessment is based on monthly activity, the average annual price equaled \$2.92 per pound. A 15-year period is used as the baseline assessment period. The baseline fixed cost per year is \$100 thousand. Operating costs are \$1,500 per day for fuel and other consumables, and personnel costs for a crew of four represent another \$1,500 per day. Annual production cost equals \$2.09/pound per year. Input requirements and associated costs involve purchasing cages, buying and installing moorings, acquiring fingerlings, supporting best management practices, and acquiring additional fixed and variable inputs (Table 7.7).

The up front investment cost ranges between \$2 and \$3.1 million (Table 7.8). The total cost of the project is between \$35.9 and \$59.9 million over the 15-year period. The variation is due to the possible production of baseline and high-end valued products. Expected production equals 177 metric tons, or 390.2 thousand pounds per month for a total of 4.7 million pounds per year. Gross revenue for the year is projected to equal \$13.7 million per year. The net present value over the 15-year period equals \$10.6 million for the baseline product, but appears to be negative (-\$13.4 million) for the high-end product. If the price falls below \$0.91 per pound, the baseline farm is no longer economically viable.

Revenues of \$13.7 million received by the farm generate total sales for the producing sector of \$38.8 million (Table 7.9). Of that total, the wholesale sector generates \$2.23 million in total sales; the grocery sector generates \$2.96 million in total sales; and the restaurant sector generates \$32.2 million in total sales. Total output generated by all sectors equals \$76.3 million; total income equals \$33.7 million; and total employment generated across all sectors equals 1,013 full- and part-time jobs. The largest levels of impact occur in the restaurant and producing sectors. Total employment generated in the restaurant sector equals 571 full- and part-time jobs, and total employment generated in the producing sector equals 367 full- and part-time jobs.

Atlantic Salmon (*Salmo salar*)

Atlantic salmon is already successfully cultured in the northeast United States, and Maine has several producers. Cage culture is the primary method for culturing of salmon. Analysis of the economic feasibility of salmon culture is based on a 15-year cycle. The farm is assumed to produce salmon on a year-round basis. The expected harvest of salmon is 169 metric tons per month, or 4.5 million pounds per year. The assessment is based on a price of \$1.81 per pound. It is anticipated that the salmon farm will generate revenues of \$8.1 million per year. Both a baseline and a high-end product are considered in the assessment.

The total cost over the 15-year period is between \$31.3 (baseline product) and \$46.5 million (high-end product). Up front investment equals \$3.1 million. The input and cost requirements are summarized in Table 7.10; the economic performance and returns are summarized in Table 7.11. Overall, a salmon farm producing 4.5 million pounds per year is expected to yield a net return between \$29.5 million (baseline) and \$14.3 million (high-end). The analysis also indicates that if the price falls below \$0.91 per pound, the farm is not profitable.

**Table 7.7. Basic production and cost requirements, Atlantic cod.**

Parameter	Description	Unit	Baseline Value	High-end Value
<i>V</i>	cage volume per cohort	m <sup>3</sup>	5,000	5,000
<i>acq</i>	cage purchase cost <sup>a</sup>	\$/m <sup>3</sup>	15.00	25
<i>inst</i>	cage mooring and installation cost	\$/m <sup>3</sup>	3.00	3.00
<i>cm</i>	cage operating and maintenance cost <sup>b</sup>	\$/m <sup>3</sup> /year	1.00	6
<i>stock</i>	number of fingerlings stocked per cohort	1,000 fish	150	150
<i>Sg</i>	stocking weight	gram/fish	50	50
$\varphi$	ratio of water weight to fingerling weight during transport to farm		5	5
<i>Sp</i>	fingerling cost	\$/fish	0.85	1.50
<i>Fp</i>	feed cost	\$/kg	0.60	0.73
<i>bfix</i>	vessel fixed cost	\$/year	100,000	150,000
<i>bvar</i>	vessel variable and crew cost <sup>c</sup>	\$/day	3,000	3,000
<i>Ld</i>	vessel payload	MT	30	30
<i>trip</i>	round trips per day		3	3
<i>Sh</i>	on shore cost <sup>d</sup>	\$/year	150,000	250,000
<i>ins</i>	insurance cost <sup>e</sup>	\$/year	50,000	300,000
<i>fmv</i>	feed management variable cost	\$/cohort/month	0	33.32
<i>scf</i>	solid control BMP plan fixed cost	\$/farm	0	1615.20
<i>scv</i>	solid control BMP plan variable cost	\$/month	0	21.15
<i>dcf</i>	drug and chemical control BMP plan fixed cost	\$/farm	0	1615.20
<i>dcv</i>	drug and chemical control BMP plan variable cost	\$/month	0	21.15
<i>Aff</i>	active feed monitoring fixed cost	\$/farm	0	10,000
<i>afv</i>	active feed monitoring fixed cost	\$/cohort/month	0	33.32
$\delta$	annual discount rate		0.07	0.07

Notes:

- a. Including feeder and other equipments
- b. Including fuel, utilities, diving, repair, etc.
- c. Including 4 crews (average \$25/hour)
- d. Including salaries for 1 manager and 2 office staff
- e. Insurance covers fish and other capital

**Table 7.8. Estimated net present value, investment, harvest, and cost, Atlantic cod.**

Output Variable	Description	Unit	Baseline Value	High-end Value
NPV	net present value	\$ million	10.620	-13.375
<i>I</i>	investment	\$ million	2.010	3.139
<i>X(T)</i>	average fish harvest	metric ton/month	177	177
<i>N(T)</i>	average number of fish harvested	fish/month	120,535	120,535
<i>W(T)</i>	average harvest fish size	Kg	1.47	1.47
$12 \cdot E[fq(t)]$	average feed quantity	metric ton/year	2,765	2,765
<i>Project Cost</i>	total cost	\$ million	35.871	59.867
<i>Cost Share</i>	cage installation	%	5.6	5.2
	cage maintenance	%	2.8	10.2
	boat and crew	%	6.0	4.4
	fingerlings	%	39.5	41.8
	feed	%	40.9	29.8
	onshore and other	%	5.2	8.5
	total	%	100	100

The potential economic impacts of one offshore salmon farm are quite significant. The producing sector generates \$18.7 million in total sales or output, \$8.2 million in income, and approximately 189 full- and part-time jobs relative to producing sector activities (Table 7.12). Restaurant sales generate the second highest level of total output—at \$17.2 million. The sale of salmon by restaurants, however, generates the highest level of income—approximately \$10 million. The number of full- and part-time jobs generated by restaurant activity equals 304. Total sales (or output), income, and employment of all sectors equal, respectively: \$38.7 million, \$19.6 million, and 534 full- and part-time jobs.

#### Winter Flounder (*Pseudopleuronectes americanus*)

Winter flounder is a highly valued flounder by New England and mid-Atlantic consumers. Domestic landings of winter flounder, however, have substantially declined over time. In the 1970s and 1980s, annual landings were typically between 25 and 40 million pounds. Between 1994 and 2004, annual total landings have ranged between 8 and 13 million pounds. Given its highly desirable characteristics, winter flounder is an excellent candidate for offshore aquaculture.

The economic feasibility of producing winter flounder is based on a cage operation and a 15-year period. Expected production is 125 metric tons per month, or 3.3 million pounds per year. The feasibility analysis assumes an average annual price of \$4.60 per pound, which is considerably higher than previously observed ex-vessel prices for domestic wild product. The assessment is based on a monthly analysis and then aggregated up to an annual basis; then assessed relative to a 15-year production cycle.

**Table 7.9. Economic contributions of cod operation, \$13.7 million in annual sales.**

<i>Impacts of Aquaculture Cod Offshore Shipments – Producers</i>				
	Direct Impacts	Indirect Impacts	Induced Impacts	Total Impacts
Labor Income Impacts (millions of dollars)	4.00	3.71	4.54	12.25
Output Impacts (millions of dollars)	11.69	13.50	13.64	38.83
Employment Impacts (full-time and part-time jobs)	148.61	99.04	118.99	366.65
<b>Impacts of Aquaculture Cod Offshore Shipments – Wholesalers</b>				
	Direct Impacts	Indirect Impacts	Induced Impacts	Total Impacts
Labor Income Impacts (millions of dollars)	0.55	0.10	0.44	1.09
Output Impacts (millions of dollars)	0.62	0.30	1.32	2.23
Employment Impacts (full-time and part-time jobs)	10.30	2.18	11.45	23.93
<b>Impacts of Aquaculture Cod Offshore Shipments – Grocers</b>				
	Direct Impacts	Indirect Impacts	Induced Impacts	Total Impacts
Labor Income Impacts (millions of dollars)	0.90	0.08	0.72	1.70
Output Impacts (millions of dollars)	0.56	0.22	2.18	2.96
Employment Impacts (full-time and part-time jobs)	31.85	1.67	18.91	52.43
<b>Impacts of Aquaculture Cod Offshore Shipments – Restaurants</b>				
	Direct Impacts	Indirect Impacts	Induced Impacts	Total Impacts
Labor Income Impacts (millions of dollars)	9.72	0.92	8.02	18.66
Output Impacts (millions of dollars)	5.54	2.53	24.16	32.23
Employment Impacts (full-time and part-time jobs)	340.59	20.61	209.33	570.53
<b>Impacts of Aquaculture Cod Offshore Shipments – All Sectors</b>				
	Direct Impacts	Indirect Impacts	Induced Impacts	Total Impacts
Labor Income Impacts (millions of dollars)	15.18	4.81	13.72	33.70
Output Impacts (millions of dollars)	18.41	16.54	41.30	76.25
Employment Impacts (full-time and part-time jobs)	531.36	123.51	358.68	1,013.54

**Table 7.10. Basic production and cost requirements, Atlantic salmon.**

Parameter	Description	Unit	Baseline Value	High-end Value
<i>v</i>	cage volume per cohort	m <sup>3</sup>	5,000	5,000
<i>acq</i>	cage purchase cost	\$/m <sup>3</sup>	15.00	25
<i>inst</i>	cage mooring and installation cost <sup>a</sup>	\$/m <sup>3</sup>	3.00	3.00
<i>cm</i>	cage operating and maintenance cost <sup>b</sup>	\$/m <sup>3</sup> /year	1.00	6
<i>stock</i>	number of fingerlings stocked per cohort	1,000 fish	45	45
<i>sg</i>	stocking weight	gram/fish	150	150
$\varphi$	ratio of water weight to fingerling weight during transport to farm		5	5
<i>sp</i>	fingerling cost	\$/fish	1.50	1.75
<i>fp</i>	feed cost	\$/kg	0.73	0.9
<i>bfix</i>	vessel fixed cost	\$/year	100,000	150,000
<i>bvar</i>	vessel variable and crew cost <sup>c</sup>	\$/day	3,000	3,000
<i>ld</i>	vessel payload	MT	30	30
<i>trip</i>	round trips per day		3	3
<i>sh</i>	on shore cost <sup>d</sup>	\$/year	150,000	250,000
<i>ins</i>	insurance cost <sup>e</sup>	\$/year	50,000	300,000
<i>fmv</i>	feed management variable cost	\$/cohort/month	0	33.32
<i>scf</i>	solid control BMP plan fixed cost	\$/farm	0	1615.20
<i>scv</i>	solid control BMP plan variable cost	\$/month	0	21.15
<i>dcf</i>	drug and chemical control BMP plan fixed cost	\$/farm	0	1615.20
<i>dcv</i>	drug and chemical control BMP plan variable cost	\$/month	0	21.15
<i>aff</i>	active feed monitoring fixed cost	\$/farm	0	10,000
<i>afv</i>	active feed monitoring fixed cost	\$/cohort/month	0	33.32
$\delta$	annual discount rate		0.07	0.07

Notes:

- a. Including feeder and other equipments
- b. Including fuel, utilities, diving, repair, etc.
- c. Including 4 crews (average \$25/hour)
- d. Including salaries for 1 manager and 2 office staff
- e. Insurance covers fish and other capital

**Table 7.11. Estimated net present value, investment, harvest, and cost, Atlantic salmon.**

Output Variable	Description	Unit	Baseline Value	High-end Value
NPV	net present value	\$ million	29,486	14,289
$I$	investment	\$ million	2,010	3,139
$x(T)$	average fish harvest	metric ton/month	169	169
$n(T)$	average number of fish harvested	fish/month	37,446	37,446
$w(T)$	average harvest fish size	kg	4.52	4.52
$12 \cdot E[fq(t)]$	average feed quantity	metric ton/year	2,619	2,619
<i>Project Cost</i>	total cost	\$ million	31.315	46.512
<i>Cost Share</i>	cage installation	%	6.4	6.7
	cage maintenance	%	3.2	13.2
	boat and crew	%	6.0	5.0
	fingerlings	%	24.0	18.8
	feed	%	54.5	45.3
	onshore and other	%	5.9	11.0
	total	%	100	100

Although the basic technology requires cages, actual production technology differs slightly for winter flounder than for cod and salmon. Stocking and harvesting are restricted to two-month periods per year; stocking occurs between March and April and harvesting occurs between November and December. Input and cost requirements are summarized in Table 7.13. The total cost of the operation over the 15-year period varies between \$7.31 million (baseline product) and \$8.8 million (high-end product). (See Table 7.14.) The estimated net present value for the baseline product is \$1.23 million over the 15-year period. The net present value for the high-end product is negative and equals -\$0.3 million. Additional analysis indicates that the operation is no longer economically feasible if the price received falls below \$1.59 per pound.

The farm operation is projected to produce 3.3 million pounds of flounder per year, while receiving approximately \$15.2 million in gross sales. The economic activity which might be generated from a flounder aquaculture operation is therefore quite significant. Total sales or output over all sectors is projected to be \$81.8 million; total income is projected to be \$37.9 million; and total employment is projected to equal 1154.7 full- and part-time jobs (Table 7.15). The primary producing sector generates the highest level of sales or outputs, but the restaurant sector generates the highest levels of both income and employment.



**Table 7.12. Economic contributions of salmon operation, \$8.1 million in annual sales.**

<b>Impacts of Aquaculture Salmon Shipments – Producers</b>				
	Direct Impacts	Indirect Impacts	Induced Impacts	Total Impacts
Labor Income Impacts (millions of dollars)	3.71	1.16	3.31	8.18
Output Impacts (millions of dollars)	4.71	4.05	9.96	18.72
Employment Impacts (full-time and part-time jobs)	72.11	30.16	86.54	188.81
<b>Impacts of Aquaculture Salmon Shipments – Wholesalers</b>				
	Direct Impacts	Indirect Impacts	Induced Impacts	Total Impacts
Labor Income Impacts (millions of dollars)	0.29	0.05	0.23	0.58
Output Impacts (millions of dollars)	0.33	0.16	0.70	1.19
Employment Impacts (full-time and part-time jobs)	5.49	1.16	6.10	12.75
<b>Impacts of Aquaculture Salmon Shipments – Grocers</b>				
	Direct Impacts	Indirect Impacts	Induced Impacts	Total Impacts
Labor Income Impacts (millions of dollars)	0.48	0.04	0.39	0.91
Output Impacts (millions of dollars)	0.30	0.12	1.16	1.58
Employment Impacts (full-time and part-time jobs)	16.99	0.89	10.08	27.96
<b>Impacts of Aquaculture Salmon Shipments – Restaurants</b>				
	Direct Impacts	Indirect Impacts	Induced Impacts	Total Impacts
Labor Income Impacts (millions of dollars)	5.18	0.49	4.27	9.95
Output Impacts (millions of dollars)	2.95	1.35	12.88	17.18
Employment Impacts (full-time and part-time jobs)	181.58	10.99	111.60	304.16
<b>Impacts of Aquaculture Salmon Shipments – All Sectors</b>				
	Direct Impacts	Indirect Impacts	Induced Impacts	Total Impacts
Labor Income Impacts (millions of dollars)	9.67	1.74	8.20	19.62
Output Impacts (millions of dollars)	8.29	5.68	24.71	38.67
Employment Impacts (full-time and part-time jobs)	276.16	43.20	214.32	533.68

**Table 7.13. Basic production and cost requirements, winter flounder.**

Parameter	Description	Unit	Baseline Value	High-end Value
<i>V</i>	cage volume per cohort	m <sup>3</sup>	5,000	5,000
<i>acq</i>	cage purchase cost	\$/m <sup>3</sup>	15.00	25
<i>inst</i>	cage mooring and installation cost <sup>a</sup>	\$/m <sup>3</sup>	3.00	3.00
<i>cm</i>	cage operating and maintenance cost <sup>b</sup>	\$/m <sup>3</sup> /year	1.00	6
<i>stock</i>	number of fingerlings stocked per cohort	1,000 fish	130	130
<i>Sg</i>	stocking weight	gram/fish	500	500
$\varphi$	ratio of water weight to fingerling weight during transport to farm		5	5
<i>Sp</i>	fingerling cost	\$/fish	2.00	2.00
<i>Sp</i>	feed cost	\$/kg	0.65	0.73
<i>bfix</i>	vessel fixed cost	\$/year	20,000	30,000
<i>bvar</i>	vessel variable and crew cost <sup>c</sup>	\$/day	3,000	3,000
<i>ld</i>	vessel payload	MT	30	30
<i>trip</i>	round trips per day		3	3
<i>sh</i>	on shore cost <sup>d</sup>	\$/year	40,000	70,000
<i>ins</i>	insurance cost <sup>e</sup>	\$/year	10,000	60,000
<i>fmv</i>	feed management variable cost	\$/cohort/month	0	33.32
<i>scf</i>	solid control BMP plan fixed cost	\$/farm	0	1615.20
<i>scv</i>	solid control BMP plan variable cost	\$/month	0	21.15
<i>dcf</i>	drug and chemical control BMP plan fixed cost	\$/farm	0	1615.20
<i>dcv</i>	drug and chemical control BMP plan variable cost	\$/month	0	21.15
<i>aff</i>	active feed monitoring fixed cost	\$/farm	0	10,000
<i>afv</i>	active feed monitoring fixed cost	\$/cohort/month	0	33.32
$\delta$	annual discount rate		0.07	0.07

*Notes:*

- a. Including feeder and other equipments
- b. Including fuel, utilities, diving, repair, etc.
- c. Including 4 crews (average \$25/hour)
- d. Including salaries for 1 manager and 2 office staff
- e. Insurance covers fish and other capital

**Table 7.14. Estimated net present value, investment, harvest, and cost, winter flounder.**

Output Variable	Description	Unit	Baseline Value	High-end Value
NPV	net present value	\$ million	1.234	-0.303
$I$	investment	\$ million	0.175	0.286
$x(T)$	average fish harvest*	metric ton/month	125	125
$n(T)$	average number of fish harvested*	fish/month	121,791	121,791
$w(T)$	average harvest fish size	kg	1.03	1.03
$12 \cdot E[fq(t)]$	average feed quantity	metric ton/year	175	175
<i>Project Cost</i>	total cost	\$ million	7.307	8.844
<i>Cost Share</i>	cage installation	%	2.4	3.2
	cage maintenance	%	1.2	6.3
	boat and crew	%	9.0	8.5
	fingerlings	%	66.7	55.1
	feed	%	14.3	13.3
	onshore and other	%	6.3	13.6
	total	%	100	100

Note: \* There are only two cohorts in a year (harvested in Nov. and Dec., respectively). Average annual harvest is the monthly figure times two.

## Summary and Conclusions

Despite apparent evidence that offshore aquaculture is not only economically feasible but also capable of generating substantial contributions to the U.S. economy, there remain many obstacles which may hinder its development and adoption. In this study, it was demonstrated that production of five species popular with U.S. consumers is economically feasible, provided certain conditions prevailed. Foremost among these conditions is that prices received will hold at certain levels. Given the increasing level of imports, it is quite possible that prices received for the primary products will decrease. Also, if resource conditions do improve in the future, the landings of wild-caught cod and winter flounder would likely expand. The sea scallop resource is already at a high level of biomass. In addition, all of the species can be produced near-shore as opposed to offshore, and there are likely to be cost savings for inshore or near-shore operations.

There remain many other concerns which may limit the development of offshore aquaculture outlined in other chapters in this report. There are potential uncertainties about obtaining loans, which will be necessary for satisfying up front investment costs. In all instances, these investment costs are quite high and will likely deter individuals or firms from investing in offshore aquaculture. There is considerable uncertainty about what constitutes best management practices (BMPs) for various operations. Present analysis does, however, support the development of offshore aquaculture in waters within 25 nautical miles of shore. Finally, it

is concluded that operations farther offshore will require larger projects, or farms, and higher levels of investment.

**Table 7.15. Economic contributions of flounder operation, \$8.1 million in annual sales.**

<b>Impacts of Aquaculture Winter Flounder Offshore Shipments – Producers</b>				
	Direct Impacts	Indirect Impacts	Induced Impacts	Total Impacts
Labor Income Impacts (millions of dollars)	5.34	3.50	5.20	14.03
Output Impacts (millions of dollars)	13.20	11.37	15.60	40.17
Employment Impacts (full-time and part-time jobs)	219.29	80.04	136.10	435.44
<b>Impacts of Aquaculture Winter Flounder Offshore Shipments – Wholesalers</b>				
	Direct Impacts	Indirect Impacts	Induced Impacts	Total Impacts
Labor Income Impacts (millions of dollars)	0.61	0.11	0.49	1.21
Output Impacts (millions of dollars)	0.69	0.33	1.47	2.48
Employment Impacts (full-time and part-time jobs)	11.46	2.42	12.73	26.61
<b>Impacts of Aquaculture Winter Flounder Offshore Shipments – Grocers</b>				
	Direct Impacts	Indirect Impacts	Induced Impacts	Total Impacts
Labor Income Impacts (millions of dollars)	1.00	0.09	0.81	1.89
Output Impacts (millions of dollars)	0.62	0.24	2.42	3.29
Employment Impacts (full-time and part-time jobs)	35.41	1.86	21.02	58.30
<b>Impacts of Aquaculture Winter Flounder Offshore Shipments – Restaurants</b>				
	Direct Impacts	Indirect Impacts	Induced Impacts	Total Impacts
Labor Income Impacts (millions of dollars)	10.81	1.03	8.92	20.75
Output Impacts (millions of dollars)	6.16	2.81	26.86	35.83
Employment Impacts (full-time and part-time jobs)	378.70	22.92	232.75	634.37
<b>Impacts of Aquaculture Winter Flounder Offshore Shipments – All Sectors</b>				
	Direct Impacts	Indirect Impacts	Induced Impacts	Total Impacts
Labor Income Impacts (millions of dollars)	17.76	4.72	15.40	37.89
Output Impacts (millions of dollars)	20.67	14.76	46.35	81.78
Employment Impacts (full-time and part-time jobs)	644.87	107.24	402.61	1154.72

## References

Kirkley, J., J. Duberg, and J. Ward. (2005). A User's Guide to the U.S. National Offshore Aquaculture Model for Assessing Economic Impacts, prepared for NOAA Fisheries.

National Marine Fisheries Service (NMFS). 1996. Fisheries of the United States 1995. U.S. Department of Commerce, National Oceanic and Atmospheric Administration, National Marine Fisheries Service, Office of Science and Technology, Fisheries Statistics Division.

National Marine Fisheries Service (NMFS). 1997. Fisheries of the United States 1996. U.S. Department of Commerce, National Oceanic and Atmospheric Administration, National Marine Fisheries Service, Office of Science and Technology, Fisheries Statistics Division.

National Marine Fisheries Service (NMFS). 2007. Fisheries of the United States 2005. U.S. Department of Commerce, National Oceanic and Atmospheric Administration, National Marine Fisheries Service, Office of Science and Technology, Fisheries Statistics Division.

*This page intentionally left blank.*

## CHAPTER 8 Potential Economic Impacts of U.S. Offshore Aquaculture

Gunnar Knapp

---

*In this chapter, we discuss two types of potential economic impacts of U.S. offshore aquaculture:*

- *Employment and Income Impacts: Potential employment and income which might be created, directly and indirectly, from U.S. offshore aquaculture.*
- *Market-Driven Impacts: Potential impacts of U.S. offshore aquaculture on prices and production volumes of U.S. wild and farmed fish, and market-driven changes in net economic benefits to U.S. fishermen, fish farmers and consumers.*

*Our focus is on describing the general nature of these types of economic impacts, and the factors that may affect their potential magnitude.<sup>1</sup>*

### **Challenges in Assessing Economic Impacts of U.S. Offshore Aquaculture**

There are several major challenges in assessing potential economic impacts of United States offshore aquaculture, which are similar to the challenges in assessing economic potential for U.S. offshore aquaculture which we noted in Chapter 2.

First, potential United States offshore aquaculture is very diverse. The United States has a very large exclusive economic zone with waters ranging from arctic to tropical. There are many different species which could be farmed in the U.S. EEZ, using many different types of technologies. The economic impacts of offshore aquaculture may vary widely for different regions, species, and technologies.

Second, the economic impacts of United States offshore aquaculture will depend on how it is regulated. Regulations for offshore aquaculture will directly affect what technologies may be used, where aquaculture might develop, what species might be farmed, the scale of potential projects, how long it takes for projects to be permitted and developed, costs of taxation, costs of environmental monitoring, the extent of local hire and control, and so forth. Thus part of the answer to the question to “what kind of economic impacts will offshore aquaculture have?” depends on the answer to the question “what kind of economic impacts do we want offshore aquaculture to have?”

A third challenge is that the U.S. offshore aquaculture industry is still in its infancy. Although we can speculate about what future U.S. offshore aquaculture may look like, we do not yet know what technologies may evolve, which species and regions will have the most economic

---

<sup>1</sup> Note that this chapter does not address economic impacts associated with potential environmental “externalities” of offshore aquaculture, which are addressed in other chapters of this report. Note also that the discussion of economic impacts in this chapter should be distinguished from cost-benefit analysis, or formal comparison of costs and benefits of offshore aquaculture.

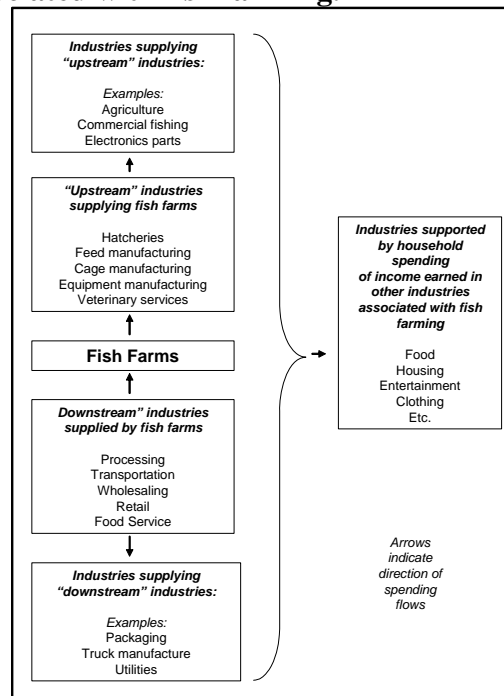
potential, what inputs the evolving U.S. offshore aquaculture industry may purchase, what the markets for its products will be, or what prices those products may command.

Perhaps most importantly we do not know what the *scale* of future U.S. offshore aquaculture may be, or how fast it will grow to achieve that scale. Most (although not all) economic impacts of offshore aquaculture would be roughly proportional to the scale of production. Depending on the scale of production, the economic impacts of offshore aquaculture could be very small—or very large.

### Employment and Income Impacts of Offshore Aquaculture

Figure 8.1 provides a simple categorization of industries associated with fish farming—those industries which depend in some way on fish farming. We may group these industries into six categories:

**Figure 8.1. Industries associated with fish farming.**



- Fish farms. These are aquaculture operations growing fish or shellfish.
- "Upstream industries" supplying fish farms. These are industries from which the fish farms purchase direct inputs. Among the industries which account for the greatest share of fish farm purchases are hatcheries, feed manufacturing, and cage and equipment manufacturing.
- "Downstream" industries supplied by fish farms. These are industries in the distribution chain from fish farms to consumers, including processing, transportation, wholesaling, retail and food service.



- Industries supplying upstream industries. These are industries from which the “upstream” industries purchase inputs. For example, the feed manufacturing industry purchases raw material for making fish feed from both the agriculture and the commercial fishing industries.
- Industries supplying downstream industries. These are industries from which the “downstream industries purchase inputs. For example, the processing industry purchases boxes from the packaging industry.
- Industries supported by household spending. These are industries throughout the entire economy that are supported by spending of household income earned in the other industries.

Clearly the nature and degree of association with fish farming varies widely among these different categories of industries. There are only a few industries which would disappear entirely without fish farming, such as cage manufacture. However, there are many industries, across many sectors of the economy—which benefit in some way from fish farming.

Figure 8.1 helps to illustrate two simple but important points. First, the economic impacts of fish farming are larger—potentially much larger—than those which occur at fish farms. We cannot count the employment created by aquaculture simply by adding up the jobs at aquaculture companies.

Second, the economic impacts of fish farming are spread over a far greater geographic area than the communities where fish farms are located or from which they are supported. While the hatchery supplying a fish farm may be located relatively near the farm, the company manufacturing the cage or the restaurant selling the fish may be located thousands of miles away.

One indicator of the relative significance of “upstream industries” in aquaculture production is the share of purchased product inputs in gross output value. As shown in Table 8.2, purchased inputs accounted for 69% of total gross output value of Canadian aquaculture in 2005, and feed purchases alone accounted for 31%. The shares of different inputs varied between provinces, reflecting different mixes of species in total production.

Viewed in a different way, gross value added in Canadian aquaculture was only 31% of gross output in 2005. Thus more than two-thirds of gross output value was generated in other “upstream” industries.

**Table 8.1. Estimated share of selected expenditures in gross output value of Canadian aquaculture, by province, in 2005.**

	Newfound-land	Prince Edward Island	Nova Scotia	New Brunswick	Quebec	Ontario	British Columbia	CANADA TOTAL
<b>Purchased product inputs</b>	<b>59%</b>	<b>24%</b>	<b>47%</b>	<b>75%</b>	<b>40%</b>	<b>43%</b>	<b>74%</b>	<b>69%</b>
Feed	28%		24%	29%		24%	38%	31%
Eggs and fish for growout	7%	8%	7%	10%	2%	5%	3%	6%
Processing services	4%	2%	0%	4%	0%		10%	6%
Goods transportation & storage	4%	1%	2%	2%	1%	1%	7%	4%
Energy	2%	2%	2%	1%	8%	3%	2%	2%
Maintenance & repairs	2%	3%	1%		3%	1%	3%	3%
Insurance premiums		0%	1%	2%	1%	0%	2%	2%
Rental & leasing expenses	1%	2%	0%	1%	1%	1%	1%	1%
Professional services	2%	1%	1%	1%	2%	1%	1%	1%
Therapeutants			2%	1%			2%	2%
<b>Gross value added (factor cost)</b>	<b>33%</b>	<b>76%</b>	<b>53%</b>	<b>25%</b>	<b>59%</b>	<b>57%</b>	<b>27%</b>	<b>31%</b>
Salaries & wages	11%	37%	17%	12%	19%	17%	11%	13%
Finfish share of production volume	61%	0%	64%	94%	25%	100%	87%	75%

Source: Calculated from value-added account data in Statistics Canada, *Aquaculture Statistics 2005*, Catalogue no. 23-222-XIE. Estimates were based on taxation data and a sample of 148 establishments. Blank cells indicate estimates were not available.

### Estimating Total Employment and Income Impacts of Fish Farming

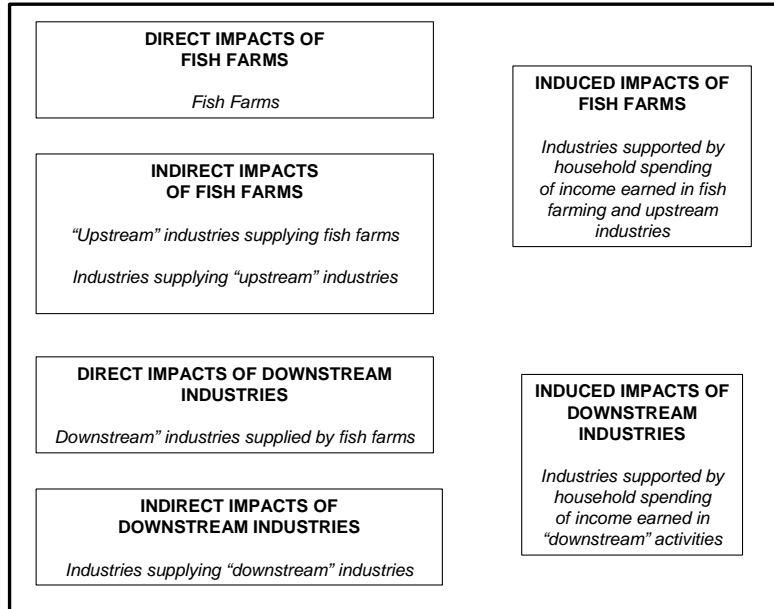
Adding up how many people work on fish farms and what they earn is a relatively straightforward process. Speculating about how many people might work on future offshore fish farms is also relatively straightforward (although highly uncertain given uncertainty about the future scale and characteristics of the industry). It is far less straightforward to measure the full economic impacts, across all industries, of existing fish farms--or to project the potential full economic impacts of future fish farms.

The standard technique for estimating economic impacts of an industry is input-output analysis, which calculates economic impacts using assumptions about inter-industry purchases per dollar of output of an industry. These are then used to calculate three types of economic impacts: “direct,” “indirect,” and “induced.” Applied to fish farming, “direct impacts” are those occurring within the fish farming industry; “indirect” impacts are those driven by purchases of the fish farming industry from other industries, and “induced impacts” are those driven by household spending of income created by direct and indirect impacts. . Each of these types of impacts is typically measured in three ways: annual average employment, wage and salary income, and sales or “output.”

Input-Output analysis typically measures only the impacts of an industry and its associated upstream activities. If we wish to measure the impacts of the “downstream” activities of processing and distributing farmed fish, we may apply the same approach to estimating the direct, indirect and induced impacts of these industries (net of those associated with fish production).

A significant challenge for input-output analysis is that it requires extensive data on inter-industry purchases. This is particularly a challenge for marine aquaculture, partly because it relies heavily on purchases from other industries, and partly because it is a relatively new industry for which relatively little data are available.

**Figure 8.2. Types of economic impacts of fish farming estimated by economic impact modeling.**



The National Offshore Aquaculture Model is an input-output model which was developed for the specific purpose of estimating potential economic impacts of offshore aquaculture. Chapter 7 of this report uses this model to estimate economic impacts for hypothetical offshore farming operations for five different species. For each species, the model required specific assumptions about the scale of the operation and different kinds of expenditures such as farm installation costs, vessel maintenance, feed costs, etc. The model then calculates direct, indirect and induced impacts generated by the farming operation as well as “downstream” activities.

Details of the model’s economic impact calculations are presented in Chapter 7. The purpose of our brief discussion here is to contrast the relative scales of different kinds of projected impacts, and of impacts from different kinds of farming.

As shown in the first row of Table 8.2, the direct employment impacts of fish farming account for between only 11% and 19% of the projected total employment impacts of farming from all upstream and downstream activities as well as induced activity in the rest of the economy. As shown in the fourth row, the total impacts attributable to farming (as opposed to downstream activities) represent only 27% to 38% of total impacts.

These estimates serve to emphasize the point made above: the potential total economic impacts of offshore fish farming are much larger than those which would occur at the farming operations alone—potentially five to ten times larger. Put differently, simply adding up jobs and wages at the farms would greatly underestimate the total economic impacts created by offshore farming.

**Table 8.2. Share of estimated employment impacts of potential offshore aquaculture operations.**

	Blue mussel	Sea scallop	Cod	Atlantic salmon	Winter flounder
Farming direct	11%	11%	15%	14%	19%
Farming indirect	4%	1%	10%	6%	7%
Farming induced	13%	16%	12%	16%	12%
<b>Farming total</b>	<b>27%</b>	<b>29%</b>	<b>36%</b>	<b>35%</b>	<b>38%</b>
Downstream direct	43%	43%	38%	38%	37%
Downstream indirect	3%	2%	2%	2%	2%
Downstream induced	26%	26%	24%	24%	23%
<b>Downstream total</b>	<b>73%</b>	<b>71%</b>	<b>64%</b>	<b>65%</b>	<b>62%</b>
Combined direct	53%	54%	52%	52%	56%
Combined indirect	7%	4%	12%	8%	9%
Combined induced	39%	42%	35%	40%	35%
<b>Combined total</b>	<b>100%</b>	<b>100%</b>	<b>100%</b>	<b>100%</b>	<b>100%</b>

Source: Full-time and part-time employment impacts estimated for different types of offshore aquaculture operations using the National Offshore Aquaculture Model, presented in Chapter 7.

Note however that the total economic impacts depend on the extent to which offshore aquaculture would increase total U.S. fish consumption, as opposed to offsetting fish imports. If production from U.S. offshore aquaculture replaces an equivalent amount of imports, then some of the model's projected downstream impacts--particularly those deriving from retail and food service--should be excluded, because these activities would occur regardless of whether future U.S. consumption is from U.S. farms or imported fish.

Table 8.3 shows the model's projections of employment impacts per thousand metric tons of annual production for each species.<sup>2</sup> The important point we wish to emphasize here is not the specific impacts projected for any particular species, but rather the fact that there is wide variation between species in the scale of potential economic impacts associated with a given production volume. This is to be expected, given the fact that technologies of fish farming vary widely depending upon what species is being farmed and how it is being farmed.

### Estimates of Fish Farming Employment

Table 8.4 shows estimates of annual average employment in aquaculture per thousand metric tons of production, for various regions and species, from a number of different sources. The estimates are for inshore marine aquaculture and onshore aquaculture, which likely differ in their employment impacts from those of potential future U.S. offshore farms. The definitions of "employment" and the methodologies used to derive the estimates of employment vary considerably between sources.

The employment estimates are only for direct employment in fish farming. As discussed above, total employment created by aquaculture in these regions, after accounting for indirect

<sup>2</sup> Note that these projections depend upon the specific assumptions used in the model about the scale and technology of each farming operation.

and induced upstream impacts of upstream and downstream activities, is likely much larger—potentially five to ten times as great.

**Table 8.3. Estimated employment per thousand metric tons of annual production in potential offshore aquaculture operations.**

	Blue mussel	Sea scallop	Cod	Atlantic salmon	Winter flounder
Farming direct	11	155	70	36	146
Farming indirect	4	18	47	15	53
Farming induced	13	218	56	43	91
<b>Farming total</b>	<b>29</b>	<b>391</b>	<b>173</b>	<b>93</b>	<b>290</b>
Downstream direct	45	588	180	101	284
Downstream indirect	3	32	12	6	18
Downstream induced	28	360	113	63	178
<b>Downstream total</b>	<b>76</b>	<b>980</b>	<b>305</b>	<b>170</b>	<b>480</b>
Combined direct	56	743	250	136	430
Combined indirect	7	50	58	21	71
Combined induced	41	578	169	106	268
<b>Combined total</b>	<b>104</b>	<b>1370</b>	<b>477</b>	<b>263</b>	<b>770</b>

Source: Full-time and part-time employment impacts estimated for different types of offshore aquaculture operations using the National Offshore Aquaculture Model, presented in Chapter 7.

The employment impacts associated with a given volume of aquaculture production vary widely depending upon the species, region, and technology and scale of production. In general, labor productivity is much higher in large-scale salmon farming, resulting in the creation of fewer direct farming jobs per thousand metric tons of production than smaller-scale farming of other species.

Norwegian salmon and trout farming—probably the most labor-efficient large-scale aquaculture in the world—creates about 5 direct farming jobs per thousand metric tons of production. In contrast, aquaculture in general, reflecting smaller-scale production of a mix of finfish and shellfish species, tends to create between 20 and 50 direct farming jobs per thousand metric tons of production.

Detailed cost and employment data compiled annually for the Norwegian aquaculture industry help to illustrate the basic point that the number of jobs created by fish farming depend upon scale, technology and economics. Between 1992 and 2003, Norwegian salmon and trout production more than quadrupled while total employment in Norwegian salmon and trout farming declined (Figure 8.3). As a result, employment per thousand metric tons of salmon and trout production fell from 24.4 to 5.7 (Figure 8.4)—reflecting a dramatic increase in labor productivity as the scale of the industry increased.

**Table 8.4. Selected estimates of aquaculture employment, various species and regions.**

Species	Region	Year	Source & Notes	Live weight (metric tons)	Estimated employment	Estimated employment per thousand metric tons
All aquaculture	Newfoundland	2005	1	8,163	200	25
	Prince Edward Island			18,921	620	33
	Nova Scotia			8,917	250	28
	New Brunswick			37,657	1,250	33
	Quebec			1,215	155	128
	Ontario			4,000	150	38
	British Columbia			73,195	1,275	17
	CANADA TOTAL			152,068	3,900	26
All aquaculture	Austria	1997	2	4,274	379	89
	Belgium			1,471	112	76
	Denmark			38,250	698	18
	Finland			16,365	809	49
	France			211,205	10,342	49
	Germany			59,069	3,193	54
	Greece			54,947	2,711	49
	Ireland			35,101	1,275	36
	Italy			211,919	4,923	23
	Netherlands			97,640	564	6
	Portugal			8,781	1,452	165
	Spain			233,693	7,851	34
	Sweden			6,523	480	74
	United Kingdom			128,525	2,705	21
EU TOTAL	1,107,763	54,029	49			
All aquaculture	Europe	1998	3	1,315,000	57,000	43
Salmon	N. Brunswick	2000	4	29,100	1,683	58
Salmon	Maine	2002	5	6,695	240	36
Salmon	Scotland	1997	6	99,197	1,647	17
Salmon	Scotland	2002	7	143,000	1,552	11
Salmon & trout	Norway	2000	8	488,839	3,631	7
		2005		645,387	3,054	5
Species other than salmon & trout	Norway	2000	8	1,439	400	278
		2005		11,507	606	53
Catfish	Mississippi	2001	7	172,789	3,000	17

See following page for sources & notes.

**Table 8.4. (continued).**

**Selected Estimates of Aquaculture Employment, Various Species and Regions: Sources & Notes**

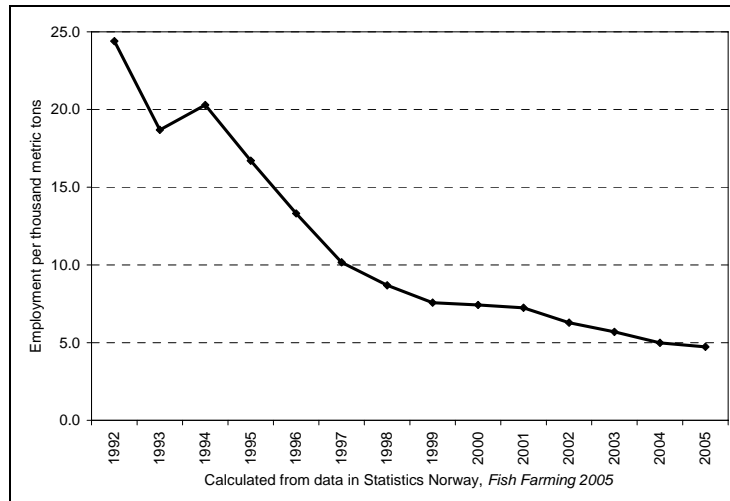
General notes: To the extent possible, employment data are estimates of full-time-equivalent employment in fish farming (excluding upstream or downstream impacts, including processing). The kind of employment data collected and/or estimated varies between studies. See notes for individual sources for additional details.

- (1) Fisheries and Oceans Canada. 2006. Canadian Aquaculture Industry, 2004-2005: Key Figures. [www.dfo-mpo.gc.ca/Aquaculture/ref/kf0405\\_e.htm](http://www.dfo-mpo.gc.ca/Aquaculture/ref/kf0405_e.htm).
- (2) MacAlister Elliott and Partners, Ltd. 1999. *Forward Study of Community Aquaculture: Summary Report*. Prepared for European Commission Fisheries Directorate General. Note: Species mix varies widely between EU countries. Employment estimates are for full-time-employment in production.
- (3) Commission of the European Communities. 2002. A Strategy for the Sustainable Development of European Aquaculture. Brussels 19.9.2002, COM(2002) 511 final. Note: Reported production volume is for 2000. Estimated 1998 employment was "at least 80,000 full or part-time workers, equivalent to 57,000 full-time jobs" (page 4).
- (4) Stewart, Len (Aquaculture Strategies, Inc.) 2001. *Salmon Aquaculture in New Brunswick: Natural Development of Our Marine Heritage*. Prepared for New Brunswick Salmon Growers Association Aquaculture Strategies. Note: Estimated person-years employment includes 157 in hatcheries, 624 in growout, 537 in processing, 240 in direct services, and 125 in "selling, administration & other." 77.3% of jobs were full-time, 9.6% were part-time, and 13.1% were seasonal."
- (5) O'Hara, Frank, Charles Lawton and Matthew York (Planning Decisions, Inc.). 2003. *Economic Impact of Aquaculture in Maine*. Prepared for the Maine Aquaculture Innovation Center. Note: Includes employment at three companies producing 15 million pounds of salmon annually of "over 240 full-time workers" in "freshwater and ocean farming operations, processing plants, and administrative and sales positions."
- (6) Highlands and Islands Enterprise and The Scottish Office. 1998. *The Economic Impact of Salmon Farming, Final Report*. Prepared by Public and Corporate Economic Consultants (PACEC) and Stirling Aquaculture. 124 p. Employment is estimated FTE employment in smolt production and salmon production. The study estimated that additional FTE employment of 4777 is created in "processing, supplier & induced."
- (7) Scottish Executive, 2004. *Scottish Economic Report: March 2004. Scottish Salmon Farming*. <http://www.scotland.gov.uk/library5/finance/ser04-16.asp>. Note: Estimates are for FTE employment of 1552 in smolt and salmon farming. Additional FTE employment of 4728 for salmon farming, 1024 for farming suppliers, and 520 for processing suppliers.
- (8) Statistics Norway. 2007. *Fish Farming 2005*. [www.ssb.no/nos\\_fiskeoppdrett](http://www.ssb.no/nos_fiskeoppdrett). Note: Includes employment in hatcheries.
- (9) Hanson, Terrill, Stuart Dean, and Stan Spurlock. *Economic Impact of the Farm-Raised Catfish Industry on the Mississippi State Economy*. Department of Agricultural Economics, Mississippi State University. Note: Includes only employment in catfish production. Additional employment of 3671 was reported in catfish processing. Production of 172,789 metric tons is volume of catfish processed in Mississippi.

**Figure 8.3. Norwegian salmon and trout aquaculture: total production and total employment.**



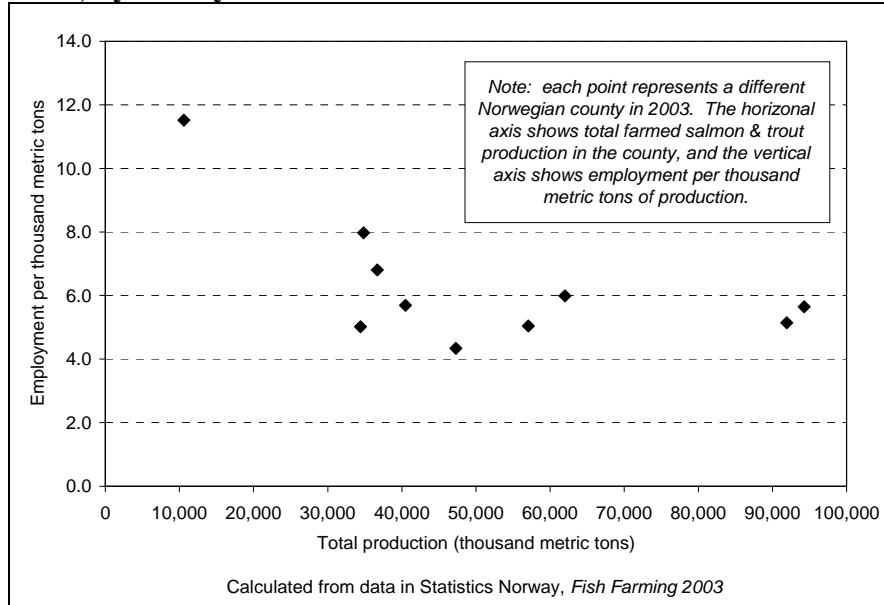
**Figure 8.4. Norwegian salmon and trout aquaculture: employment per thousand metric tons of production.**



Norwegian aquaculture data also help to illustrate that even farming of the same species in the same country may have different job impacts in different locations—likely reflecting differences in industry scale. As shown in Figure 8.5, there were significant differences between Norwegian counties in the employment per thousand metric tons of production in 2003.



**Figure 8.5. Norwegian salmon and trout aquaculture: Employment per thousand metric tons of production, by county.**



In general, because of the more difficult working conditions offshore, and the higher cost of transporting workers to offshore facilities, offshore fish farms are likely to be more mechanized and have fewer people working on the farm sites per metric ton of production than inshore farms growing the same species. Put differently, where it is possible to replace offshore workers with machines, offshore farm operators are likely to try to do so. This effect will be amplified to the extent that offshore farms are larger scale than inshore farms.<sup>3</sup>

However, some parts of offshore fish farming operations may employ more labor than inshore operations producing comparable species and volumes. For example, because of longer distances from shore facilities to farms, offshore farms may create relatively more jobs in transporting fish, feed, equipment and people to and from farms.<sup>4</sup>

### Potential Total Employment Created by U.S. Offshore Aquaculture

Clearly the employment created by U.S. offshore aquaculture would depend upon the volume of offshore aquaculture production, the mix of species which are farmed, and the scale and technology of individual farming operations. However, given observed levels of employment in existing aquaculture, it is possible to make reasonable estimates about the potential scale of total U.S. employment which might be created by U.S. offshore aquaculture.

<sup>3</sup> As discussed in other chapters, not all offshore farming operations would necessarily be large-scale or capital intensive.

<sup>4</sup> Note, however, that locating a farm farther offshore does not necessarily imply a greater transportation distance from shore facilities. Depending on terrain and infrastructure development, the distance from a shore facility straight out to an offshore farm may be shorter than the distance along the coast to a suitable inshore farming site.

**Table 8.5. Potential employment created by U.S. offshore aquaculture implied by different combinations of assumptions.**

	Assumed direct farming employment per thousand metric tons	Assumed Annual Offshore Production (metric tons)		
		50,000	100,000	500,000
Direct farming employment only	5	250	500	2,500
	20	1,000	2,000	10,000
	50	2,500	5,000	25,000
Assuming 2 total jobs per direct farming job	5	500	<b>1,000</b>	<b>5,000</b>
	20	<b>2,000</b>	<b>4,000</b>	<b>20,000</b>
	50	<b>5,000</b>	10,000	50,000
Assuming 5 total jobs per direct farming job	5	1,250	<b>2,500</b>	<b>12,500</b>
	20	<b>5,000</b>	<b>10,000</b>	<b>50,000</b>
	50	<b>12,500</b>	25,000	125,000
Assuming 10 total jobs per direct farming job	5	2,500	5,000	25,000
	20	<b>10,000</b>	20,000	100,000
	50	<b>25,000</b>	50,000	250,000

Note: Relatively more likely combinations of assumptions are shown in **bold**.

Table 8.5 shows the potential total employment implied by different combinations of three assumptions:

- Total annual production. The table shows implications of annual production from 50,000 to 500,000 metric tons.
- Direct farming employment per thousand metric tons. The table shows implications of direct employment ranging from 5 jobs per thousand metric tons (large-scale highly efficient Norwegian salmon and trout farming) to 50 jobs per thousand metric tons (averages across all aquaculture in some regions).
- Ratio of total employment to direct farming employment. The table shows implications of between 2 and 10 total jobs per direct farming jobs. Note that the lower assumption would exclude “downstream” employment created in transportation, wholesaling, retail and food service, on the assumption that in the absence of U.S. offshore aquaculture these jobs would be created by fish imports.

As can be seen in the table, these different assumptions imply a very wide range of potential total employment. However, we may make some reasonable inferences about the relative likelihood of different combinations of assumptions. First, employment would grow over time as the scale of total production increases. Thus the estimates in the left-hand column are more likely to represent employment created over the first ten years, while estimates in the right hand column become more likely over a longer period.

Second, as the total volume of offshore aquaculture production increases it is likely that labor efficiency would increase, resulting in fewer (perhaps 5-20) direct farming jobs per thousand metric tons of production.

Third, as the total volume of offshore aquaculture production increases it is increasingly likely that U.S. offshore production would be displacing imports rather than increasing U.S. consumption. Thus the total net increase in jobs created per direct farming jobs might tend to decline as the scale of production increases.

Given this reasoning, the figures shown in bold in the table represent relatively more likely combinations of assumptions. In general, it seems reasonable to conclude that if the United States produced 500,000 metric tons of fish annually in offshore aquaculture, this would increase total U.S. employment by between 5,000 and 50,000 jobs.

### **Comparing Employment in Wild Fisheries and Aquaculture**

Table 8.6 provides similar estimates of average annual employment per thousand metric tons in several wild fisheries. As in aquaculture, there is wide variation between species in how much employment is created in harvesting a given volume of fish. For any given species, employment created in by fish harvesting also varies from year to year, reflecting differences in total harvest volumes. In general, the ranges of average annual employment per thousand metric tons in these wild fisheries are comparable to those for aquaculture shown in Table 8.4.

An important difference between aquaculture and wild fisheries is that employment in wild fisheries is more seasonal. For example, peak monthly employment in Alaska salmon fisheries, which occur primarily in the summer, is more than four times as high as average annual employment. This means that wild fisheries tend to provide jobs for relatively more workers, working relatively less of the year, to produce a given volume of fish.

In comparing wild fisheries and aquaculture, such as comparing the employment estimates in Tables 8.6 and 8.4, it is important to keep in mind that the policy choice faced by the United States is not between harvesting fish in wild fisheries or growing fish in farms. With most United States wild fisheries fully exploited, is not an option for the United States to produce significantly more fish in wild fisheries. Rather, the policy choice is how much fish the United States will grow in fish farms. Even if commercial fishing tended to employ far more workers than aquaculture—which available data suggest is not the case—we would not have the option of creating more jobs by increasing commercial fish harvests. In contrast, aquaculture does provide an opportunity to create more jobs in fish production.

### **What Kinds of Jobs Will Offshore Aquaculture Create?**

On average, the jobs created in offshore aquaculture are likely to be higher-skilled and higher-paying than the jobs in onshore and inshore aquaculture for similar species. These jobs will include, for example, operation and maintenance of vessels and remote monitoring and feeding facilities and fish nutrition and fish health specialists.

**Table 8.6. Estimated average annual employment per thousand metric tons of harvest, selected wild fisheries.**

Area	Species	Year	Harvest (thousands of metric tons)	Estimated average annual employment	Estimated employment per thousand metric tons	Ratio, maximum to average annual employment
Alaska	Salmon	2000	322	4,295	13	4.5
		2001	349	3,761	11	4.5
		2002	282	3,073	11	4.4
		2003	333	3,424	10	4.4
		2004	363	3,526	10	4.4
		2005	434	3,817	9	4.3
Alaska	Halibut	2000	33	1,413	43	1.9
		2001	34	1,383	41	1.8
		2002	35	1,356	38	2.0
		2003	35	1,327	38	1.9
		2004	35	1,279	37	1.9
		2005	34	1,132	34	2.1
Alaska	Sablefish	2000	16	453	28	2.3
		2001	14	466	33	2.0
		2002	15	437	30	2.1
		2003	16	463	29	1.8
		2004	18	450	25	2.0
		2005	17	449	27	2.0
British Columbia	All species	2000	146	4600	32	N/A
		2001	192	5400	28	N/A

Sources: Alaska employment data : Alaska Department of Labor and Workforce Development, Research and Analysis Division ([almis.labor.state.ak.us](http://almis.labor.state.ak.us)). Alaska salmon harvests: Alaska Commercial Fisheries Entry Commission ([www.cfec.state.ak.us](http://www.cfec.state.ak.us)). Alaska sablefish and halibut harvests: National Marine Fisheries Service, Annual Commercial Landings Statistics ([http://www.st.nmfs.gov/st1/commercial/landings/annual\\_landings.html](http://www.st.nmfs.gov/st1/commercial/landings/annual_landings.html)). British Columbia harvests: Ministry of Agriculture and Lands ([http://www.al.gov.bc.ca/fish\\_stats/statistics.htm](http://www.al.gov.bc.ca/fish_stats/statistics.htm)); British Columbia employment: British Columbia Ministry of Management Services, British Columbia's Fisheries & Aquaculture Sector, September 2002.

As with other higher-skilled and higher paying jobs, not all of the new jobs created by U.S. offshore aquaculture will necessarily be taken by current residents of those communities nearest offshore aquaculture facilities. The industry is likely to seek the most qualified employees it can find from a broader regional or national pool of workers with the requisite skills. However, local communities may be able to influence local hiring through training programs or tax incentives. Local training or hiring requirements could potentially be incorporated in enabling regulations for offshore aquaculture.

Commercial fishermen would be well-skilled for and could potentially work in many of the jobs that might be created by offshore aquaculture, particularly those that involve vessel operations, maintenance of offshore operations, and transportation of fish. However, some (but not all) kinds of offshore aquaculture—particularly large-scale corporate farms—may involve a very different working environment than the small-scale, family owned business that

characterize much (but not all) of the United States commercial fishing industry. Jobs in offshore aquaculture are likely to have similar advantages (stable year-round employment, health-care benefits, opportunities for training and advancement) and disadvantages (non-local ownership and management, company bureaucracy) typically associated with larger companies operating in remote areas. Some but not all fishermen and other coastal community residents would welcome these job opportunities.

In considering the types of jobs created by offshore aquaculture, it is important to keep in mind the point--emphasized earlier in this chapter--that most of these jobs will not be working on offshore farms or working for offshore aquaculture companies. Rather, most of the jobs will be in a wide variety of upstream and downstream activities ranging from hatcheries, feed manufacturing, fish processing and distribution (more obvious examples) to soybean farming.

### **Market-Driven Impacts of Offshore Aquaculture**

We next review potential “market-driven impacts” of U.S. offshore aquaculture on prices and production volumes of U.S. wild and farmed fish, how these might affect net economic benefits of fishing and aquaculture to U.S. fishermen, fish farmers and consumers.

Clearly, aquaculture can have dramatic impacts on markets for wild fisheries. As we discuss in more detail below, prices paid to United States wild salmon fishermen and processors fell dramatically as world farmed salmon production expanded during the 1990s--causing significant economic difficulties for Alaska salmon fishermen, processors and fishing communities (Knapp et al, 2007). U.S. shrimp fishermen have experienced similar effects of competition from farmed fish.

Given this experience, it is not surprising that many commercial fishermen oppose fish farming. But the public policy considerations relevant to market-driven impacts of U.S. offshore aquaculture go beyond how competition from farmed fish affects prices of wild fish. They also include the benefits to consumers of lower fish prices, the long-term impacts of aquaculture on demand for fish (including wild fish), and the benefits to wild fisheries and consumers deriving from changes in wild fisheries driven by competition. Perhaps most importantly, they include the fact that aquaculture production will continue to expand globally—and most market driven impacts of aquaculture will occur—regardless of whether the United States rejects or embraces offshore aquaculture.

### **Theoretical Framework for Analysis of Market-Driven Impacts**

Basic supply and demand analysis provides a useful theoretical framework for thinking about how aquaculture may affect prices and net benefits to fishermen, fish farmers, and consumers. Below we first discuss potential short-run effects resulting from the effects of aquaculture on fish supply. We then discuss potential longer-run effects resulting from the effects of aquaculture on fish demand. Finally, we discuss the relative extent to which these effects are experienced by U.S. or foreign groups, and the extent to which U.S. aquaculture policy is able to influence the effects of aquaculture on prices and benefits to different groups. Our discussion applies to the effects of all aquaculture, not just to offshore aquaculture.

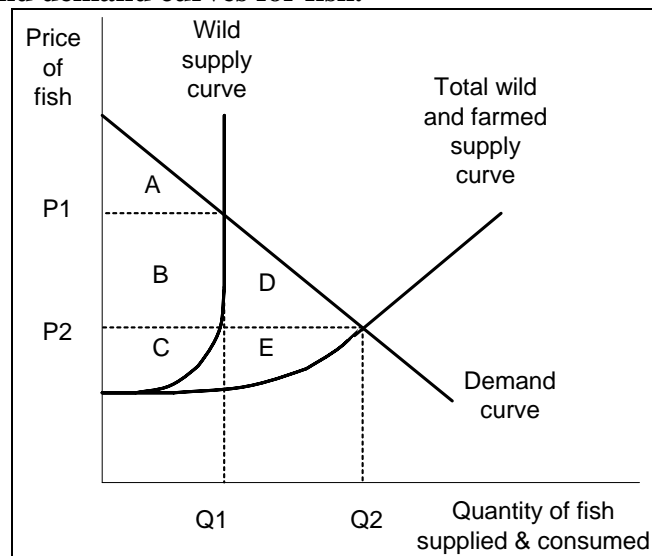
*Short-Run Market-Driven Impacts of Aquaculture*

Suppose that prior to the development of aquaculture all fish supply is from a wild fishery. The supply curve for fish shows the total volume of fish offered for sale at any given price (Figure 8.6). The supply curve is initially upward sloping, and becomes vertical at the maximum annual quantity available from the wild fishery (which we assume is limited by regulation).<sup>5</sup>

The intersection of the wild supply curve with the demand curve determines the equilibrium price  $P_1$  and the equilibrium quantity sold  $Q_2$ . At this price, the area of the graph labeled A shows “consumer surplus,” or the difference between what consumers would have been willing to pay for fish (as shown by the demand curve) minus the price  $P_1$  that they actually pay. Together, areas B and C show “producer surplus,” or the difference between the price received by wild fish producers and the price for which they would have been willing to supply the fish.

Consumer surplus is a measure of net benefits to consumers from the fishery. Producer surplus is a measure of net benefits to fishermen from the fishery. Total benefits to society from the fishery are represented by areas  $A + B + C$ .

**Figure 8.6. Supply and demand curves for fish.**



Now suppose that aquaculture provides a new source of fish supply.<sup>6</sup> The effect of the development of aquaculture is to shift the supply curve to the right, to the new “total wild and farmed supply curve.” This new total supply curve is the horizontal sum of the wild supply curve and an upward sloping farmed supply curve (which is not shown in the graph).

<sup>5</sup> To simplify the discussion we assume that prices do not affect fish supply by affecting fish stocks, which can result in a backward-bending supply curve such as that depicted for an equilibrium common-property fishery in Chapter 8.

<sup>6</sup> To simplify the discussion we assume initially that wild fish and farmed fish are identical products and sell for the same price.

As supply shifts from the old “wild supply curve” to the new “total wild and farmed supply curve,” the equilibrium price falls from  $P_1$  to  $P_2$ , and the equilibrium quantity supplied and consumed increases from  $Q_1$  to  $Q_2$ . At the new lower price there is a slight decline in the volume of wild fish supplied.

At the new equilibrium, consumer surplus is now represented by the sum of areas A, B and D, while producer surplus is now represented by the sum of areas C and E.

How are different groups been affected by the introduction of aquaculture in the short run?

- Fishermen are harmed. Their producer surplus declines from areas  $B + C$  to only area C, or by an amount represented by area B.
- Fish farmers benefit. They earn producer surplus represented by area E.
- Consumers benefit. Their consumer surplus increases from area A to areas  $A + B + C$ .

Total benefits to society increase from areas  $A + B + C$  to areas  $A + B + C + D + E$ . Areas  $D + E$  represent an increase in net benefits to society from aquaculture, which are respectively the consumer surplus and producer surplus from aquaculture. However, there is a redistribution of the benefits of the wild fishery from fishermen to consumers by an amount represented by area B. Put simply, in the short run, if aquaculture depresses the price of wild fish, fishermen lose and consumers gain by an equivalent total amount. Note that the relative scale of these effects on fishermen, consumers and fish farmers depend upon the assumptions we make about the shape of the supply and demand curves.

Because there are far fewer fishermen than consumers, the effects upon individual fishermen are far greater than the effects on individual consumers. As the price falls, an individual fisherman may see a very large drop in his income. An individual consumer will experience a correspondingly large drop in the price of the fish she buys--but this will not be anywhere as significant for her overall welfare as the loss of income is for the fisherman.

#### Long-Run Market-Driven Impacts of Aquaculture

The preceding analysis assumes that the demand for fish is unchanged by the introduction of aquaculture. However, over time introducing new supply from aquaculture is likely to increase demand for fish, shifting the demand curve out.

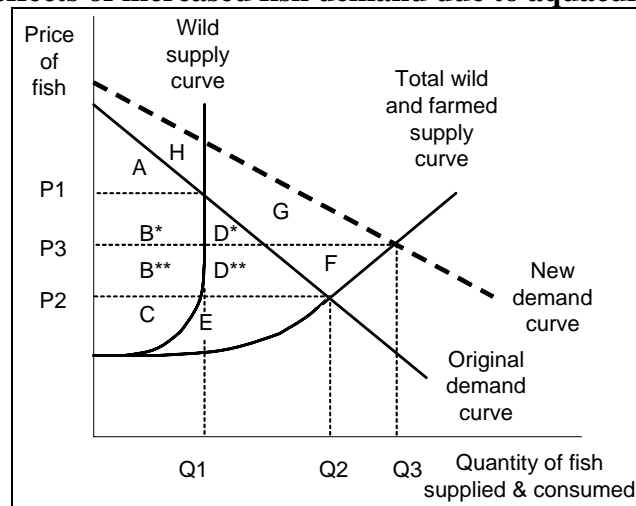
There are several reasons for which new supply from aquaculture is likely to increase fish demand over time. First, at any given time, demand for fish reflects consumers’ tastes and preferences, which in turn reflect their past consumption experiences. If a particular fish species is expensive, consumers who have not eaten it in the past are less likely to buy it in a store or order it in a restaurant. However, if the price falls and consumption increases (as depicted by the increase in consumption from  $Q_1$  to  $Q_2$  in Figure 8.6), new consumers may try the fish. If they enjoy eating it and develop a taste for it, over time they may be willing to pay a higher price for it than they would have previously.

Second, consumer demand for fish is limited by its availability in stores and restaurants. Even if consumers like a fish and are willing to pay a high price for it, they won't buy it if it is not in their local stores or on their local menus. As aquaculture supply expands, fish are offered for sale in more geographic locations, at more kinds of stores and restaurants, and at more times of the year—thus increasing the total demand at any given price.

Third, fish farmers engage in marketing in a systematic effort to increase demand. They recognize that their economic success depends critically on growing the market for their products. Marketing by fish farmers is not just advertising to consumers. Rather, it is a systematic approach to understanding and responding to the needs of both consumers and store and restaurant buyers, reflected in (for example) product forms, quality standards, packaging, and timing and volume of fish deliveries, long-term contracts, supply guarantees, payment terms, etc. Without competition from aquaculture, fishermen have far less incentive to engage in marketing, particularly when prices are high, because they are limited by nature in the volume of fish that they can supply.

Figure 8.7 illustrates potential effects of an increase in fish demand due to aquaculture. The equilibrium price increases from  $P_2$  to  $P_3$ , and the quantity of fish supplied and consumed increases from  $Q_2$  to  $Q_3$ .

**Figure 8.7. Potential effects of increased fish demand due to aquaculture.**



How does an increase in fish demand affect how different groups are affected by the introduction of aquaculture?

- Fishermen are not harmed as much. Their producer surplus declines by an amount represented by area  $B^*$ , rather than by the combined areas  $B^* + B^{**}$ .
- Fish farmers benefit more. Their producer surplus increases by an amount represented by the combined areas  $E + D^{**} + F$ , rather than by only area  $B$ .
- Some consumers lose but others benefit. As the price rises from  $P_2$  to  $P_3$ , those consumers whose demand was represented by the original demand curve experience a



loss of consumer surplus represented by areas  $B^{**} + D^{**}$ . However, new consumers (as well as former consumers who enjoy fish more) experience an increase in consumer surplus represented by areas  $H + G$ .

Higher demand increases total benefits to society by an amount represented by areas  $H + G + F$ , which includes both new consumer surplus (areas  $H + G$ ) as well as new producer surplus for fish farmers (area  $F$ ). Higher demand also reduces the extent to which aquaculture results in a shift of net benefits from fishermen to consumers. Note that if aquaculture results in a sufficiently great increase in demand, there may be no long-term effect on the price and fishermen may not be harmed at all.

Another potential change in demand over time may be a differentiation in consumer demand between wild and farmed fish. Some consumers may perceive wild fish as superior to farmed fish, and be willing to pay a higher “premium” price for wild fish than for farmed fish. To the extent that such a wild demand “premium” emerges, it would further mitigate the long-term effects of aquaculture on wild fishermen.

#### Market-Driven Impacts of Aquaculture on Americans

The preceding analysis has considered the effects of aquaculture on fishermen, fish farmers and consumers without regard to the question of whether these groups are American or foreign. Suppose however that fish are traded freely, and we are interested in how aquaculture may specifically affect American fishermen, fish farmers, and fish consumers, and overall net benefits to Americans.

Consider first, for purposes of illustration, the eight “either/or” scenarios, shown in Table 8.7, in which fishermen, fish farmers, and consumers are either all Americans or all foreigners. Fishermen stand to “lose” from aquaculture (due to lower prices) while fish farmers and consumers stand to gain.<sup>7</sup>

The economic effects of fish farming *on Americans* clearly depend on whether fishermen, fish farmers, and consumers are Americans:

- Scenarios 1-3: If no American fishermen are catching a particular fish species, then aquaculture clearly benefits Americans, by providing economic opportunity for American fish farmers, reducing prices and expanding supply for American consumers, or both.
- Scenario 4: If fishermen, fish farmers and consumers are all Americans, aquaculture increases net benefits to Americans by providing economic opportunities to American fish farmers. As discussed above for Figure 8.4, American fishermen lose and American consumers gain by an equivalent amount from the decline in prices.

---

<sup>7</sup>For purposes of illustration, in this section we ignore the possibility that aquaculture may expand fish demand, thus partially or even fully offsetting negative effects of aquaculture on prices and on fishermen.

**Table 8.7. Potential implications of aquaculture for Americans.**

Scenario	Who Producers & Consumers are			How Americans are affected*			Change in net benefits to Americans	Area of Figure X representing change in net benefits to Americans
	Fishermen	Farmers	Consumers	Fishermen	Farmers	Consumers		
1	Foreign	US	US	No effect	Gain	Gain	Increase	B+D+E
2	Foreign	US	Foreign	No effect	Gain	No effect	Increase	E
3	Foreign	Foreign	US	No effect	No effect	Gain	Increase	B+D
4	US	US	US	Lose	Gain	Gain	Increase	D+E
5	US	Foreign	US	Lose	No effect	Gain	No net change	
6	US	Foreign	Foreign	Lose	No effect	No effect	Decrease	-B
7	US	US	Foreign	Lose	Gain	No effect	Uncertain	E-B
8	Foreign	Foreign	Foreign	No effect	No effect	No effect	No effect	

\*Table assumes that aquaculture harms fishermen by lowering prices, benefits consumers by reducing prices and expanding supply, and benefits farmers. Note that if aquaculture expands demand sufficiently, prices will not necessarily fall.

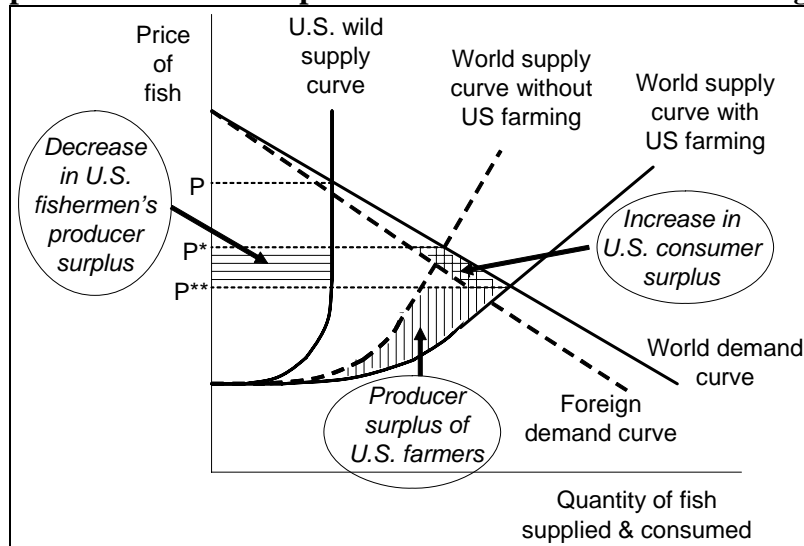
- **Scenario 5:** If foreign fish farmers reduce prices paid by American consumers to U.S. fishermen, there is no change in net benefits to Americans. Again, American fishermen lose and American consumers gain by an equivalent amount from the decline in prices.
- **Scenario 6:** The worst situation for Americans occurs if the fishermen (who stand to lose) are Americans while the fish farmers and consumers (who stand to gain) are foreigners.
- **Scenario 7:** If both American fishermen and American fish farmers export fish to a foreign market, then the effect on net benefits to Americans is uncertain: it depends on the relative magnitudes of fishermen’s loss from lower prices and farmers’ gain from increased economic opportunity.

Table 8.7 depicts “either/or” situations in which fishermen, fish farmers and consumers are either all American or all foreign. However, the situation most relevant to discussion of U.S. offshore aquaculture is one in which consumers may include both foreigners and Americans, and fish farmers may include both foreigners and Americans. The relevant policy issue for discussion of U.S. offshore aquaculture is how U.S. production may affect Americans, given that foreign aquaculture production is likely to grow—with major effects on world seafood markets—regardless of the extent of U.S. production.

Figure 8.8 depicts a situation in which the United States is the only producer of wild fish, but fish are consumed by both foreigners and Americans, and farmed fish may be produced by both foreigners and Americans. Even if there is no U.S. fish farming, the effect of foreign fish farming on Americans is to depress the price paid to U.S. fishermen from P to P\* and to reduce prices and increase consumption by American consumers. The effect of U.S. fish farming would be to shift the world supply curve further to the right, depressing the price further from P\* to P\*\*.

The effects on Americans include a further decrease in U.S. fishermen's producer surplus, a further increase in U.S. consumer surplus, and producer surplus for U.S. fish farmers.

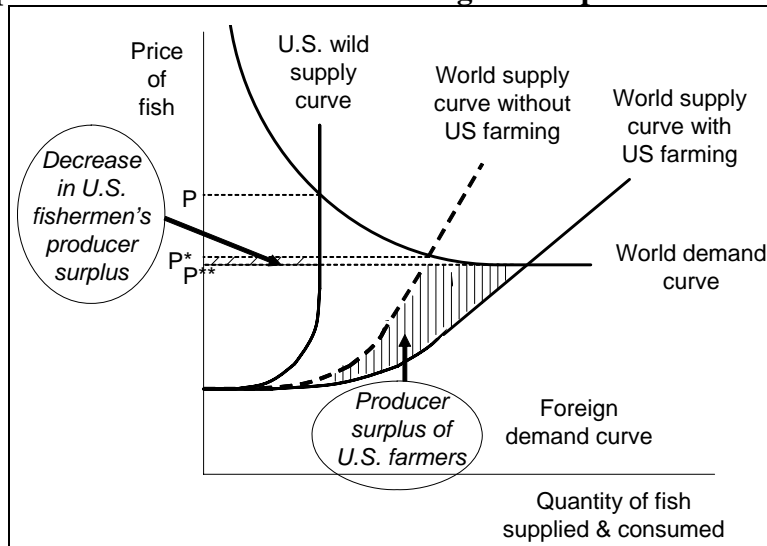
**Figure 8.8. Comparison based on the presence/absence of U.S. fish farming.**



The relative scale of these effects depends on the shapes of the U.S. and foreign demand and supply curves, and in particular on the price sensitivity (“elasticity”) of world demand and supply. Suppose, as depicted in Figure 8.9, that as prices decline and consumption increases world demand becomes relatively more price-sensitive (elastic). At high prices and low consumption the demand curve is relatively more vertical; at low prices and high consumption the demand curve becomes relatively more horizontal.

If there is no U.S. fish farming, foreign fish farming still results in a large increase in supply over wild production, which significantly depresses the price received by U.S. fishermen from  $P$  to  $P^*$ . However, if American fish farmers now increase world supply further, there will be only a limited further effect on prices. Thus, in this situation, American fish farming would have relatively little effect on U.S. fishermen, while providing significant benefits for U.S. farmers.

**Figure 8.9. The potential effect of U.S. fish farming on fish prices.**



Summary: Theoretical Market-Driven Impacts of Aquaculture

We may summarize the foregoing theoretical discussion of market-driven effects of aquaculture as follows:

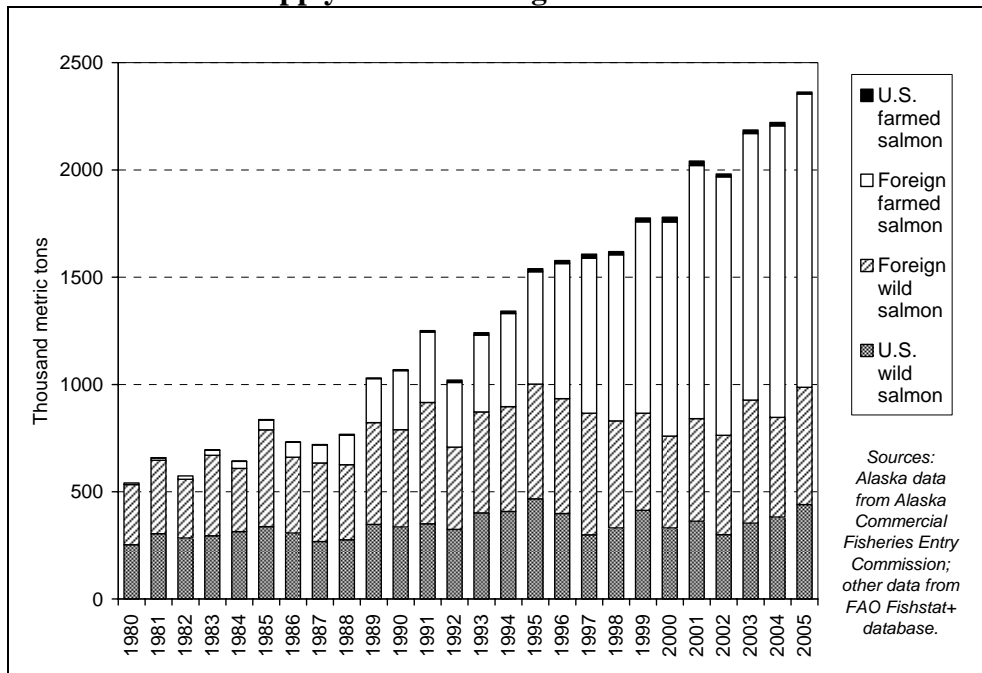
- In the short run, aquaculture tends to lower fish prices by increasing the supply of fish, harming fishermen but benefiting consumers.
- Over the longer run, aquaculture tends to increase the demand for fish as consumers become more familiar with fish; as fish become available in more locations, at more times, and in more product forms; and as fish farmers engage in systematic marketing to expand demand. Increasing demand tends to offset the effects of higher supply, resulting in less of a decline in fish prices.
- How American fishermen and consumers would be affected by U.S. offshore farming of a particular species depends upon their relative shares of world supply and demand for that species (and closely competing species), and the price-sensitivity (“elasticity”) of world fish demand and supply for that species (and closely competing species). Net benefits to Americans from U.S. aquaculture will tend to be higher, the greater the extent to which consumers are Americans and competing wild and farmed producers are foreigners.
- Even if foreign fish farming significantly depresses prices for U.S. fishermen, that does not necessarily mean that U.S. fish farming would result in further significant effects on fish prices and U.S. fishermen. If demand becomes more price-responsive (“elastic” at lower prices and higher consumption volumes, the effect of U.S. farmed production on U.S. fishermen may be relatively small.

### Market-Driven Impacts of Salmon Aquaculture

In considering potential market-driven impacts of U.S. offshore aquaculture, it is useful to consider what the market-driven impacts of salmon aquaculture have been for the United States. As shown in Figure 8.10, in the early 1980s, world salmon production was almost entirely from wild fisheries. Between 1980 and 1985, United States wild salmon accounted for 46% of total world salmon supply. Over the next twenty-five years, world farmed salmon production<sup>8</sup> grew very rapidly, resulting in a dramatic increase in total world supply and a decline in the share of U.S. wild salmon in world supply to 17% for the years 2000-2005.

Almost all of the farmed salmon production occurred outside the United States, which has never accounted for more than 3% of farmed salmon production since the 1980s (and only 1% since 2002). The fact that the United States is not a significant producer of farmed salmon is not due to absence of potential farming sites or other technical or economic constraints. Rather, it primarily reflects policy choices, including a ban on finfish farming in Alaska and regulatory constraints in other states. Our purpose in the subsequent discussion is not to argue for or against these policy choices, but rather to examine the market-driven impacts of salmon aquaculture on U.S. fishermen and consumers.<sup>9</sup>

**Figure 8.10. World salmon supply: U.S. & Foreign.**



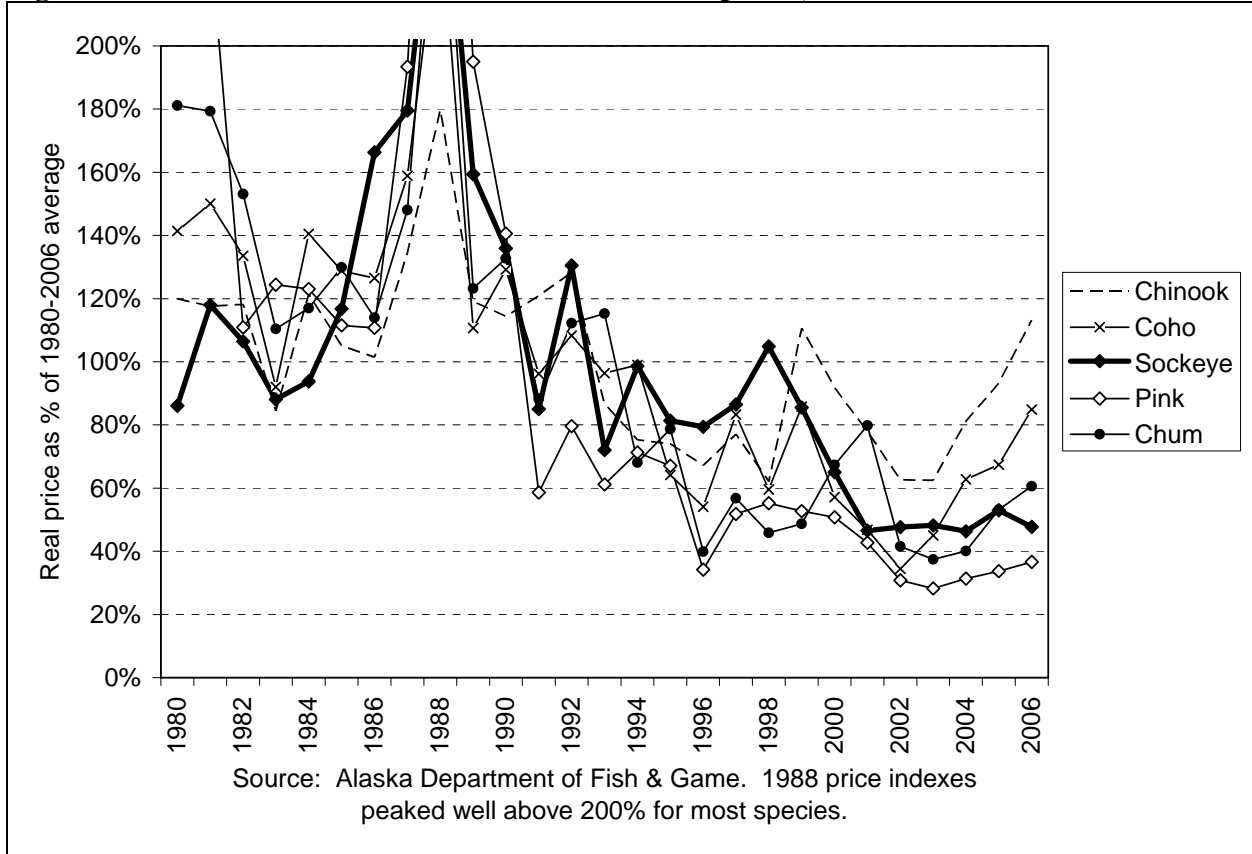
After peaking in the late 1980s, “ex-vessel” prices paid to Alaska fishermen for all five species of salmon fell dramatically over a 14-year period ending in 2002 (Figure 8.11). The most important cause of the decline in prices was competition from farmed salmon in the

<sup>8</sup>With farmed salmon we include trout farmed in marine pens, a product very similar to farmed salmon which competes directly with farmed and wild salmon.

<sup>9</sup>The following discussion is based on analysis in Knapp et al, *The Great Salmon Run: Competition Between Wild and Farmed Salmon* (2007).

Japanese, American and European markets for frozen and fresh salmon. Note however that farmed salmon was not the only cause of the decline in prices. Numerous other factors, including large wild salmon harvests, a recession in Japan, and declining consumer demand for canned salmon, also played a role. .

**Figure 8.11. Indexes of real Alaska salmon ex-vessel prices, 1980-2006.**



The decline in wild salmon prices, combined with a drop in returns of sockeye salmon (the most valuable species) caused an economic crisis in the wild salmon industry and great hardship for thousands of salmon fishermen and fishing communities. Fishermen’s revenues declined dramatically while their costs continued to rise. Values of salmon fishing permits and boats declined dramatically, and many fishermen quit fishing. Many Alaska salmon processing plants closed.

It is difficult to estimate precisely how much income U.S. salmon fishermen may have lost because of salmon aquaculture, partly because other factors have also affected salmon prices, and partly because lower harvests also contributed to the decline in income. Nevertheless, it is clear that U.S. salmon fishermen were significantly harmed by salmon aquaculture, as predicted by the above theoretical discussion.

But it is also clear that the cause of the decline in U.S. salmon fishermen’s income was not U.S. salmon farming, but rather salmon farming in foreign countries. The effects of salmon farming on U.S. fishermen’s prices occurred despite the fact that U.S. farmed salmon production

was only a tiny share of world production. Policy choices which restricted U.S. farmed salmon production did not protect U.S. fishermen from the market-drive effects of farmed salmon.

Nor is it likely that *any* U.S. policies could have protected U.S. salmon fishermen from the market-drive effects of salmon aquaculture. The most important fresh and frozen markets for Alaska salmon were in foreign countries—particularly Japan—rather than the United States (Table 8.8). Even if the United States had banned imports of farmed salmon, it would not have prevented the competition which Alaska sockeye salmon encountered in the Japanese salmon market from farmed Chilean and Norwegian salmon and trout. In a globalized seafood industry in which U.S. fishermen are heavily dependent upon export markets, it is impossible for U.S. fishermen to escape competition from farmed fish—regardless of U.S. policy towards aquaculture.

**Table 8.8. Estimated end-market shares for U.S. wild salmon production, 2000-2004.**

		Species					TOTAL
		Sockeye	Pink	Chum	Coho	Chinook	
Average annual harvest value (\$ millions)		\$123	\$40	\$36	\$18	\$14	\$232
% of average annual harvest value		53%	17%	16%	8%	6%	100%
Estimated end-market shares	US fresh & frozen markets	12%	4%	41%	41%	87%	17%
	Export fresh & frozen markets	53%	26%	52%	50%	13%	42%
	Canned markets	35%	70%	7%	9%	1%	40%
	Total	100%	100%	100%	100%	100%	100%
Farmers competing with U.S. fishermen		Mostly foreign	Mostly foreign	Mostly foreign	Mostly foreign	Mostly foreign	Mostly foreign
Consumers of U.S. fresh and frozen salmon competing with farmed salmon		Mostly foreign	Mostly foreign	US & foreign	US & foreign	Mostly US	US & foreign

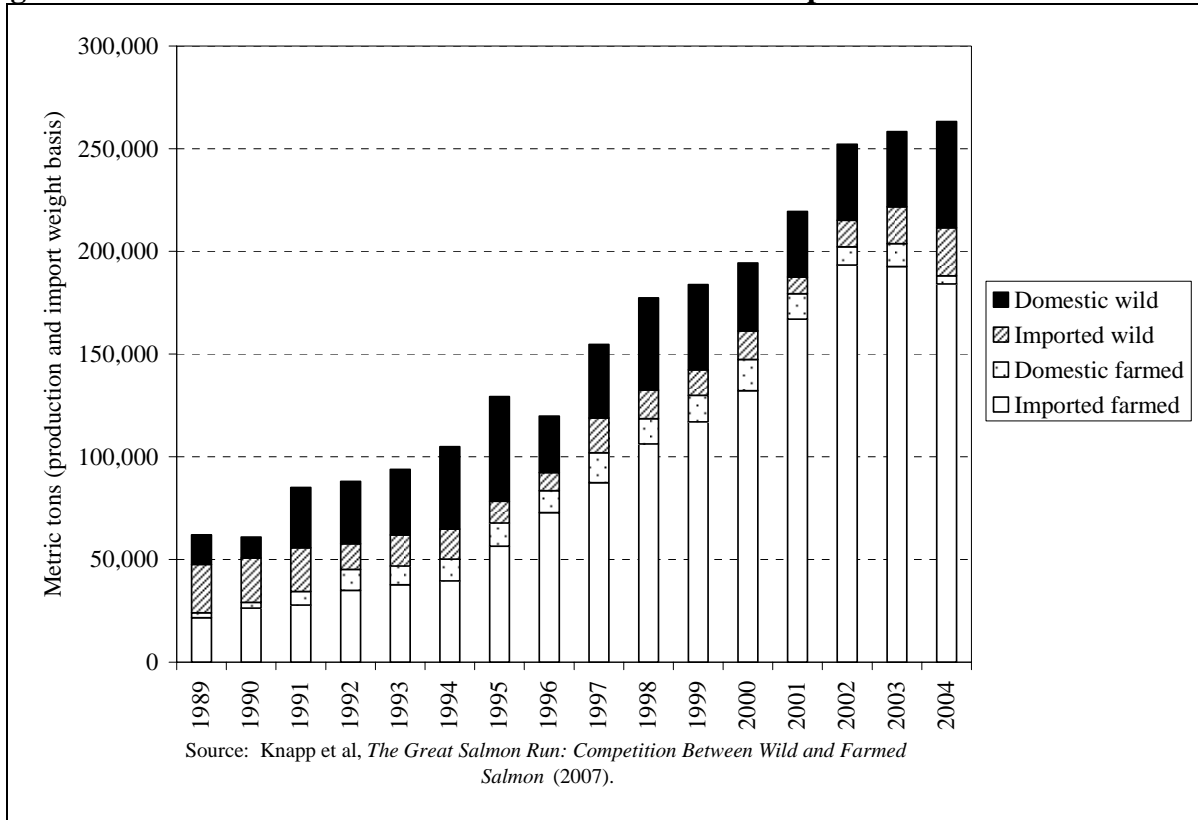
Source: Knapp et al (2007).

The dramatic growth in world salmon supply during the 1990s was reflected in a corresponding growth in U.S. consumption of salmon (Figure 8.12). Almost all of this growth in consumption was farmed salmon, almost all of which was imported, primarily from Canada and Chile.

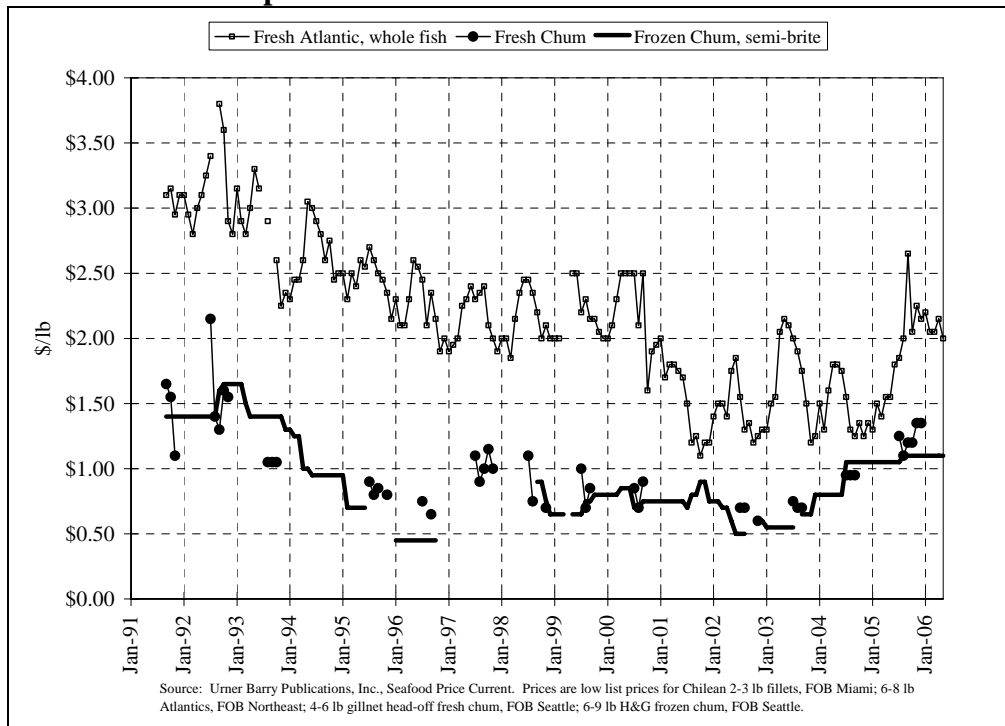
In the years prior to 2002, the increase in U.S. salmon consumption was accompanied and encouraged by a decline in U.S. prices for both farmed and wild salmon, as shown in Figures 8.13 and 8.14 for wholesale prices of farmed Atlantic salmon, wild chum salmon and wild chinook salmon. (Data showing long-term trends in retail prices are not available, partly because of the wide variation in retail products and retail stores).

United States consumers benefited from lower prices and from the availability of much larger volumes of salmon in the U.S. market. The rapid growth in consumption demonstrates that farmed salmon—which made salmon available to U.S. consumers in more places, over more of the year, and in convenient new product forms--was embraced by U.S. consumers.

**Figure 8.12. Estimated U.S. fresh and frozen salmon consumption: wild & farmed.**



**Figure 8.13. U.S. wholesale prices for farmed Atlantic salmon and wild chum salmon.**



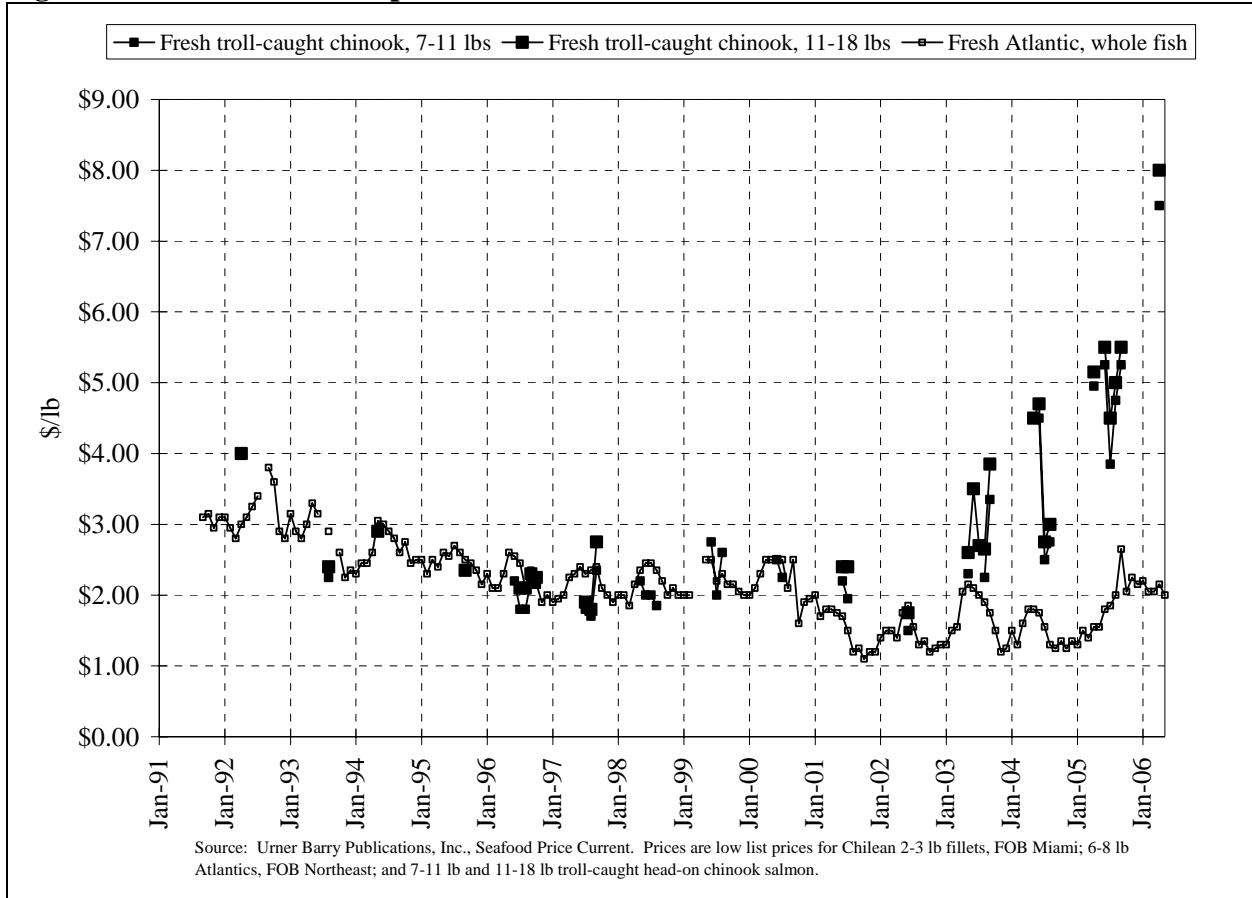


Falling wild salmon prices prior to 2002 illustrate the predicted “short run” negative effects of fish farming for fishermen discussed above. Note, however, that after 2002 U.S. wholesale prices for both farmed and wild salmon were *rising* (Figures 8.13 and 8.14). Similarly, “ex-vessel” prices paid to Alaska salmon fishermen were rising (Figure 8.11). Wholesale salmon prices also increased in the European Union, the world’s largest salmon market.

The fact that salmon prices rose after 2002 despite continued growth in world salmon supply during this period is a clear indicator that world demand for salmon was rising, consistent with the predicted “long run” effects of fish farming on demand discussed above.

Figure 8.14 also clearly demonstrates a growing price premium over farmed salmon for wild troll-caught chinook salmon, reflecting growing consumer differentiation between wild and farmed salmon. For this particularly high-quality species and product (which represents only a small share of total wild salmon supply), prices rebounded to levels of the 1980s. While this has not been the case for other salmon species, the increase in prices experienced since 2002 shows that the long-run effects of salmon aquaculture on wild salmon prices may not be as significant as the initial effects.

**Figure 8.14. U.S. Wholesale prices for farmed Atlantic salmon and wild chinook salmon.**



The strengthening of wild salmon prices since 2002 also reflects an improvement in both quality and marketing, as the wild salmon industry worked to compete more effectively with farmed salmon. This suggests that another effect of fish farming may be changes within wild fisheries to better address the demands of consumers. In effect, aquaculture brings competition to wild fisheries which had previously, like a monopoly, faced no competition. Just as competition for a monopoly tends to benefit consumers not only by lowering prices but also making the monopoly industry more responsive to consumers' demands, competition for wild fisheries may bring about changes which, although painful for fishermen, benefit not only consumers but ultimately the wild fishery as well.

### **References**

Knapp, G., C. Roheim and J. Anderson. 2007. *The Great Salmon Run: Competition Between Wild and Farmed Salmon*. Traffic North America. Washington D.C.: World Wildlife Fund.

Statistics Canada. 2005. *Aquaculture Statistics 2005*. Catalogue no. 23-222-XIE.

Statistics Norway. 2005. *Fish Farming 2003*. [www.ssb.no/nos\\_fiskeoppdrett](http://www.ssb.no/nos_fiskeoppdrett).

Statistics Norway. 2007. *Fish Farming 2005*. [www.ssb.no/nos\\_fiskeoppdrett](http://www.ssb.no/nos_fiskeoppdrett).

## CHAPTER 9

# Interactions Between Capture Fisheries and Aquaculture

Diego Valderrama and James Anderson

---

*The study of interactions between aquaculture and capture fisheries is important as they drive many of the changes that are currently transforming the seafood sector. A better understanding of these interactions brings important lessons for the improved management of wild fishery resources. This chapter explores in some detail the nature of these interactions and examines their implications for the future of both wild and farmed seafood sectors.*

### Introduction

As activities that take place in aquatic environments and rely upon aquatic resources, aquaculture and capture fisheries interact at many different levels. Some of these interactions are antagonistic, but in many cases synergistic relationships have also emerged. Interactions are determined to a large extent by both technological and institutional differences between the two sectors. Aquaculture normally involves an acceptance of ownership of products and production facilities, while capture fisheries exploit common property (De Silva et al., 2003). Capture fisheries typically utilize regulated open-access resources with human intervention occurring primarily at the harvesting stage. Aquaculture, in contrast, involves systems in which the grower has a large degree of control over both the cultured organism and the culturing environment. Practices such as culture-based or enhanced fisheries draw elements from both activities.

The largest influence of aquaculture on wild fisheries has probably occurred through international trade and the market. Aquaculture has: a) influenced prices negatively through increased supply and positively through the development of new markets (e.g., salmon and catfish); b) changed consumer behavior; c) accelerated globalization of the industry; d) increased concentration and vertical integration in the seafood sector; e) resulted in the introduction of new product forms; and f) significantly changed the way seafood providers conduct business.

The growth of aquaculture has stimulated the traditional wild fisheries sector to improve product quality in terms of freshness, consistency, handling, and processing. In some cases, aquaculture has provided incentives for fisheries management to become more efficient. This growth has also created a backlash of criticism from the wild fisheries sector (and environmental groups) through the media and, in several cases, has been met with increasingly restrictive international trade barriers (e.g., salmon, shrimp and catfish).

A second group of interactions is concerned with the flow of environmental impacts between the two sectors. These impacts, in turn, may have economic consequences for both aquaculture and wild capture fisheries. At this level, aquaculture has: a) directly influenced fish stocks through its use of wild fish stocks for inputs, such as feed; b) influenced fish stocks through intentional releases (salmon stock enhancement) or through unintentional escapes; c) displaced wild fish through its use of habitat and, in some cases, enhanced fisheries habitat (e.g., some oyster operations); and d) influenced and been influenced by wild fish stocks through transmission of diseases and parasites.

The study of interactions between aquaculture and capture fisheries is important as they drive many of the changes that are currently transforming the seafood sector. A better understanding of these interactions brings important lessons for the improved management of wild fishery resources. This chapter explores in some detail the nature of these interactions and examines their implications for the future of both wild and farmed seafood sectors.

### **Aquaculture, fisheries, markets and trade**

Whether aquaculture and fisheries behave as competitive or complementary activities is a research question that has received attention in recent times. Judgments regarding the positive or negative nature of these interrelations are likely to be influenced by the perspective of the different stakeholders: aquaculturists, fishermen, fisheries managers, traders, consumers, or environmentalists. It must be recognized, nevertheless, that aquacultural development has been stimulated by the overfishing of wild stocks, which has resulted in the inability of the wild sector to meet the growing demand for wholesome seafood products. Salmon farming emerged in the 1980s as wild stocks of Coho and Chinook salmon in North America dwindled and Atlantic salmon stocks were threatened in both America and Europe due to overfishing and loss of habitat. Growth in catfish and tilapia aquaculture has satisfied market demand in the whitefish complex as harvests of the wild product have decreased considerably. Falling supplies of wild groundfish have also stimulated commercial production of farm-raised cod in Norway. In each of these cases, the aquaculture sector has emerged to increase fish supplies, minimize environmental shocks, control fish stocks and growth rates, and manage to meet the demands of the market. Aquaculturists want to take control of production and marketing. They tend to do this through ownership, information and technology (Anderson, 2002).

The emerging aquaculture sector tends to be more forward looking, faster-growing, innovative, international, and control-oriented. It is shaping the future seafood sector through market, trade, and product interactions. Over the last few decades, aquaculture has:

- influenced prices through increased supply;
- changed consumer behavior resulting in the development of new markets;
- accelerated globalization of the industry;
- increased concentration and vertical integration in the seafood sector;
- resulted in the introduction of new product forms and improved quality and consistency;
- influenced the sector to become more forward-thinking and market driven;
- reduced price uncertainty and risk.

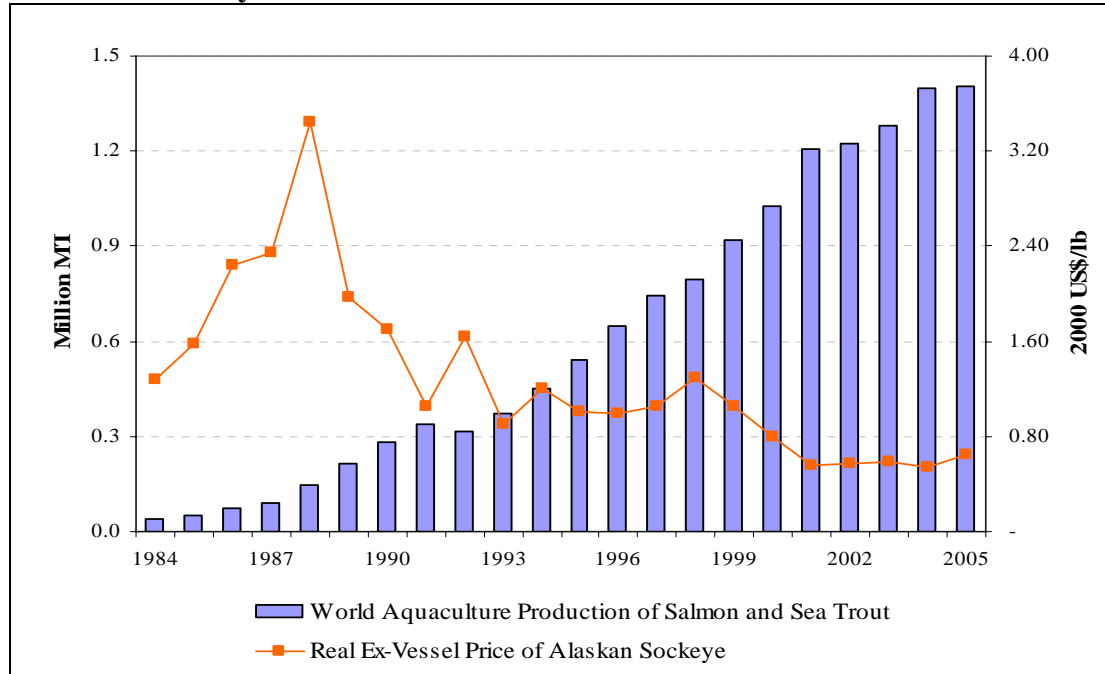
Some of these interactions are discussed more thoroughly in the following sections.

#### Price Interactions

The economic impacts of aquaculture on capture fisheries are more evident in the case of species such as shrimp and salmon, where markets for wild species were well established prior to the emergence of the global aquaculture sectors. The most visible impact concerns declines in the prices of wild-caught fish brought about in part by increased supplies of farmed fish, because farmed and wild products interact as close substitutes (Figures 9.1 and 9.2).

Figure 9.1 illustrates the evolution of real ex-vessel prices for Alaskan sockeye salmon during the last 20 years. Real prices consistently rose during the early and mid-1980s, but declined precipitously in 1989 and subsequent years. The fall in prices was closely related to record landings in the Alaska fisheries throughout the 1990s, as well as increased supplies from an emerging salmon aquaculture industry. The ex-vessel price in 2005 (in 2000 U.S. dollars) was only \$0.65/lb, equivalent to only 65% of the prevailing price in 1995, and barely 19% of the 1988 price.

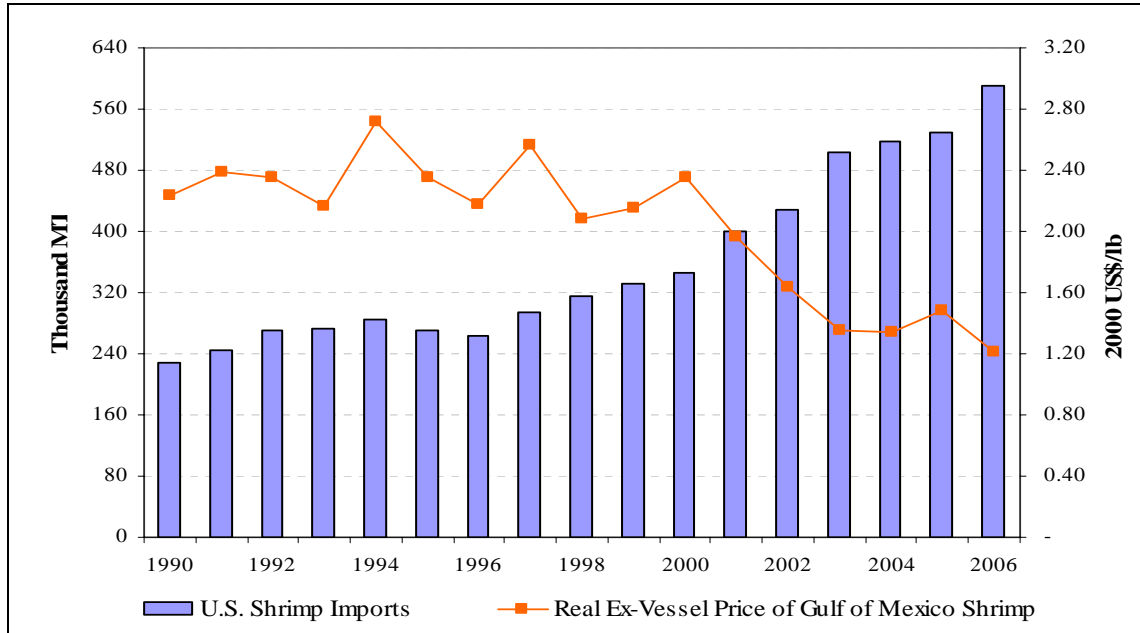
**Figure 9.1. Comparison of world salmon aquaculture production and real ex-vessel price of Alaskan sockeye salmon.**



Sources: FAO, 2007; ADF&G, 2007

Increasing shrimp imports to the U.S. market have had a similar impact on the ex-vessel prices of wild shrimp caught by the domestic fleet (Figure 9.2). Most of imported shrimp (around 70-80%) is produced in farms on the tropical regions of Asia and Latin America. The average ex-vessel price (2000 U.S. dollars) of the three most important domestic wild species (white, brown, and pink) oscillated around \$2.40/lb during the late 1980s and the 1990s. However, prices have fallen sharply since 2001. By 2006, the average real ex-vessel price was \$1.22/lb, around \$1.15 less than the real price in 2000. Domestic fishermen blamed increased imports of farmed shrimp for the faltering prices. Seeking relief from allegedly unfair trade practices, the U.S. fishing industry filed an antidumping suit against the six most important suppliers of shrimp to the U.S. market (Thailand, China, Vietnam, India, Brazil, and Ecuador) in December, 2003. In its final determination, the U.S. International Trade Commission ruled in favor of the domestic industry, and antidumping duties of various magnitudes were levied against the six subject countries (USITC, 2005).

**Figure 9.2. Comparison of U.S. shrimp imports and real ex-vessel price of domestic Gulf of Mexico (brown, pink, and white) shrimp. Approximately 70-80% of the shrimp imported into the U.S. are farm-raised.**



Source: USDC/NMFS Foreign Trade Database, 2007; USDC/NMFS Commercial Fishery Landings Database, 2007.

It should be noted that aquaculture production of salmon and shrimp has been increasing steadily, even in the face of declining prices. Guttormsen (2002) explains that such a phenomenon is evidence of productivity gains in the aquaculture sector, meaning that expansion has been possible due to the ability of farmers to substantially lower production costs. The difference in the structure of costs between aquaculture and wild fisheries has important implications. In the traditional fisheries, the primary costs are labor, fuel and fleet maintenance. In the aquaculture sector, the primary costs are feed and fingerlings. This distinction is important, as aquaculture has immense opportunities to reduce costs through genetics research and feed substitutions. In contrast, fisheries have less room for cost improvement unless a move is made towards more efficient management; e.g., rights-based fishing (Anderson, 2003). All of this comes down to a matter of better management, biotechnology and related factors. The most impressive achievements have been attained in salmon aquaculture, but there is still much room for improvement with regard to production of tilapia and other new species. This trend will enable aquaculture to continue recording gains in market share at the expense of wild-caught species.

While negative price interactions are generally more visible, some positive price influences between aquaculture and wild fisheries have also been observed. Positive interactions emerge when the aquacultured product is introduced into new markets and creates additional demand for both farmed and wild species. For example, prior to the advent of salmon farming in the 1980s, salmon consumption in the U.S. was limited seasonally and regionally - primarily to the Pacific coastal areas. The growth of aquaculture in Norway, Canada, and Chile led to consistent supplies of fresh, high-quality salmon in the untapped South and Midwest regions. The increased availability resulted in new demand for both farmed and wild salmon in these

regions. The case of catfish is similar. Prior to modern production in farms, catfish was generally regarded as a low-quality wild product with consumption restricted to the poor areas of the rural South. The consistent delivery of a high-quality product from catfish farms turned around this perception over a few decades, with concomitant increases in price. Nowadays, catfish is routinely included in the list of Top 10 seafoods in the U.S. (NFI 2007).

In addition to the price interactions, it has been suggested that aquaculture may contribute to the recovery of overexploited wild stocks, as reduced prices lead to lower fishing effort. These interactions were formally analyzed by Anderson (1985) and Ye and Beddington (1996). Anderson's analysis showed that the entry of aquaculture reduces effort and increases total supply from open-access fisheries while raising natural fish stocks. Because aquaculture enhances efficiency in the capture fishery while increasing availability of fish to consumers, aquaculture development is regarded by some as a much more effective management tool relative to traditional measures of effort control. In a related analysis, Green and Kahn (1997) found similar results and used them to argue for public subsidization of aquaculture.

#### *Econometric Models and Time Series Analyses*

A number of studies have examined market interactions between aquaculture and fisheries by estimating demand equations for a specific group of commodities and testing whether cross-price effects occur. The general idea is to probe the existence of an underlying marketplace constituted by a group of commodities consisting of both farmed and wild-caught species. The group of commodities competes in the same market because consumers may substitute goods. The cross-price effects estimated from the system of demand equations provide a measure of the degree of substitution among competing goods.

In the late 1980s and early 1990s, a number of empirical analyses of the international salmon market estimated demand functions for both wild-caught and farmed species. Herrmann, Mittelhammer and Lin attempted to describe the patterns of salmon trade between North America, the European Community (EC), Japan, and Norway through several econometric models (Herrmann, 1993; Herrmann et al., 1993; Lin et al., 1989; Herrmann and Lin, 1988; Lin and Herrmann, 1988). In general, these studies reported large income and own-price elasticities, consistent with the notion of salmon as a luxury food item previous to the revolution brought upon by salmon aquaculture. The cross-price elasticities between farmed Atlantic and wild Pacific species revealed a significant substitute relationship; however, the degree of these interactions varied widely among studies. The most recent of these analyses (Herrmann, 1993) reported an own-price elasticity of -1.76 for Norwegian farmed Atlantic salmon in the U.S. market, with an income elasticity of 1.69. The cross-price elasticity with respect to North American Pacific high-valued salmon (Chinook, Coho, and Sockeye) was estimated to be 0.72. This study was based on data from the period 1982-1991.

Although the econometric models of Herrmann and his collaborators established a connection between farmed and wild salmon in the world markets, they failed to capture the full extent of changes caused by the rapid development of aquaculture. Wessells and Anderson (1992) indicated that the demand curves estimated in these studies are actually capturing a series of demand shifts of a growing market. Because the supply of Norwegian farmed salmon grew at such a rapid pace during the 1980s, demand for the product expanded from exclusive, up-scale

restaurants to other restaurants and supermarkets. The aggregate elasticities estimated by Herrmann do not account for the fact that different sectors (retailing, restaurants) may have different demand elasticities, which were evolving during the study period due to demand shift and expansion into new markets.

With regard to shrimp, Keithly et al. (1993) conducted a comprehensive econometric analysis of trade flows in the world market using annual data from 1965 through 1989. Their analysis was based on an examination of the U.S. and Japanese shrimp imports markets in a simultaneous-equations framework. The model consisted of five structural equations: two of the equations defined import demand relationships for the U.S. and Japan; another two equations defined export supplies to the U.S. and Japan; and a fifth equation defined demand for U.S. warmwater shrimp, caught by the domestic fishing industry. The U.S. warmwater shrimp demand equation in the model specified the real U.S. dockside shrimp price to be negatively related to U.S. warmwater catch, U.S. beginning-of-the-year inventories, and U.S. imports. The level of U.S. imports (consisting primarily of aquacultured product) was determined endogenously in the model. Results indicated that U.S. warmwater catch and imports have similar impacts on dockside price because of their high degree of substitutability. A 10-million pound increase in imports was found to lead to a \$0.084 decline in real dockside shrimp price, with all other factors held constant.

Given the expected increase in world supply of farmed shrimp during the 1990s, Keithly et al. (1993) correctly anticipated that expanding imports of aquacultured shrimp would contribute to lower dockside and farm-gate prices of U.S. warmwater shrimp (wild and cultured). The authors also predicted that the U.S. fishing industry would respond to an increasing flow of imports by lobbying in favor of restrictive trade measures such as tariffs or quotas, in an attempt to increase prices. Keithly argued against such measures, as the common property nature of the Southeast shrimp fishery suggested that any increase in price would be followed by an expansion in shrimping effort. This expansion would drive industry profits, excluding opportunity costs, back toward zero.

In addition to estimating demand functions and cross-price elasticities, substitution relationships among two and more products can also be tested by examining the properties of the respective price-time series through cointegration techniques. The general idea is that, provided the products are substitutes for each other, prices will be integrated and will tend to move together. Thus, if the supply curve for farmed fish shifts out (meaning that the price of farmed fish falls) and there is a substitution effect between farmed and wild products, the demand schedule for wild fish shifts and the price will change in the same direction as the price of farmed fish. At most, the price of wild fish can shift by the same percentage as the price of farmed fish, making the relative price constant. When this occurs, it is said that the “Hypothesis of One Price” holds (Asche et al., 2001).

Most cointegration-analysis studies examining the price interactions between wild and farmed species have been conducted with respect to salmon. Results of these studies are consistent with previous demand analyses and indicate that different salmon species and product forms are close substitutes (e.g., Asche et al., 1999; Clayton and Gordon, 1999; Gordon et al., 1993). An important conclusion is that increased production of farmed salmon has had a



substantial impact on the markets and prices for wild Pacific salmon. Asche et al. (1999) attributed declining prices in the world salmon market throughout the 1990s to the remarkable increases in productivity in the farmed salmon industry. Similarly, Clayton and Gordon (1999) supported the existence of an equilibrium price system in the U.S. market for farmed Atlantic and wild Chinook and Coho salmon.

There is little evidence that farmed salmon competes with species other than wild salmon. In their analysis of the Spanish seafood market, Jaffry et al. (2000) concluded that salmon is at best only a weak substitute for tuna, hake, and whiting. In general, salmon does not seem to compete with the species constituting the global whitefish market (Asche et al., 2001). However, other emerging aquaculture species such as tilapia and catfish have made significant inroads in the whitefish market (Picchiatti, 1996; Barnett, 1990).

Similar analyses have also been conducted to examine price interactions between farmed and wild-caught shrimp. Béné et al. (2000) conducted a series of cointegration tests with data from the French market and concluded that the price series of the (farmed) black tiger shrimp and the (wild-caught) French Guyana (FG) brown shrimp were cointegrated, with the black tiger shrimp acting as a market leader for the FG shrimp product. Despite its perceived lower culinary quality, farmed shrimp emerged as the “leader” product in the French market over the last 15 years due to its consistent supply and year-round availability. The authors suggested that the only way for local FG exporters to eliminate the exogenous influence of the black tiger shrimp would be to “cut” the relationship that links the price of the FG product to that of the farmed shrimp. This could possibly be achieved by taking advantage of the superior culinary quality of the brown shrimp to create a niche market where the FG product could be supplied without having to compete against the farm-raised shrimp.

More recently, Vinuya (2007) used cointegration analysis to examine the degree of market integration in world shrimp markets. His results indicated a strong linkage among the Japanese, U.S., and European markets. The analysis concluded that the recent antidumping tariffs levied against the six major exporters to the U.S. market will have little long-term effect on domestic shrimp prices, as exporters not targeted by the antidumping tariffs realign their supplies from the other marketplaces (E.U. and Japan) towards the U.S. Recent empirical evidence confirm these findings.

#### *Changes in the Patterns of Seafood Consumption in the U.S.*

An examination of seafood consumption in the U.S. illustrates the influence of the aquaculture sector on seafood availability, changes in consumer behavior, and increasing concentration on fewer species. First, per-capita consumption of aquaculture species has increased remarkably over the last two decades (Table 9.1). In 1987, three “aquaculture” species—shrimp, catfish, and salmon—accounted for only 21% of U.S. consumption of seafood products. Per-capita consumption of wild-caught species such as cod, Alaskan pollock, and flatfish exceeded consumption of either catfish or salmon. By 2006, the ranking of the “Top Ten Seafoods” had shifted remarkably toward species of aquaculture origin. Shrimp, salmon, catfish, and tilapia accounted for 50% of the U.S. consumption of seafood. Salmon, in particular, recorded impressive gains: per-capita consumption rose by nearly 360% between 1987 and 2006, exceeding consumption of more traditional capture species such as cod, pollock, and flounder.

Tilapia has also made notable gains. Practically unknown in the U.S. market until the late 1990s, it became widely available in the last few years. By 2006, it was the fifth most consumed species, displacing competing species in the whitefish market segment such as cod and groundfish.

Another important trend is that seafood consumption in the U.S. is becoming concentrated on fewer species. The top five species accounted for 72% of consumption in 2006; in comparison, they accounted for only 56% of consumption just two decades ago. The top ten species comprised 71% of consumption in 1987; they now represent 90%.

The trends of falling prices and increasing concentration of consumption are explained by the fact that growing markets and growing trade will be secured by those who can consistently deliver a high-quality product at stable or declining costs. In the seafood sector, this is what aquaculture producers have been doing for the past few decades. It can also be argued that sector diversity in the future is going to come from the “sauce” (i.e.; the value-added component of the fish) and from image issues such as ecolabeling, rather than being created through the production of a large number of species (Anderson and Valderrama 2007). Thus, despite the fact that hundreds of different species are harvested - and will continue to be harvested - around the planet, in proportional terms more and more of the supply is going to be concentrated in fewer and fewer species. Likewise, more and more of the diversity is going to come from the marketers because, as they take control of and manage the fish, they can market it better and start selling additional attributes. By contrast, the traditional fisheries sector is going to experience many more difficulties in this category. Aquaculture operations tend to be managed for production and marketing control. Conversely, the wild sector is managed towards restricting access and harvesting the ‘right’ amount to meet conservation goals. However, they are still failing to manage for quality and the market; yet, it is clear that the sector that manages for these two factors will attain greater market success.

The specific cases of salmon and tilapia exemplify the points made earlier. Farmed salmon production already accounts for over 70% of world supply, while the capture sector’s harvest has remained relatively stable (Knapp et al., 2007). Regarding U.S. salmon imports, most of the growth in recent years has come in the form of boneless, skinless fillets produced primarily in nations with significant aquaculture industries. A natural consequence of having an industry where production systems are more highly controlled is that more value-added processing activities can occur. The industry is currently dominated by portion-control, value-added products. The recent negative media campaigns against salmon aquaculture appear to have had some limited impact on demand (an analysis of these developments is beyond the scope of this chapter). For the purposes of this discussion, the point that must be emphasized is that salmon aquaculture has moved forward and gained market share despite the negative media; yet there is still room for wild salmon in both the low-end (pink and chum salmon) and the specialty/premium (chinook, coho and sockeye) segments.

Tilapia also supports strong aquaculture industries in developing countries (Egypt, Philippines, Indonesia, and China). As observed previously with salmon, U.S. imports of tilapia are experiencing a shift from whole to processed forms. Tilapia is seen as a substitute for

flounder, snapper and all types of whitefish. In addition, tilapia is seen favorably by many environmental groups.

**Table 9.1. Per Capita Consumption of Seafood Species in the U.S. Species for which a Vast Majority of Supply Comes from Aquaculture are Shown in Bold Font.**

Ranking	1987	Pounds		2006	Pounds	Percent Change
1	Tuna	3.51		<b>Shrimp</b>	4.40	+92%
2	<b>Shrimp</b>	2.29		Canned tuna	2.90	-17%
3	Cod	1.68		<b>Salmon</b>	2.03	+359%
4	AK Pollock	0.88		Pollock	1.64	+86%
5	Flatfish	0.73		<b>Tilapia</b>	1.00	N/A
6	Clams	0.66		<b>Catfish</b>	0.97	+63%
7	<b>Catfish</b>	0.60		Crab	0.66	+101%
8	<b>Salmon</b>	0.44		Cod	0.51	-70%
9	Crab	0.33		Clams	0.44	-33%
10	Scallops	0.33		Scallops	0.31	-8%
	Other	4.76		Other	1.68	-65%
<b>Total</b>		<b>16.20</b>			<b>16.50</b>	<b>+2%</b>

Source: NFI (2007).

### Aquaculture and fisheries interactions through the environment

Aquaculture and fisheries interact in several ways in the aquatic ecosystem. For example:

- aquaculture can influence fish stocks through its use of wild fish stocks for inputs, such as feed, broodstock or juveniles;
- aquaculture and wild fish stocks can influence each other through disease transmission and other related interactions;
- aquaculture can influence wild fish stocks through intentional releases (e.g., salmon enhancement) or through unintentional escapes;

- aquaculture can displace wild fish through its use of habitat or, in some cases, it can enhance fisheries habitat (e.g, the infrastructure of oyster farms create oyster reefs).

A few examples will be mentioned to illustrate each of these interactions individually.

#### Use of Wild Fish Stocks as Inputs

Aquaculture can influence fish stocks through its use of wild fish stocks for inputs. One of the most controversial examples concerns the use of small pelagic fishes for fishmeal and fish oil. The growth of aquaculture, in particular the farming of carnivorous fishes, has had a direct impact on the demand for fishmeal and fish oil. Fishmeal prices have traditionally traded in a range of two to three times the price of soymeal; however, fishmeal has traded recently at levels more than six times the price of soymeal. The traditional relationship between fishmeal and soymeal has changed substantially. Empirical evidence indicates that the increased relative price of fishmeal and fish oil represents an important structural shift (Kristofferson and Anderson, 2006). If fisheries are well managed, this implies an opportunity for the wild fisheries sector to increase net revenue. On the other hand, if fisheries are poorly managed, this implies increased risk of overfishing. In either case, the increased relative price for fishmeal and fish oil presents an incentive for innovation. In the specific case of salmon aquaculture, this phenomenon has led to the rapid development of new feed formulations and declining feed conversion ratios.

Another way aquaculture uses wild fish stocks for inputs is when it utilizes wild juveniles for growout. For example, tuna farmers in Australia, Mexico and the Mediterranean capture wild juveniles to be fattened in aquaculture cage systems. At its beginnings, the modern farmed shrimp industry was heavily dependent on broodstock and post-larval shrimp from the wild fisheries. The farmed oyster and mussel industries depend heavily on wild seed. If not managed correctly, the extraction of inputs could have negative effects on wild fish stocks. However, positive effects are also possible: the use of wild seeds for oyster and mussel farming may actually help increase the stock of oysters and mussels by increasing survivability.

#### Issues Regarding Invasive Species and Two-way Transmission of Parasites and Diseases

Aquaculture and wild fisheries have influenced each other through the transmission of diseases and parasites. In addition, many cases of introduction of nonnative species have involved aquacultured organisms. Oysters provide a useful example in this regard (NRC 2004). In the U.S. East Coast, the oyster disease MSX was introduced from Asia (by means of a carrier agent not yet conclusively determined) and it contributed significantly to the decline of oysters, especially in Chesapeake Bay. Another oyster disease, Bonamiosis, was introduced into France by oysters imported from North America. This introduction contributed considerably to the rapid decline of the French oyster farming industry in the 1970s. In both cases, part of the solution involved the introduction of oysters from Asia which were naturally resistant to the disease. Today the French industry is dependent upon *Crassostrea gigas*, an oyster from Asia, and U.S. officials are considering introducing the farmed Asian oyster, *C. ariakensis*, into the Chesapeake Bay. In both cases, the unfortunate invasions of introduced diseases have resulted in the use of farmed nonnative organisms to mitigate the problem.

Despite media attention to concerns related to the introduction of nonnative species, this type of introduction is common. White shrimp (*Penaeus vannamei*) from South America have

been introduced into Asia because they are resistant to the White Spot disease and they are easier to grow than the native black tiger shrimp. Salmon have been introduced into Chile, New Zealand and Australia, and this introduction has resulted in substantial industries in these countries. The U.S. has introduced channel catfish (*Ictalurus punctatus*) into China. Tilapia, originally from Africa, has been introduced into nearly all tropical regions in the world.

#### Release of Individuals from Aquaculture Facilities

Aquaculture has also been used to replenish or enhance fisheries through purposeful release of juvenile or adult fish. For example, the Japanese chum salmon fishery is almost exclusively dependent upon hatchery-based salmon. In Alaska, approximately 40 percent of the state's salmon harvest is dependent upon hatchery-based fisheries (Knapp et al., 2007). However, although hatchery (aquaculture)-based capture fisheries may result in increased harvest, they also may facilitate inefficient harvest practices and create problems with genetic diversity and the integrity of truly wild stocks (Hilborn 1992).

#### Influences on Habitat

Aquaculture practices have had some extensive influence on habitat. For example, pioneering shrimp farms negatively impacted mangrove forests in tropical countries. In some locations, excessive finfish cage culture has resulted in the destruction of benthic habitat and created pollution. But there are also examples of positive aquaculture influence on habitat. The relocation of shrimp farms to zones above mangrove forests has paralleled increases in mangrove cover areas (Fast and Menasveta, 2003; Lutz, 2001). Oyster culture has contributed positively to reef development, which increases the diversity of fish in the area. Net pens also create habitat for marine species and act as fish aggregating devices. In a recent study, Rensel and Foster (2007) quantified the types and volumes of biocolonization at a commercial net-pen fish farm site in North Puget Sound in Washington State. The study showed that a typical fish pen system is populated by a diverse group of over 100 species of seaweeds or invertebrates, providing a locally important component of the food web.

Many of the conflicts concerning habitat use, siting of aquaculture facilities, and other environmental interactions can be addressed through integrated ecosystem-based management approaches to aquaculture development. McVey et al. (2006) and other authors (Dumbauld et al., 2006; Bridger, 2004; Cicin-Sain et al., 2001) offer valuable insights on how this could be achieved.

#### **Competition for ocean space**

Space-related conflicts between aquaculture and commercial fisheries have been reported in several locations around the world. For example, in the early 1990s, local fishermen from the west coast of Ireland perceived that the expansion of salmon farms resulted in an increasing number of restricted areas for fishing (Steins, 1997). The fishermen safeguarded access to their historical fishing grounds by forming a shellfish cooperative to secure aquaculture licenses. Similar conflicts have also been reported in Norway between aquaculture and commercial herring fisheries (Doksroed, 1996). In the U.S., the siting of an experimental aquaculture grow-out facility for sea scallops off the coast of Martha's Vineyard, Massachusetts, found strong

opposition from local commercial fishermen who argued that the proposed location would hamper lobster fishery activities (WSC, 1998).

Despite the potential for conflicts, adequate coastal zoning management can lead to the development of synergies between aquaculture and traditional fisheries. In areas with declining wild catches and increasingly restrictive fishery regulations, aquaculture production may help keep waterfronts, docks, processing facilities, and cold storage units operating. One of the most successful cases of integration has been reported in Florida, where inshore fishermen forced out of business through legislative action entered into hard clam aquaculture with relative success (Barnaby and Leavitt, 2001). Open-ocean aquaculture may also provide unique opportunities for commercial fishermen either as a new occupation or a business that could complement their fishing practices since they already own vessels and have the maritime skills and knowledge of local oceanic and weather conditions. In fact, the pioneering offshore operations in the U.S. (in Hawaii and Puerto Rico) were started by individuals with commercial fishing backgrounds (Rubino 2007).

## Conclusions

This major ideas presented in this chapter are summarized below.

- One of the most important incentives for aquaculture development came from the failure of wild fisheries to meet market demands.
- Aquaculture development has led to changes in fisheries:
  - through competition (supply).
  - by developing new technology (hatchery-based fisheries).
  - by example (quality control).
  - by creating new demand – both for inputs (fishmeal) and outputs (seafood).
- There will be increases in per-capita seafood consumption; however, consumption will be concentrated on fewer species, with diversity coming in the “sauce” and with labeling issues, such as organic production and ecolabeling.
- The growth of aquaculture parallels a shift in the market towards value-added products. Technology, innovations, better nutrition, and disease management will continue to reduce costs in aquaculture. Lower production costs will increase supply from aquaculture and hold prices down for all fish. The trend towards value-added creation will drive processing to countries where labor costs are low.
- The potential constraints for aquaculture development, in particular fishmeal usage, will largely be circumvented by new technology and substitution.
- Aquaculture will dominate the commodity markets, but there will be increasing opportunities for wild market products in the upper-end segments, especially the niche markets.

- In the long run, all significant commercial seafood supplies will come from one of three sources:
  - Fish farms/aquaculture;
  - Aquaculture-enhanced fisheries;
  - Fisheries that adopt efficient management systems. These systems should clearly define rights and responsibilities and be market and product-quality driven.
- Many of the space and habitat-related impacts of aquaculture development on traditional fisheries can be reduced or eliminated altogether through adequate siting and zoning of aquaculture areas. The principles of ecosystem-based management and Best Management Practices (BMPs) offer useful guidelines for future aquaculture development.
- As fishery regulations become overly restrictive in certain areas, reducing fishing times and employment in the fishing sector, a major challenge for fishermen is to figure out how to use aquaculture as a complement to their wild catch and/or income. There have been a few success stories of fishermen transitioning into the aquaculture sector. These stories can be used as case studies to help other fishing communities adjust to the changing regulatory and market conditions. Given the set of skills they already possess, some fishermen may be well positioned to participate in the emerging open-ocean aquaculture sector.

## References

Alaska Department of Fish & Game (ADF&G). 2007. Salmon fisheries in Alaska: catch, effort, and value information. [http://www.cf.adfg.state.ak.us/geninfo/finfish/salmon/salmon\\_catch.php](http://www.cf.adfg.state.ak.us/geninfo/finfish/salmon/salmon_catch.php)

Anderson, J.L. 2003. *The International Seafood Trade*. CRC Press LLC, Boca Raton, FL, and Woodhead Publishing Ltd., Cambridge, England.

Anderson, J.L. 2002. Aquaculture and the future: why fisheries economists should care. *Marine Resource Economics* 17:133-151.

Anderson, J.L. 1985. Market interactions between aquaculture and the common-property commercial fishery. *Marine Resource Economics* 2:1-24.

Anderson, J.L. and D. Valderrama. 2007. Trends in International Trade of Seafood Products. Invited Presentation to the FAO/UN Symposium "International Seafood Trade: Challenges and Opportunities". February 1-2, University of Akureyri, Akureyri, Iceland.

Asche, F., T. Bjørndal, and J.A. Young. 2001. Market interactions for aquaculture products. *Aquaculture Economics and Management* 5:303-318.

Asche, F., H. Bremnes, and C.R. Wessells. 1999. Product aggregation, market integration and relationships between prices: an application to world salmon markets. *American Journal of Agricultural Economics* 81:568-581.

- Barnaby, R. and D. Leavitt. 2001. Aquaculture - opportunity or threat to traditional capture fishermen? Aquaculture 2001: Book of Abstracts. Page 43. Annual Meeting of the World Aquaculture Society, Orlando, Florida.
- Barnett, J. 1990. A Review of the U.S. Farm-raised Catfish Industry and its Implications for Canadian Groundfish Exporters. Economic and Commercial Analysis Report No. 52. Department of Fisheries and Oceans, Ottawa, Ontario, Canada.
- Béné, C., M. Cadren, and F. Lantz. 2000. Impact of cultured shrimp industry on wild shrimp fisheries: analysis of price determination mechanisms and market dynamics. *Agricultural Economics* 23:55-68.
- Bridger, C.J. 2004. Efforts to Develop a Responsible Offshore Aquaculture Industry in the Gulf of Mexico: A Compendium of Offshore Aquaculture Consortium Research. Mississippi-Alabama Sea Grant Consortium, Ocean Springs, MS.
- Cicin-Sain, B., S.M. Bunsick, R. DeVoe, T. Eichenberg, J. Ewart, H. Halvorson, R.W. Knecht, R. Rheault. 2001. Proposed policy framework for offshore aquaculture in the United States. Open Ocean Aquaculture IV Symposium: Program and Abstracts. Page 41. Mississippi-Alabama Sea Grant Consortium, Ocean Springs, MS.
- Clayton, P.L. and D.V. Gordon. 1999. From Atlantic to Pacific: price links in the U.S. wild and farmed salmon market. *Aquaculture Economics and Management* 3:93-104.
- De Silva, S.S., J. Moehl, B. Satia, D. Bartley, and R. Subasinghe. 2003. Inland fisheries and aquaculture: A synergy for sustainable food fish production. Pages 37-45 in Review of the State of World Aquaculture. FAO Fisheries Circular No. 886 (Revision 2). FAO Inland Water Resources and Aquaculture Service, Rome, Italy.  
[http://www.fao.org/documents/show\\_cdr.asp?url\\_file=/DOCREP/005/Y4490E/Y4490E00.HTM](http://www.fao.org/documents/show_cdr.asp?url_file=/DOCREP/005/Y4490E/Y4490E00.HTM)
- Doksroed, T. 1996. Short history of coastal zone planning in Norway, with emphasis on the municipality of Vega. Pages 35-40 in Reconciling Pressures on the Coastal Zone: Fisheries and Aquaculture. Organization for Economic Cooperation and Development, Paris, France.
- Dumbauld, B.R., J. Ruesink, and M. Wecher. 2006. Oyster aquaculture in a Pacific Northwest (USA) estuary: A plea for taking a landscape-ecosystem perspective. *Journal of Shellfish Research* 25(2):724.
- Fast, A.W. and P. Menasveta. 2003. Mangrove forest recovery in Thailand. *World Aquaculture* 34(3):6-9.
- Food and Agriculture Organization (FAO). 2007. *FISHSTAT Plus: Universal Software for Fishery Statistical Time Series*. FAO Fisheries Department Statistical Databases and Software. Rome, Italy. <http://www.fao.org/fi/statist/FISOFT/FISHPLUS.asp>



- Gordon, D.V., K.G. Salvanes, and F. Atkins. 1993. A fish is a fish is a fish: testing for market linkage on the Paris fish market. *Marine Resource Economics* 8:331-343.
- Green, T.G. and J.R. Kahn. 1997. The myth of sustainability in managed wild fisheries: the economic case for aquaculture subsidies. Pages 437-442 in D.A. Hancock, D.C. Smith, A. Grant, and J.P. Buemer (eds). *Developing and Sustaining World Fisheries Resources: The State of Science and Management*. Commonwealth Scientific and Industrial Research Organisation, Brisbane, Australia.
- Guttormsen, A.G. 2002. Input factor substitutability in salmon aquaculture. *Marine Resource Economics* 17:91-102.
- Herrmann, M. 1993. Using an international econometric model to forecast Alaska salmon revenues. *Marine Resource Economics* 8:249-271.
- Herrmann, M. and B.-H. Lin. 1988. The demand and supply of Norwegian Atlantic salmon in the United States and the European Community. *Canadian Journal of Agricultural Economics* 36:459-471.
- Herrmann, M.L., R.C. Mittelhammer, and B.-H. Lin. 1993. Import demands for Norwegian farmed Atlantic salmon and wild Pacific salmon in North America, Japan and the EC. *Canadian Journal of Agricultural Economics* 41:111-125.
- Hilborn, R. 1992. Hatcheries and the future of salmon in the Northwest. *Fisheries* 17:5-8.
- Jaffry, S., S. Pascoe, G. Taylor, and U. Zabala. 2000. Price interactions between salmon and wild-caught fish species on the Spanish market. *Aquaculture Economics and Management* 4:157-167.
- Keithly, W.R., K.J. Roberts, and J.M. Ward. 1993. Effects of shrimp aquaculture on the U.S. market: An econometric analysis. Pages 125-156 in U. Hatch and H. Kinnucan (Editors). *Aquaculture: Models and Economics*. Boulder and Oxford: Westview Press.
- Knapp, G., C.A. Roheim, and J.L. Anderson. 2007. *The Great Salmon Run: Competition between Wild and Farmed Salmon*. Traffic North America. World Wildlife Fund, Washington, DC.
- Kristofersson, D. and J.L. Anderson. 2006. Is there a relationship between fisheries and farming? Interdependence of fisheries, animal production and aquaculture. *Marine Policy* 30:721-725.
- Lin, B.-H. and M. Herrmann. 1988. *An Econometric Analysis of Atlantic Salmon Markets in the United States and France*. Alaska Sea Grant Report 88-5. University of Alaska, Fairbanks, Alaska.

- Lin, B.H., M. Herrmann, T. Lin and R.C. Mittelhammer. 1989. Forecasting the price of farmed Atlantic salmon: an integrated econometric and time series approach. *Agribusiness* 5:477-488.
- Lutz, C.G. 2001. Responsible shrimp farming: a Honduran example. *Aquaculture Magazine* 27(6):34-40.
- McVey, J.P., C.-S. Lee, and P.J. O'Bryen, eds. 2006. *Aquaculture and Ecosystems: An Integrated Coastal and Ocean Management Approach*. The World Aquaculture Society, Baton Rouge, LA.
- National Fisheries Institute (NFI). 2007. *Top 10 U.S. Consumption of Seafood by Species Chart*. National Fisheries Institute, McLean, Virginia, USA.  
[http://www.aboutseafood.com/media/top\\_10.cfm](http://www.aboutseafood.com/media/top_10.cfm)
- National Research Council (NRC). 2004. *Nonnative Oysters in the Chesapeake Bay*. National Academy of Sciences Press, Washington, DC.
- Picchietti, M. 1996. Tilapia marketing maturity. *Aquaculture Magazine* 22(5):19-26.
- Rensel, J.E. and J.R.M. Forster. 2007. *Beneficial Environmental Effects of Marine Finfish Mariculture*. Final Report for NOAA National Marine Aquaculture Initiative Award #NAO40AR4170130. NOAA National Marine Fisheries Service, National Sea Grant College Program, Office of Oceanic and Atmospheric Research, Washington, DC.
- Rubino, M. 2007. NOAA Aquaculture Program. Personal Communication.
- Steins, N.A. 1997. The "Black Box" in Collective Action Research: Incentives from Outside the Management System (A Case Study of an Irish Aquaculture Cooperative). Working paper in Coastal Zone Management No. 22. Centre for Coastal Zone Management, University of Portsmouth, Portsmouth, UK.
- United States Department of Commerce / National Marine Fisheries Service (USDC/NMFS). 2007. Commercial Fishery Landings Database. <http://www.st.nmfs.gov/st1/commercial/>
- United States Department of Commerce / National Marine Fisheries Service (USDC/NMFS). 2007. U.S. Foreign Trade Database. <http://www.st.nmfs.gov/st1/trade/index.html>
- United States International Trade Commission (USITC). 2005. *Certain Frozen or Canned Warmwater Shrimp and Prawns from Brazil, China, Equador, India, Thailand, and Vietnam*. Investigations Nos. 731-TA-1063-1068 (Final). Publication 3748, U.S. International Trade Commission, Washington, DC.
- Vinuya, F.D. 2007. Testing for market integration and the Law of One Price in world shrimp markets. *Aquaculture Economics and Management* 11:243-265.

Wessells, C.R. and J.L. Anderson. 1992. Innovations and progress in seafood demand and market analysis. *Marine Resource Economics* 7:209-228.

Westport Scalloping Corporation (WSC). 1998. *Sea Scallop Enhancement and Sustainable Harvesting: The Seastead Project*. Final Report for NOAA Award No. NA66FD0027. Coonamessett Farm, North Falmouth, MA.

Ye, Y. and J.R. Beddington. 1996. Bioeconomic interactions between the capture fishery and aquaculture. *Marine Resource Economics* 11:105-123.

*This page intentionally left blank.*

# CHAPTER 10

## Current Status of Aquaculture in the United States

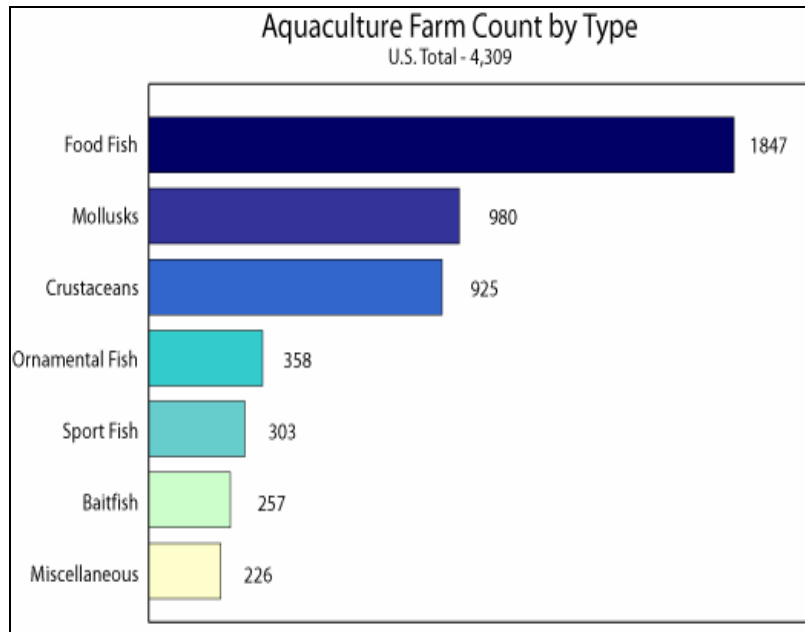
John Forster and Colin Nash

*This chapter outlines the current variety of species, technologies, methods, and places associated with aquaculture in the United States. The chapter focuses on six major species groups (catfish, salmon, shellfish, trout, tilapia, and public sector stocking) to illustrate the breadth of aquaculture activities.*

### U.S. aquaculture scope and diversity

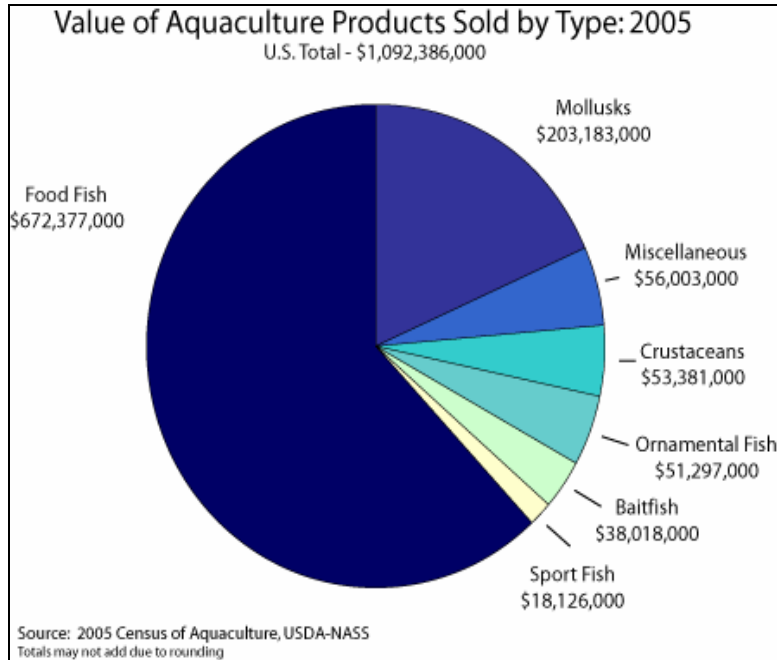
Private sector aquaculture in the United States is diverse, vibrant, and technically innovative, though production falls far short of what is needed by the Nation's markets. Aquatic farmers grow a wide variety of fish and shellfish species in fresh and salt water and do so in all regions of the country. This is illustrated in Figures 10.1 to 10.4 and Table 10.1 below.

**Figure 10.1. Aquaculture farm count by type.**



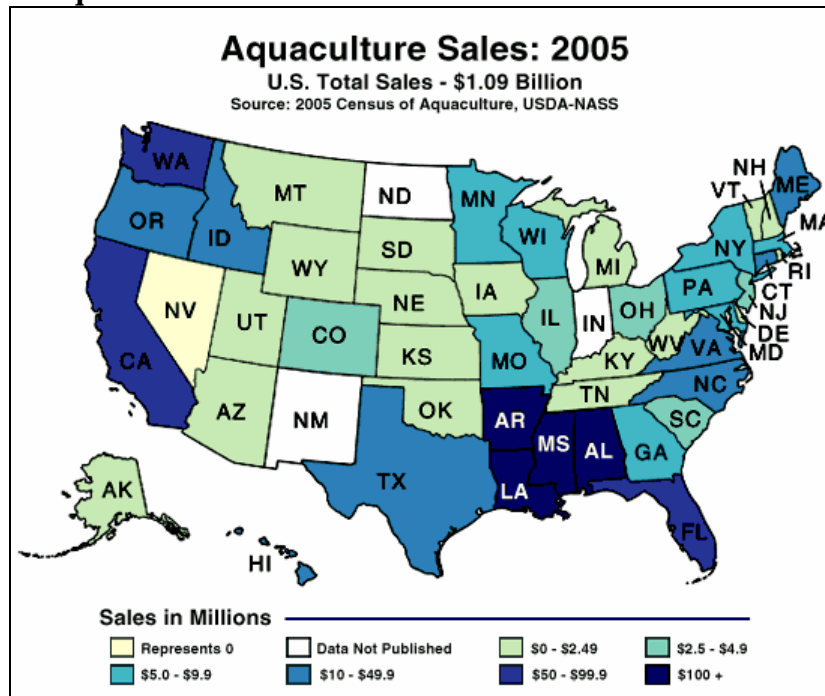
Source: United States Department of Agriculture

**Figure 10.2. Value of aquaculture products sold by type in 2005.**



Source: United States Department of Agriculture

**Figure 10.3. U.S. Aquaculture sales in 2005.**



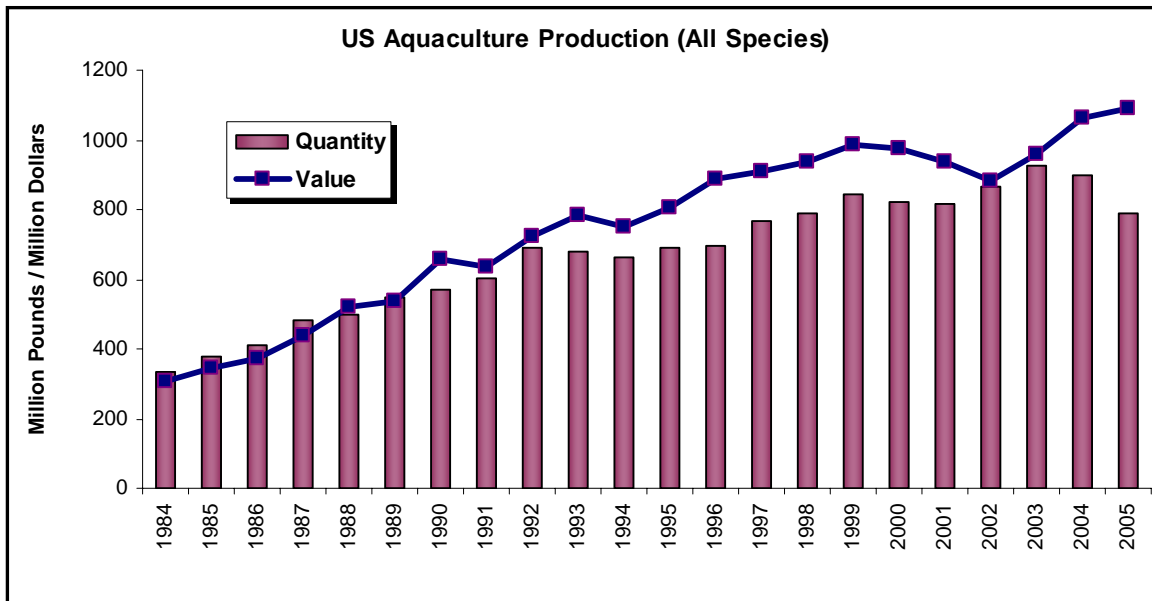
Source: United States Department of Agriculture

**Table 10.1. Aquaculture Statistics to show the weight of production of different categories in 2005.**

Species	Thousand pounds	Metric tons	Thousand dollars
<b>Finfish</b>			
<i>Baitfish</i>	NA	NA	38,018
<i>Catfish</i>	607,933	275,757	429,245
<i>Salmon</i>	20,726	9,401	37,439
<i>Striped bass</i>	10,970	4,976	27,655
<i>Tilapia</i>	17,203	7,803	29,620
<i>Trout</i>	60,636	27,504	65,469
<b>Shellfish:</b>			
<i>Clams</i>	12,564	5,699	72,783
<i>Crawfish</i>	35,933	16,299	21,143
<i>Mussels</i>	962	436	4,990
<i>Oysters</i>	13,711	6,219	92,602
<i>Shrimp</i>	8,037	3,646	18,684
<b>Miscellaneous</b>	NA	NA	254,738
<b>Totals</b>	<b>788,675</b>	<b>357,741</b>	<b>1,092,386</b>

Source NMFS, 2007

**Figure 10.4. Growth of the U.S. aquaculture industry.**



Source: NMFS, 2007

Aquaculture for food is by far the dominant sector of the industry. If production of those products sold for food, namely food fish, mollusks and crustaceans are added together, their total value in 2005 was \$929 million, 85% of all private sector aquaculture. This does not imply that other sectors are not important. Ornamental fish aquaculture, for example, provides the added value of relieving pressure on natural fish populations that might otherwise be targeted for this trade. The economic multiplier that might be applied to a kilo of sport fish for recreational

stocking is almost certainly higher than that applicable to a kilo of food fish; and this industry also helps to relieve pressure on natural populations. In fact, conservation aquaculture for replenishment and restoration of wild fish populations is a branch of the business that may see substantial expansion in the years ahead.

However, there is another part of the national aquaculture effort that is not represented in these figures. This is public sector hatchery production, which includes federal, state, tribal and private non profit hatcheries for species such as salmon, trout, bass, crappie and other recreational fish and which are to be found in all parts of the country. These hatcheries produce juveniles for stocking public fresh and marine waters contributing substantially to the Nation's commercial and recreational seafood harvest and representing a large investment in aquaculture facilities. For example, there are almost 400 salmon hatcheries on the West Coast that release about 1.7 billion juvenile salmon per year into the Pacific Ocean,<sup>1</sup> which, once they return as adults, support commercial and recreational fisheries throughout the region.

In this respect, aquaculture is different from most other business activities in the U.S. in that there is a large public as well as a private sector. Statistics on the overall scope, production and value of this public sector have not been the subject of a census as they have in private aquaculture, but this does not mean that public aquaculture is not important or that it should be omitted from a general overview of the US aquaculture industry. Hatcheries use exactly the same methods as are used in private aquaculture and, importantly, also use resources of water and land that might otherwise be available for private aquaculture development. Thus, details about their scope and contribution to the national aquaculture effort are included in section 6 below.

### **Farming of the principal species and species groups in the United States**

To provide an overview of the breadth and diversity of methods used in aquaculture, descriptions are given below of the farming of each of the top species or species groups in the U.S. Each of them uses different methods of production and therefore these descriptions provide a good general overview of the nature and scope of the entire industry. They include:

1. Channel catfish – farmed in ponds
2. Atlantic salmon – farmed in floating net pens
3. Bivalve shellfish (oysters, clams and mussels) – mostly farmed in littoral or shallow sub-littoral areas
4. Rainbow trout – farmed in flowing fresh water in raceways or tanks
5. Tilapia – farmed in recirculating aquaculture systems (RAS)
6. Public sector aquaculture

#### 1. Pond farming of Channel catfish

Catfish are farmed almost entirely in structured ponds filled by water pumped from aquifers or by natural runoff. Several other species such as shrimp, crawfish and baitfish are also farmed in the same way but catfish production is by far the dominant activity in the United States and is therefore the focus of this description.

---

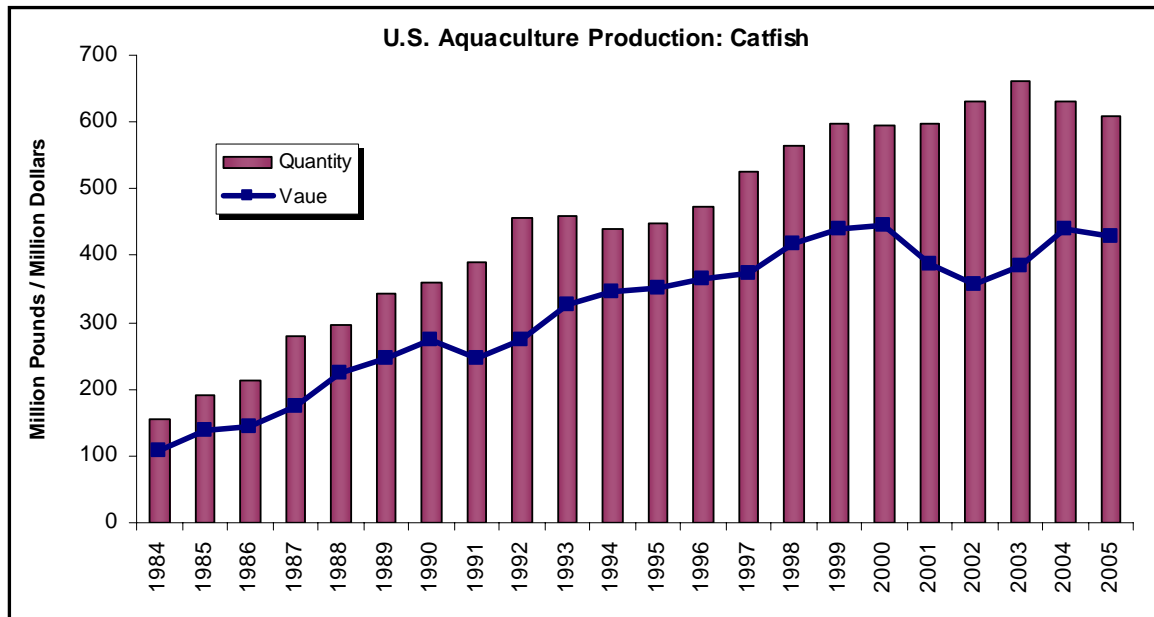
<sup>1</sup> White (2005 gives a figure of 1.4 billion for Alaska. Bartlett (2006) gives a figure of 300,000 for hatcheries in Washington. Oregon and California.



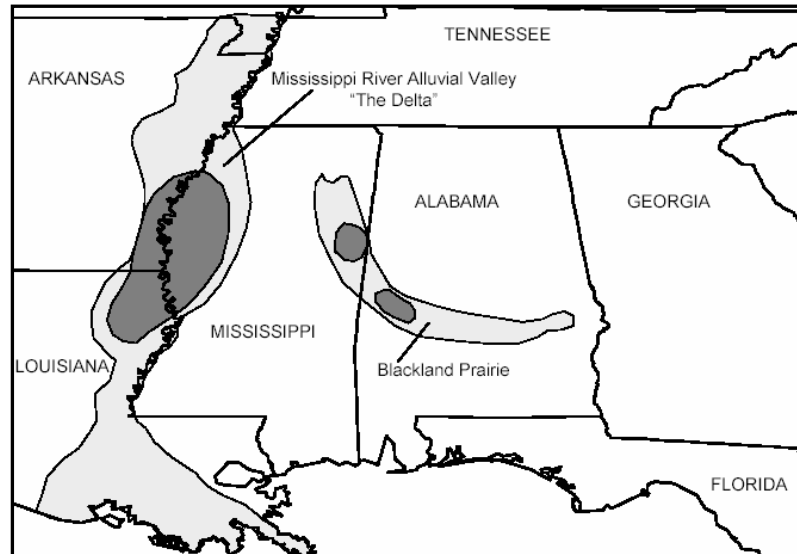
Almost all catfish production in the United States is located in southern states, where the climate provides adequate water temperatures for growth, and where the soil and elevation are suitable for pond construction (Figure 10.6). Harvey (2006) reported over 170,000 acres of ponds were operating in the country in March 2006. Much of this area was farmland, converted when landowners and farmers decided that catfish production would be more profitable than traditional agricultural crops. According to Tucker et al. (2004), this combination of climate, soils, available farmland, willing farmers, and the availability of a species of fish well-suited to farming represents a complex of conditions not easily replicated.

Channel catfish farming developed rapidly from 1980 to 2003 (Figure 10.5) and has become the largest sector of the national aquaculture industry. The basis for this growth involved complex interactions between biology, sociology, and economics, which all came together in the South Central and Southeast part of the US (Tucker et al., 2004).

**Figure 10.5. U.S. farmed catfish production and value.**



Source: NMFS, 2007

**Figure 10.6. Major U.S. catfish farming areas.**

Source: Tucker et al., 2004

Catfish farming has had a major economic impact on those areas in which it is practiced (Box 10.1). With capital investment of \$642 million, the catfish farming industry in Mississippi employs over 7,000 people in jobs directly related to production (Dean and Hanson 2003). Further, by using locally produced agricultural raw materials as ingredients in feed, catfish farmers add value to national agricultural commodities in the same way that producers of poultry, hogs, and beef add value. Catfish production has declined substantially during the past four years due to increased production costs (feed and fuel) and competition from catfish substitute species from Asia. 2008 U.S. catfish production is projected to be between 470 - 480 million pounds, down from a high of 630 million pounds in 2004 (NMFS 2007, Haley, 2008).

In recent years U.S. catfish farmers have experienced fierce competition from overseas fish farmers that produce fish similar to catfish, mostly “basa”, farmed in Vietnam and Tilapia, which is farmed in many tropical and sub-tropical countries. According to Harvey (2006), pond acreages have declined for four years in a row and, although there is potential to increase capacity, imports of competing products have held prices in check, while the cost of production has increased steadily with inflation and rising costs of feed. Recent trends in catfish processing volumes and prices are shown in Figure 10.7 while historical trends in production cost versus price are shown in Figure 10.8.

**Box 10.1. Summary of catfish industry facts.**

***Catfish Facts***

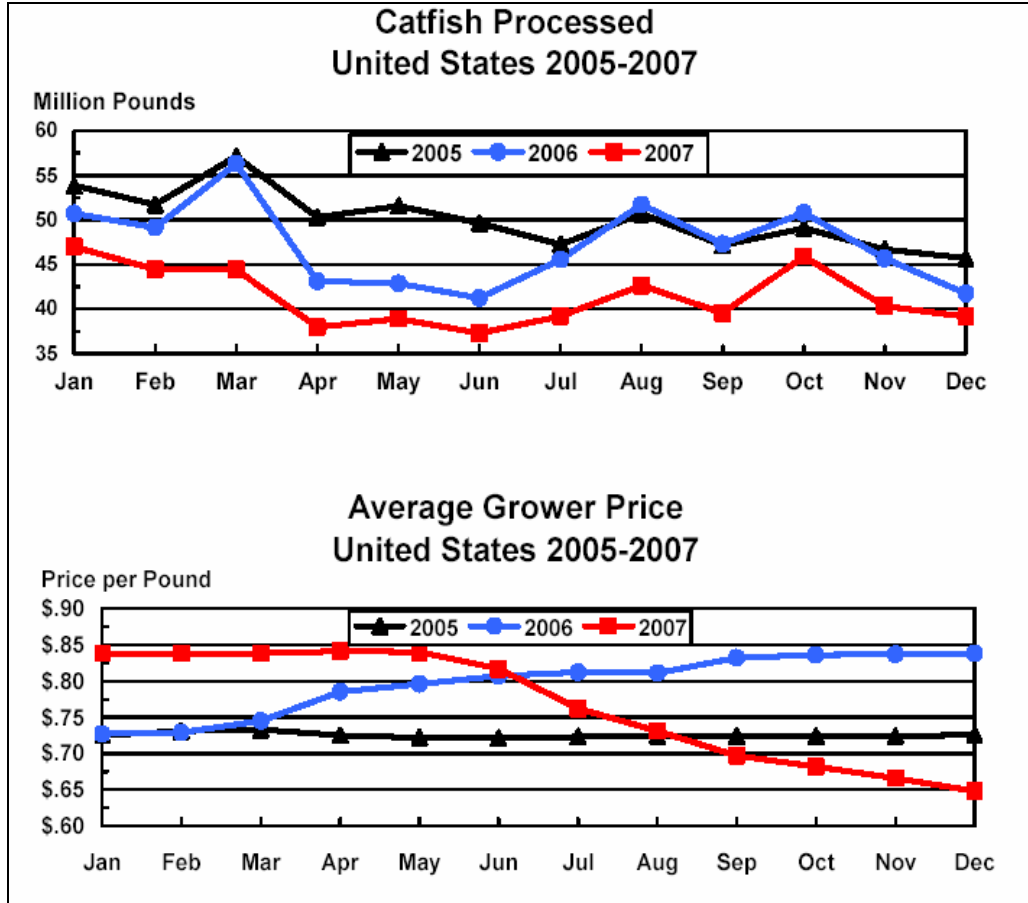
- Mississippi farmers sold 381 million pounds of farm-raised catfish to processing plants in 2001. This was around 64 percent of the total farm-raised catfish processed in the United States.
- There are more than 111,000 acres of catfish ponds in Mississippi. This is 177 square miles of ponds. If this were one pond, it would be a mile wide, and stretch along I-20 from the Alabama-Mississippi border to the Mississippi River.
- Mississippi catfish were fed more than 950 million pounds of feed in 2001. This could be hauled in a train of 4,950 96-ton hopper cars or a caravan of 19,800 18-wheel 24-ton feed trucks. At least 4 acres of grain crops are needed to support one foodsize fish acre.
- As shown in the table below, the Mississippi catfish industry employs more than 3,000 people on catfish farms, more than 3,600 workers in processing plants, and 330 in feed mills. Total payroll exceeds \$102 million, and total industry investments exceed \$600 million.
- The modern catfish industry originated in the Mississippi Delta in the late 1960's and early 1970's by farmers who were seeking an alternative to low-priced tow crops on clay-based soils.
- Mississippi's farm-raised catfish industry is a model world-class commercial aquaculture industry that is profitable, sustainable, and environmentally sound.

Direct Impact of the Catfish Industry in Mississippi				
Sector	Number of jobs	Payroll \$(Millions)	Sector Revenues* \$(Millions)	Investments \$(Millions)
Feed	330	8	150	95
Farming	3,000	37	260	397
Processing	3,671	57	435	200
<b>Total</b>	<b>7,001</b>	<b>102</b>	<b>845</b>	<b>642</b>

\* includes payroll from payroll column.

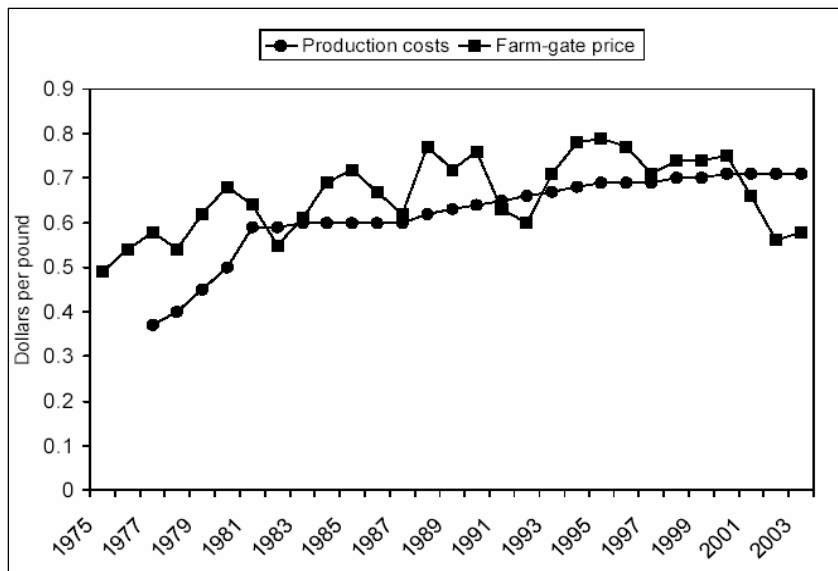
Source: Dean and Hanson, 2003

**Figure 10.7. Amount processed and average grower price of catfish in the United States, 2005-2007.**



Source: NASS, 2008.

**Figure 10.8. Cost of production and farm gate price for catfish to illustrate the cyclical nature of the industry.**



Source: Tucker et al., 2004

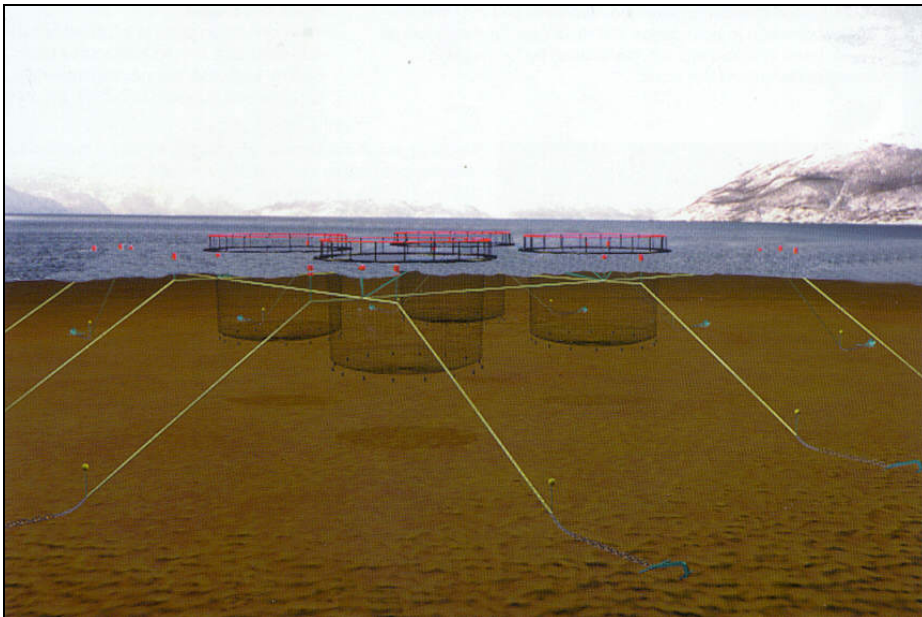
## 2. Net pen farming of Atlantic salmon

Salmon are farmed commercially in only two areas of the U.S.: Maine and Washington. The industries in these states represent less than 2% of a much larger global business that has developed quickly in the last 20 years. Global production of farmed Atlantic salmon in 2007 is estimated to have been 1.4 million mt of which the US imported about 300,000 mt (Seafood Intelligence, 2008).

Salmon are farmed in a two-stage process. First is the production of juvenile salmon, called ‘smolts’, in fresh water hatcheries. Second is the grow-out of these fish to market size in seawater cages or net pens. The freshwater stage is similar in many respects to the farming of rainbow trout and production of salmon juveniles for enhancement (Section 6 of this chapter). The hatcheries employ a flowing water culture method using raceways, or circular tanks, to raise newly hatched salmon ‘alevins’ through the early part of their life until they are ready as smolts to go to saltwater. The source of water can be a lake, stream, spring, or well with typical flows required being in the order of two to five million gallons per day.

The operating principle of net-pen farming is that net-pen containers, or cages, are suspended from floating collars and held in shape by weights attached to the bottom of the net (Figure 10.9). Water exchange then occurs within the net pen due to tide and wind driven water currents. The principle can be applied to many species of marine fish and other species that are grown in net pens in the United States, but on a much lesser scale than Atlantic salmon, including Pacific threadfin, white sea bass and yellowtail jack.

**Figure 10.9. Diagram of a simple net pen that can be used for salmon and many other fish species.**



Atlantic salmon have been farmed in Maine and Washington since the mid-1980s after attempts to farm Pacific Coho salmon in Washington during the 1970s and early 1980s came to an end. At that time, it was realized that Atlantic salmon were more suitable for farming because they are relatively easy to handle, grow well under culture conditions, have a relatively high commercial value and adapt well to farming conditions outside their native range (Knapp et al, 2007).

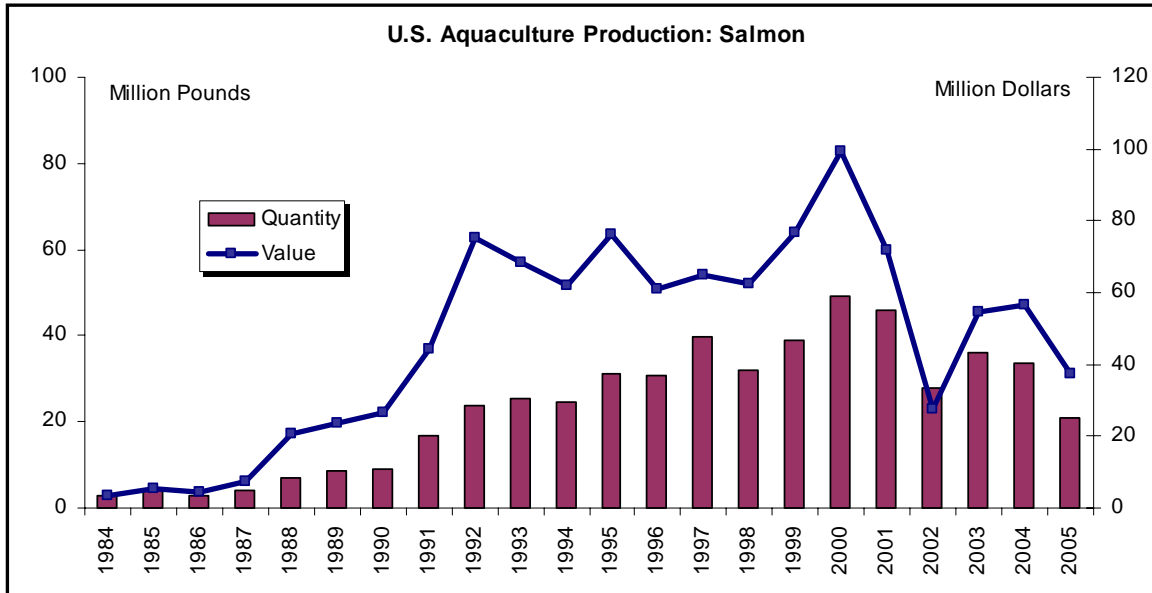
In 2005 (see Table 10.2), total US production of Atlantic salmon was 9,401 metric tons, with a value of \$37.4 million. However, as shown in Table 10.2 and Figure 10.10, both production and value were higher in previous years. These changes are due in part to globally driven swings in farmed salmon prices, 2002 being a particularly difficult year (Table 10.2), and in part to the fact that the industry in Maine suffered from the disease Infectious Salmon Anemia (ISA) between 2001 -2003. Even though ISA is now largely controlled, it still limits overall production volume.

**Table 10.2. Production and sales of US farmed salmon 2000 – 2005.**

Year	MT produced (x1,000)	Sales	Av price per kg
2000	22,395	99,208	\$4.43
2001	20,769	72,019	\$3.47
2002	12,734	27,756	\$2.18
2003	16,315	54,706	\$3.35
2004	15,157	56,679	\$3.74
2005	9,401	37,439	\$3.98

Source: NMFS 2006

**Figure 10.10. U.S.-farmed salmon production.**



Source: NMFS, 1999, 2003, 2007

3. Oysters and Clams

Farming of bivalve mollusks in the United States is dominated by the production of several different species of oysters and clams (Table 10.3). Two of the most important species, namely *Crassostrea gigas* and *Tapes philippinarum*, are not native to the United States but came originally from Asia. Other cultivated shellfish include mussels, scallops, and geoducks.

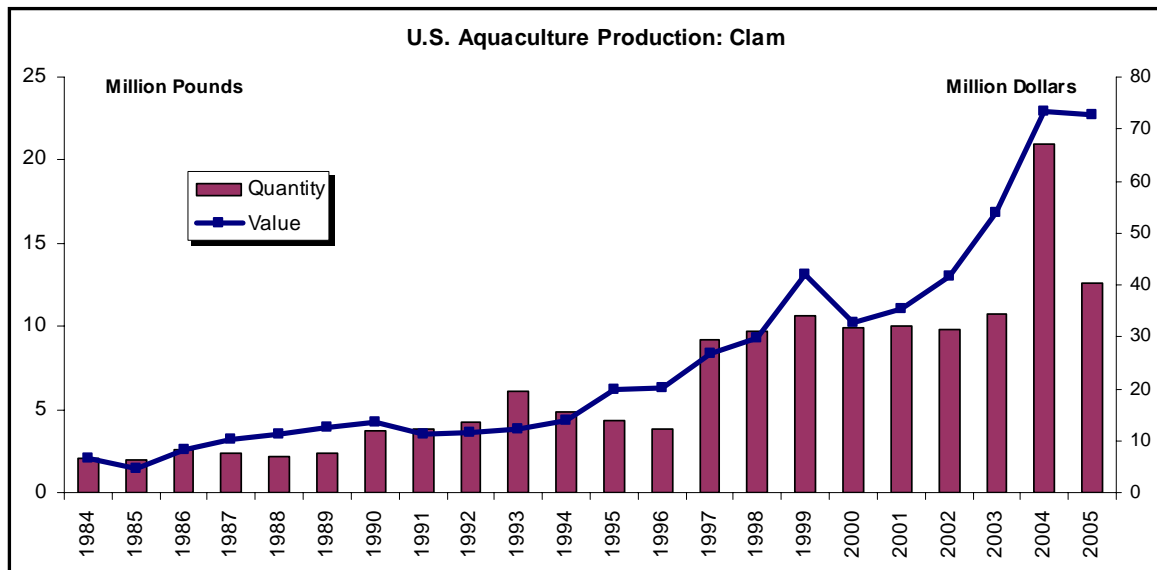
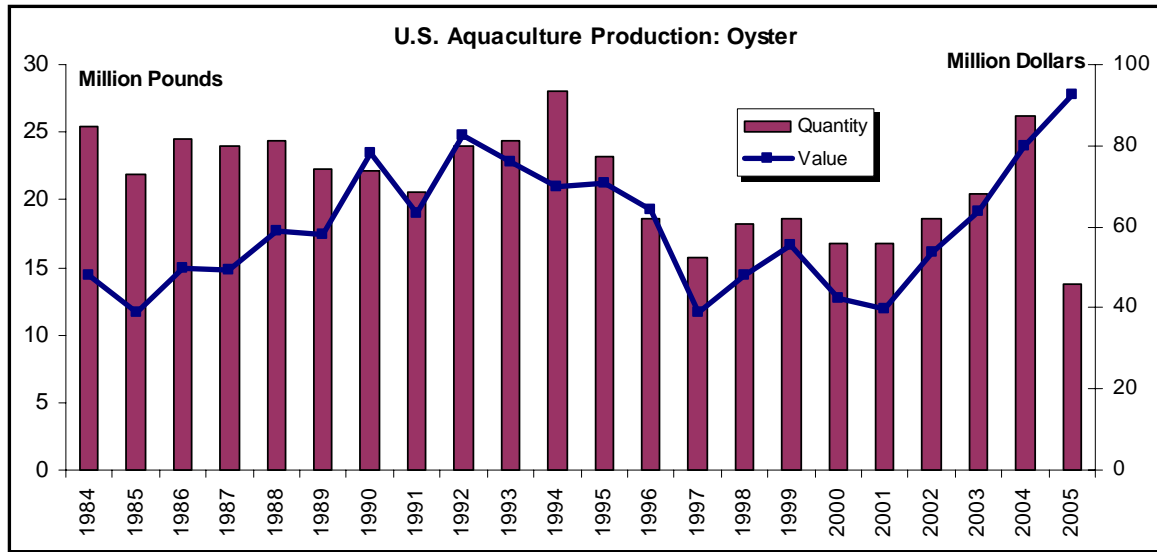
Annual data for the production of oysters and clams from 1984 to 2005 (Figure 10.11) show a combined production total of 26.3 million lbs. meat weight (12.6 million lbs of clams and 13.7 million lbs of oysters) that had a first sale value of \$165.4 million (\$72.8 million of clams and \$92.6 million of oysters). Thus, another feature of the successful bivalve farming industry is the high unit value of its products. As demonstrated here, the average value is \$6.3/lb meat weight.

The methods used for bivalve aquaculture differ from other forms of aquaculture because no food is added to the culture water during the grow-out phase. The shellfish are grown out mostly in protected coastal waters (see Figure 10.12) and feed by filtering large volumes of seawater through their gills to extract the natural phytoplankton (microscopic algae) that are in it. Depending on the species, size, water temperature, and other variables, the volume of water filtered by each animal can be 20 to 80 gallons per day. During nursery and grow-out stages, this demand for water (and associated phytoplankton) and physical space necessitate that it be done in the natural environment. It is neither practical nor economical to culture most shellfish to maturity, which typically takes two to five years, in land-based systems (Kramer et al., 2000).

**Table 10.3. Commercial (farmed and wild) oysters and clams of the U.S.**

<u>Oysters</u>	<u>Scientific name</u>
Pacific oyster	<i>Crassostrea gigas</i>
Olympia oyster	<i>Ostreola conchaphila</i>
European oyster	<i>Ostrea edulis</i>
Kumomoto oyster	<i>Crassostrea sikamea</i>
Eastern oysters	<i>Crassostrea virginica</i>
<u>Clams</u>	
Quahog (hard)	<i>Mercenaria mercenaria</i>
Manila (Pacific)	<i>Tapes philippinarum</i>
Ocean quahog	<i>Arctica islandica</i>
Softshell	<i>Mya arenaria</i>
Surf (Atlantic)	<i>Spisula solidissima</i>
Geoduck	<i>Panope abrupta</i>

**Figure 10.11. U.S.-farmed oyster and clam production.**

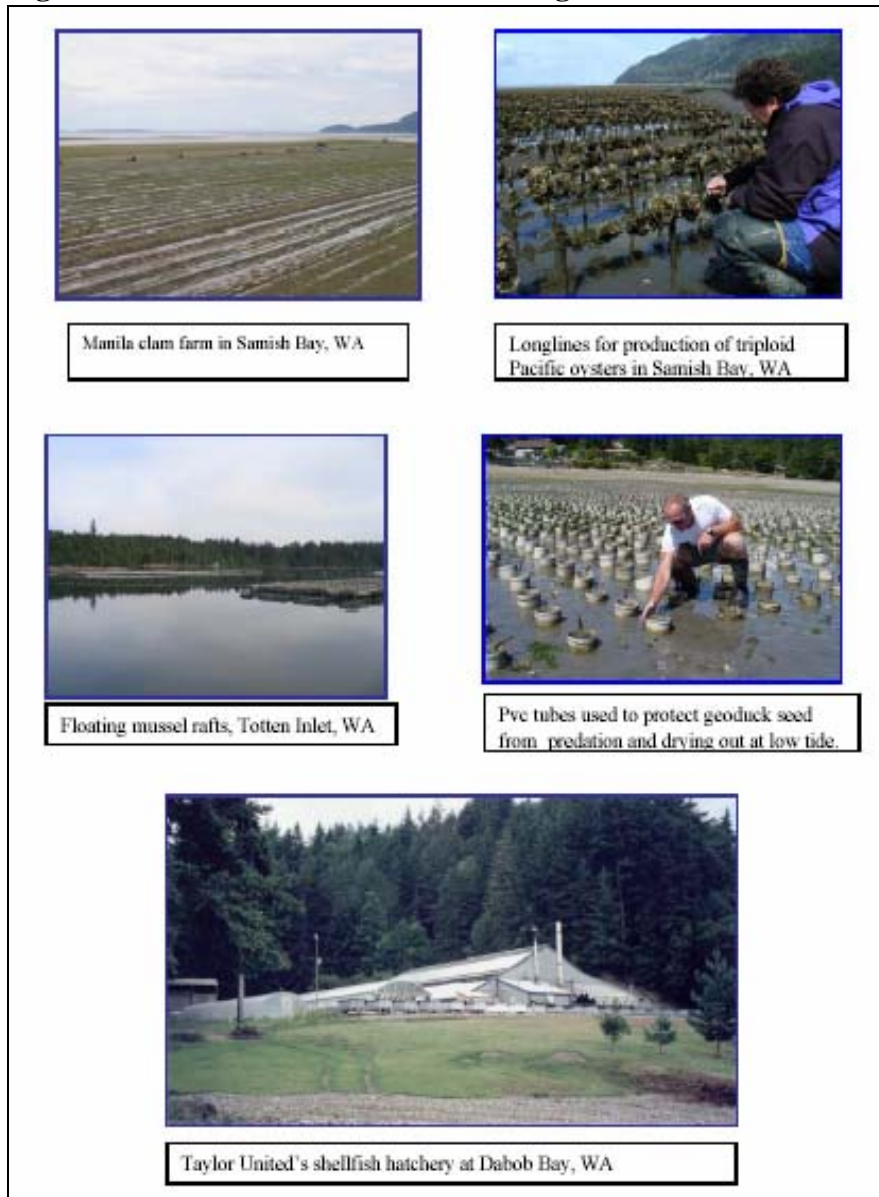


Source: NMFS, 1999, 2003, 2007

This dependence on filtering natural food puts a high premium on the need for clean water for shellfish farming, especially for species such as oysters which are eaten raw. Harvesting closures, due to the presence of potentially harmful bacteria, viruses, and other contaminants, are quite common in shellfish farming, while the industry itself has been and continues to be a strong advocate for clean water. There are, in fact, many cases where the presence of shellfish helps to improve water quality by filtering out particulate matter. For example, Newell (1988) estimated that, prior to 1870; the oyster populations in the Chesapeake Bay were capable in the summer of filtering the entire volume of water in the estuary in three to six days. With reduced stocks of oysters, such filtering is now estimated to be in the order of 300 days, and this may be a contributing factor to the degraded water quality in the Chesapeake Bay today.



**Figure 10.12. Shellfish farms in Washington State.**



Source: Bill Dewey, Taylor Shellfish Farms

Bivalve farming occurs to a greater or lesser extent in every coastal state in the country. Underlying all methods of farming are the basic principles of securing and protecting a stock of shellfish in bodies of clean water from which they can feed, while allowing access to farmers for general care and harvesting. Thus, oysters can be grown on the bottom or in racks and trays, or in the water column using longlines (Figure 10.13), bags strung on lines, or wrapped on pilings (bouchout). Clams, on the other hand, because of their need to dig into the substrate, are almost always grown on the bottom, and are often covered with plastic mesh to protect them from predators.

One difficulty of interpreting production numbers and describing the shellfish farming industry is that shellfish aquaculture activities vary widely. Therefore, determining what actually

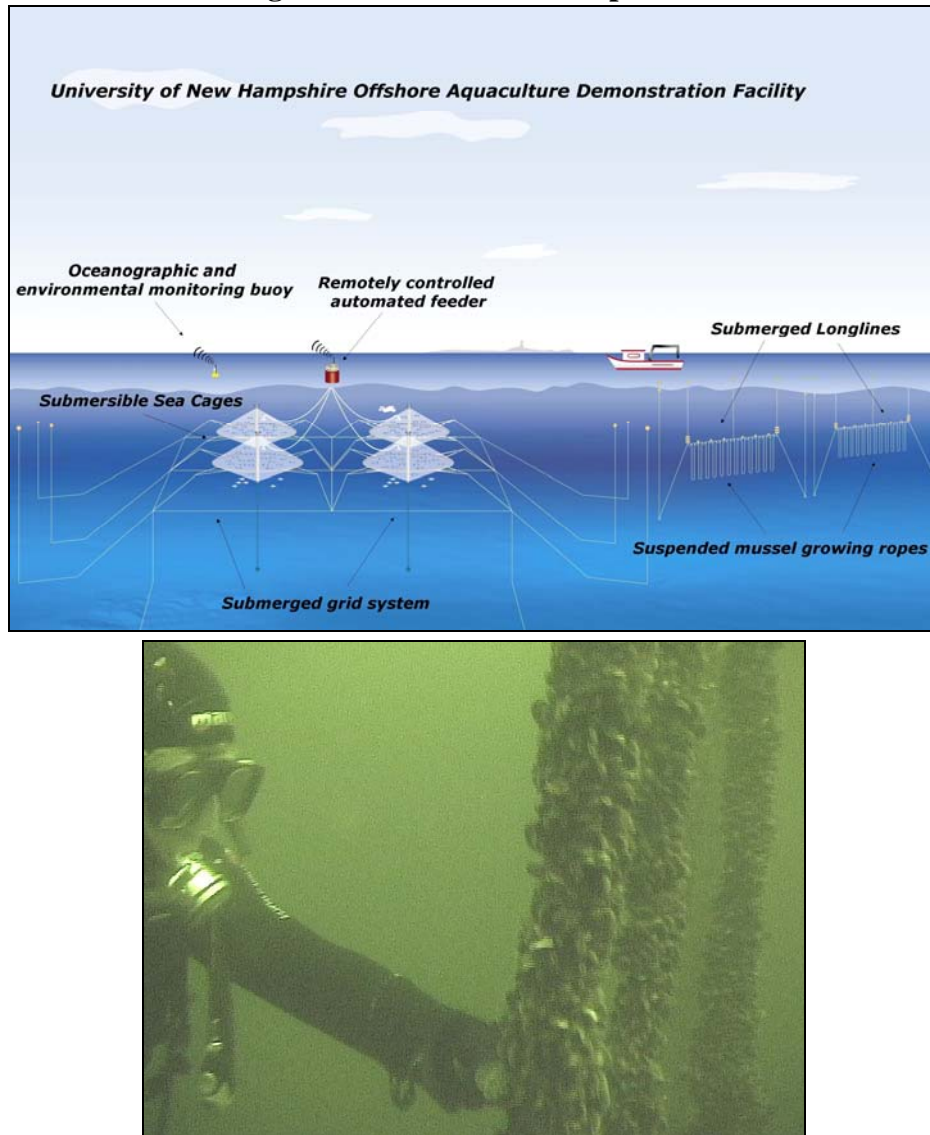
constitutes aquaculture is a challenge. On one side of the spectrum are managed wild fisheries that rely upon natural recruitment to re-seed public beds. Fishermen (and recreational harvesters) get licenses to harvest the wild resource. On the other side is the intensive cultivation of privately-owned tidelands. Beds are seeded with juveniles that began as larvae in a hatchery and are then reared for a period of time in an upland nursery before being planted in some sort of grow-out system. In between these extremes are many other situations, with varying levels of control over the source of the seed stock and the method by which it is grown to market size (Kramer et al., 2000). Difficulties with regard to definition notwithstanding, all U.S. shellfish production is limited by a lack of access to tidelands and coastal waters. Competition for these resources, and pollution in some areas, make expansion difficult. Therefore, industry growth in recent years has been slow, despite the fact that technologies for farming most species are well established and market demand for industry products is strong.

One example of the growth that can occur when tidelands and near-shore coastal waters are made available is the culturing of hard clams in Florida. This began in the early 1990s, primarily through job re-training efforts designed for displaced workers in the commercial fishing industry. By 2003, there were 237 clam farms with annual combined sales of \$13 million (Table 10.4). In turn, these farms supported the activity of hatcheries and land-based nurseries throughout the state while certified shellfish wholesalers in the state purchased the clams and distributed them throughout the nation. An analysis by Philippakos et al. (2001) assessed the aggregate economic impact of this industry at \$34 million. However, hurricanes in 2004 and 2005 caused severe damage to this industry so that by 2005 there were only 153 farms and sales fell to \$9.8 billion with an average price per clam sold of 10.8 cents (Table 10.4 and NASS 2006). There were 20 operations raising clam seed.

Similar loss of growing capacity occurred in the Gulf States' fisheries for oysters, clams, and mussels was caused by Hurricane Katrina in August 2005. The Gulf Oyster Task Force estimated the cost to restore oyster beds and infrastructure over the entire affected area to be more than \$400 million, while the Gulf Oyster Industry Council estimated it to be more than \$335 million (Buck, 2005). When it occurs, restoration will most likely happen with the help of hatchery-produced seed to stock otherwise un-tended public oyster beds. This is an example of how public and /or private hatcheries can serve as an important tool in fishery management.

The outlook for the national oyster and clam production is for only modest growth as has occurred, for example, in Washington over the past 30 years, where losses of capacity due to closures or downgrades in water quality have been offset by developments in farming technology. Growth, if it is to occur, will have to include advances in hatchery production as well as new, on-growing methods that both exclude predators more efficiently and facilitate production in areas not previously developed (Dewey, 2006).

**Figure 10.13. Offshore farming of mussels in New Hampshire.**



Source: University of New Hampshire Atlantic Marine Aquaculture Center

**Table 10.4 Clam farm sales and clam seed planted in Florida during 2005.**

Year	Farms	Farms With Sales	Clams Sold (Millions)	Sales (Millions)
2003	237	192	134.0	\$13.0
2005	153	142	92.1	9.8
			Seed Planted	
2002			289,791,000	
2003			350,398,000	
2004			392,100,000	
2005 (estimated)			350,000,000	
2006 (expected plantings)			500,000,000	

Source NASS 2006

However, one shellfish farming sector that might see more rapid growth is the offshore culture of species such as mussels and scallops that can be grown in suspended culture, i.e. on ropes or in special net containers suspended from floating rafts (Figure 10.13). Should these methods, now being developed at the University of New Hampshire, become widely practiced it could change the present mix of production that characterizes the nation's shellfish farming industry today (Anon 2007).

#### 4. Rainbow trout

Hinshaw et al. (2004), in their review of farming the rainbow trout (*Onchorhynchus mykiss*) in the United States, described the industry as mature and relatively stable. Rainbow trout constitute the overwhelming majority of trout species produced in commercial facilities, but other species, such as the Eastern brook trout (*Salvelinus fontinalis*) and European brown trout (*Salmo trutta*), are also produced in limited numbers. According to the 2005 Census of Aquaculture (NASS, 2006), the national trout industry consists of 410 farming operations located in 38 states. The major producing state is Idaho, with 45% of domestic production by value, followed by Washington, California, North Carolina, Pennsylvania, and Missouri. The majority of these operations are small, family-operated businesses, with average annual sales of about \$193,000. The larger operations, which are only about 20% of the farms by number, account for over 85% of total sales (Hinshaw et al. 2004). This dichotomy in farm sizes exists within most states, with a few large companies or farms producing most of the fish in a respective area.

Rainbow trout, like salmon, grow best in flowing water. Historically and typically, this is supplied by tapping springs or streams and diverting the water flow through ponds or raceways (Figure 10.14). Like salmon, rainbow trout can also be grown in net pens, and because they will acclimate and grow well in saltwater, there has been a substantial increase in marine production of trout worldwide in recent years (Figure 10.15). Most of the recent growth in global trout production has been in saltwater, where the fish are grown to a size larger than is typical for fresh water. In Europe, these saltwater-grown fish are sold as "salmon trout," which reflects the fact that the flesh is red and sizes may be 2-4 kg. In the United States, such fish are sold as steelhead and are mostly imported from Chile, although some production of large trout occurs in fresh water in the states of Washington and North Carolina. Therefore, two quite distinct markets exist for rainbow trout nationally: one, for "portion size" fish - as are produced in most freshwater trout farms, and the other, for "large trout" - as are grown in net-pens.

Production of trout in the United States has lagged behind the rest of the world and remained relatively stable for the last 20 years (Figure 10.15). This reflects the fact that most of the best freshwater sources for raising these fish were identified and secured years ago, especially in Idaho. There are few, if any, sources of freshwater today which could be tapped to expand the industry using typical, flowing water raceway farming. In fact, trout farmers in some states are under pressure to cut production in response to demands for water elsewhere and/or diminishing flow levels from aquifers. A minor exception is the production of larger trout from net pens in freshwater in Washington and North Carolina, although here too opportunities are limited. Meanwhile, farming of trout in saltwater in both Washington and Maine has not been successful compared to Atlantic salmon farming and, in any case, opportunities to expand saltwater net-pen farming in these states are limited.

**Figure 10.14. U.S. rainbow trout farms.**

Figure 8.6 Some different systems in which Rainbow trout are grown



A trout farm using earthen production ponds (from Hinshaw et al. 2004)



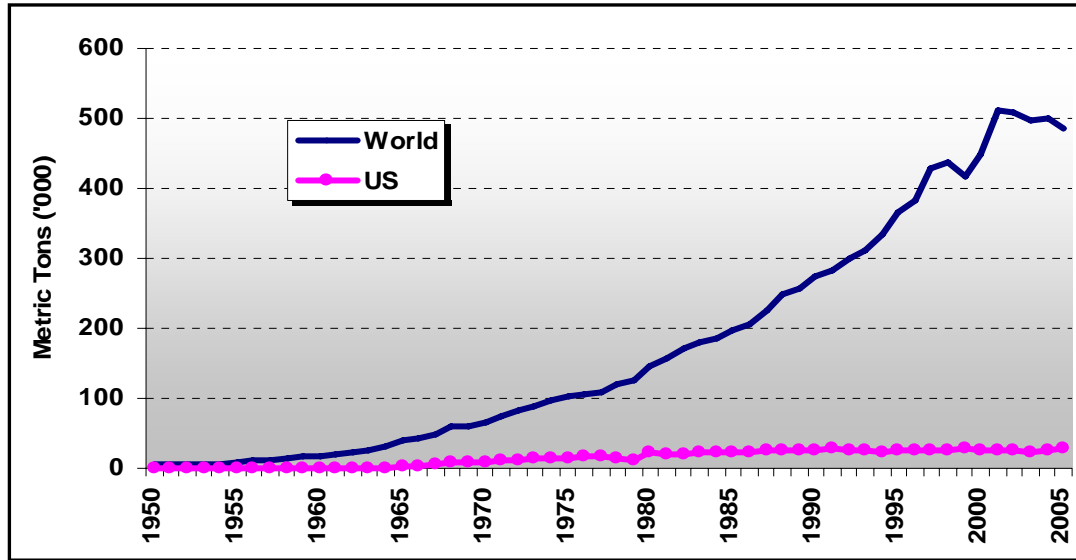
Clear Springs Trout Farm in Idaho uses concrete raceways supplied by spring water



Columbia River Fish Farms in Washington State uses net pens in reservoir of the Columbia River.

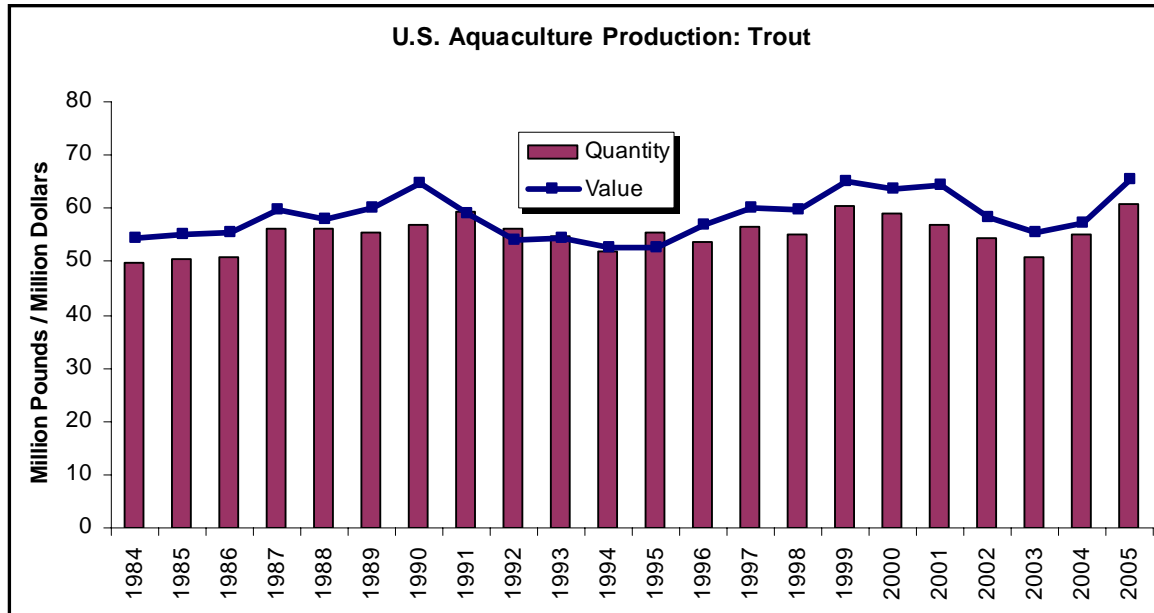
The outlook for U.S. trout farming is continued stability (Figure 10.16). Diminishing water supplies and pressure to reduce water consumption will most likely be countered by even more efficient farming, but the prospects for any possible expansion using traditional flowing water methods seem negligible. Production offshore in saltwater net-pens is feasible along the northeast and northwest coastlines of the country, and especially in the near-shore waters of Alaska, but development is unlikely at present.

**Figure 10.15. World and U.S. production of rainbow trout.**



Source: FAO, 2007

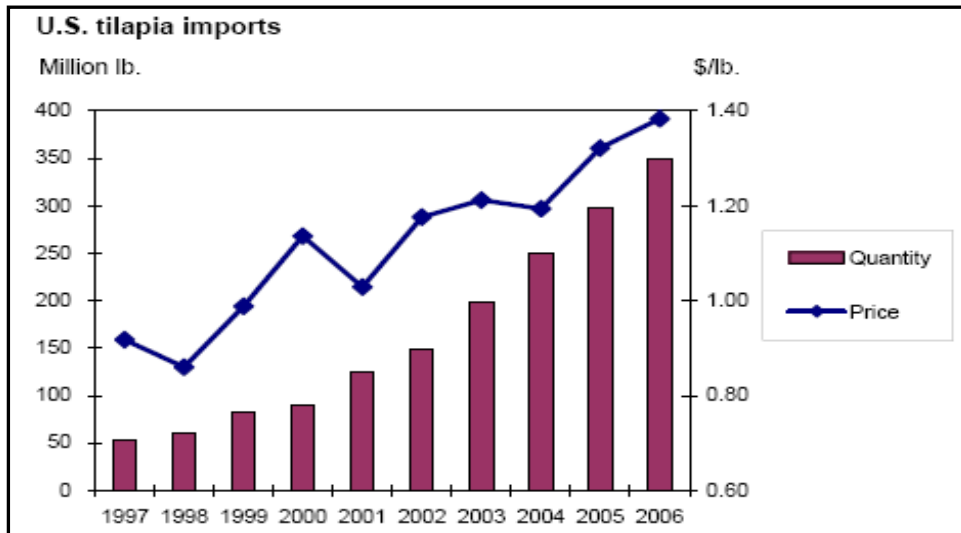
**Figure 10.16. U.S. rainbow trout production.**



Source: NMFS, 1999, 2003, 2007

**5. *Tilapia and recirculation aquaculture systems (RAS).***

A smaller but important part of American food fish aquaculture is the farming of tilapia. It is important for two reasons. First, tilapia has become a popular food fish in the United States in recent years with most supplies coming from overseas producers especially in Central and South America and Asia (Figure 10.17). Second, almost 8,000 mt of this tilapia is grown in the United States (Table 10.1) in recirculating aquaculture systems (RAS) where, by continuous recycling and reconditioning of the culture water, the temperature can be maintained at a level at which

**Figure 10.17. Tilapia imports in the United States.**

Source: *Aquaculture Outlook*, April 2007

a tropical fish like tilapia grows well. These fish are almost all sold live in areas where certain ethnic groups prefer to buy their fish in this way, and they are sold at premium prices compared to imported processed tilapia products

Control of water temperature in RAS at any level that the operator chooses means that this technology can be used, in principle, to grow any species of fish. Therefore RAS have numerous potential applications in aquaculture and are the subject of intense research. The key challenge is to be able to build and operate them at a cost that allows them to compete with other methods of aquaculture as described above. Higher costs in RAS result from the investment needed for water treatment and control equipment and the energy, biosecurity, and other costs of operation (Figure 10.21). Presently, RAS are most successful when used to grow high value products such as live tilapia, sturgeon for the production of caviar, and barramundi. They are also being used increasingly in hatcheries where controlling both temperature and microbial content of water makes them especially suitable for culturing the delicate early life stages of many species, including salmon. For the same reason, almost all public aquariums are RAS and the technology is also used in ornamental fish breeding.

Another benefit of RAS is that they use and discharge much less water than other methods of aquaculture. Therefore, there is greater flexibility as to where they can be located because they are not so dependent on large natural water sources for their water supply and their waste water can be treated before discharge back into natural water bodies.

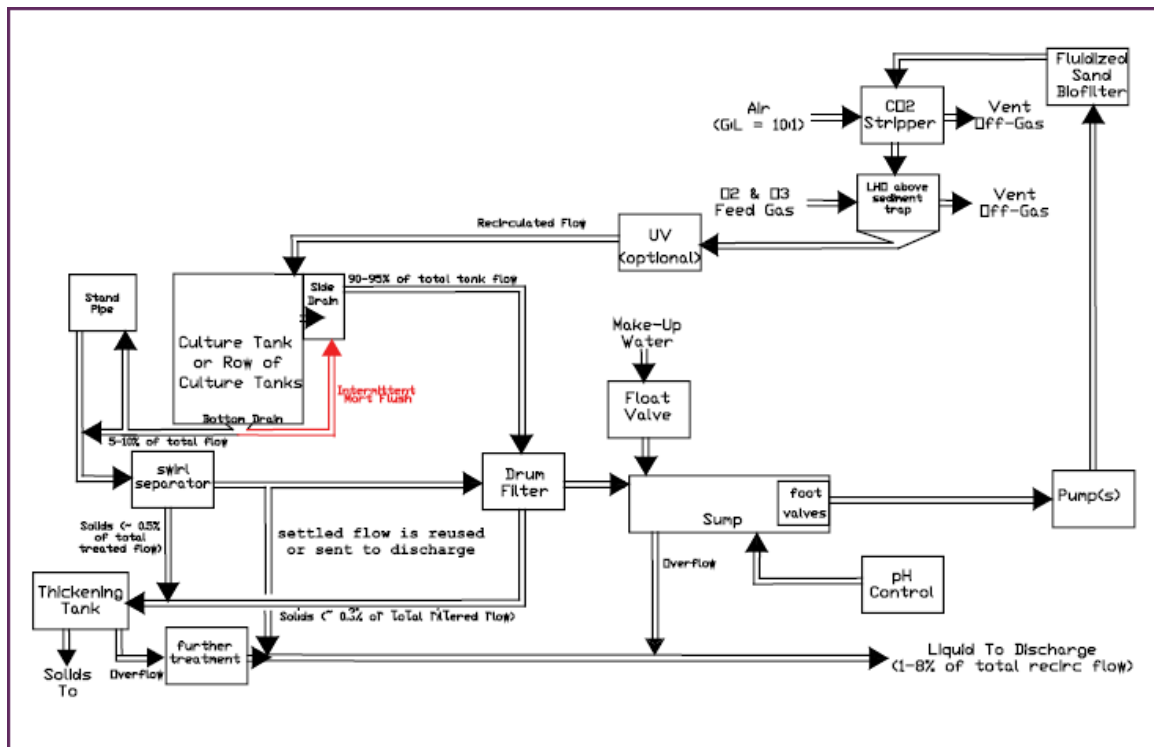
#### 6. Public sector aquaculture

Hatchery-reared fingerlings and spat are released to enhance commercial and recreational catch or to restore threatened or endangered populations of fish and shellfish. Also, shellfish spat and marsh grasses are produced by public hatcheries or private companies for public programs to rebuild shellfish and marsh habitat. Statistics for the production of juveniles to support the recreational fishing industry are separated from the statistics for annual commercial

**Figure 10.18 A Recirculating Aquaculture System (RAS) for Tilapia and Process Flow Diagram.**



*Figure 3. A RAS using a CycloBio Filter, Low Head Oxygenation (LHO) Unit and Stripping Columns. Water flow exiting the top of the fluidized-sand biofilter flows by gravity through a cascade stripping column, an LHO unit, and a UV irradiation unit before being piped by gravity to the culture tank. Photo courtesy of the Conservation Fund Freshwater Institute (Shepherdstown, WV).*



Source Timmons and Ebeling 2006



aquaculture production in most state and federal fisheries and aquaculture reports. The most common species raised and stocked to support recreational fisheries are bluegill, catfish, largemouth and smallmouth bass, muskellunge, northern pike, salmon and trout, sauger and walleye, steelhead, striped bass, and sunfish (Nash, 1995). Hundreds of millions of juveniles are raised each year in over 75 hatcheries operated by the U.S. Fish and Wildlife Service's National Fish Hatchery System, more than 1,000 private hatcheries and hundreds of state hatcheries.

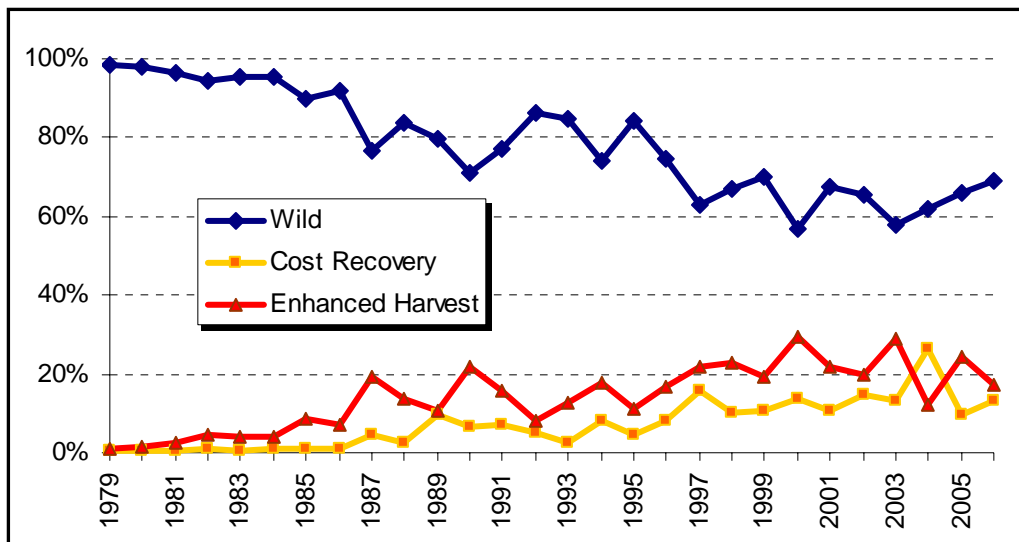
Production volumes for stocking from restoration and enhancement hatcheries for marine species are hard to pin down. Hatchery-based production of fingerlings has been or was conducted for many years to enhance or restore fisheries for striped bass on the East Coast and Gulf, for red fish in the Gulf, and white sea bass in California. However, data for yields directly attributable to released fish are not available (Drawbridge, 2006; Leber, 2006), except for salmon for which it is possible to make an estimate of value, though not weight, by making certain assumptions.

The numbers and values for releases and catches of hatchery-raised salmon on the West Coast and Alaska vary. Data for production from Pacific salmon enhancement hatcheries in Alaska (see Figure 10.19) have been summarized by White (2005) and McGee (undated). According to White,

*“Over 1.5 billion eggs were collected by Alaskan hatchery operators in 2005. In addition, over 1.4 billion fish were released. An estimated 80 million salmon of hatchery origin returned. Of the 200 million salmon harvested in the commercial common property fishery, over 53 million or 27% of the harvest was contributed by ocean ranching by the Alaska salmon enhancement program. Enhanced salmon provided over \$39 million or 14% of the preliminary value of the common property harvest. The ocean ranching program provides hundreds of Alaskans with seasonal and full time jobs. It is considered the largest agricultural industry in Alaska.”*

The fact that 27% of the harvest contributed only 14% of the value is because the vast majority of hatchery-reared salmon for stock enhancement are chum and pink salmon. These are the least valuable species but also the easiest to rear in a hatchery. However, the actual contribution of salmon hatcheries in Alaska may be higher than the number provided by White (2005). For example, Knapp et al (2007) included both cost recovery harvest and enhanced fish harvest as contribution of hatchery-based salmon farming to commercial harvest and estimated the total enhanced harvest represented 33.8% of the total commercial harvest in 2005, rather than 14% as stated by White.

In contrast, hatchery releases from federal, state, and tribal hatcheries in Washington, Oregon, and California are mostly of the higher-value salmon species such as Chinook and Coho salmon. Bartlett (2005) reported that almost 300 million salmon in total were released into Pacific Northwest waters in 2004 and that 4,640 tons of Chinook and 244 tons of Coho were caught in the commercial fisheries in the same year. Furthermore, he indicated that coastal and freshwater fisheries and the sport fisheries took another 3,699 tons of Chinook and 2,710 tons of Coho, assuming the same average weights as in the commercial fisheries.

**Figure 10.19. Contribution of hatchery-reared salmon to the Alaskan fishery.**

Source: ADFG, 1979-2005

The ex-vessel value of the non-Indian commercial ocean fishery for salmon in these three coastal states in 2004 was \$29 million. Although a value for fish harvested in coastal and fresh waters and in sport fisheries is not provided, it is clear that this value is at least as large as that of the commercial fishery, if not more. Therefore, a reasonable approximation of aggregate weights and values from these hatchery-enhanced fisheries in Washington, Oregon, and California is 8,000 tons of Chinook salmon and 3,000 tons of Coho, yielding a total ex-vessel equivalent value of about \$60 million suggesting that enhancement aquaculture is one of the country's major aquaculture activities.

For completeness, it must also be noted that there are hatcheries for enhancement and/or restoration of Atlantic salmon on the East Coast and for certain Pacific salmon species in the Great Lakes. However, none of these programs supports a commercial fishery; therefore, they do not contribute to the overall commercial value.

## References

- Anon 2007. Offshore mussel farm is USA first. *Fish Farming International*. 34(11):7.
- Bartlett, H.R. 2005. Washington, Oregon, and California salmon hatchery releases. Commercial and Sport Fishery Catch Statistics for 2004 the Season. Washington Department of Fisheries and Wildlife. NPAFC Doc. No 909 Rev. 1, 6pp.
- Buck, G. 2005. Hurricanes Katrina and Rita: fishing and aquaculture industries - damage and recovery. CRS Report for Congress. Order Code RS22241.
- Dewey, William. 2006. Personal communication.
- Drawbridge, Mark. 2006. Personal communication.

Dean, S. and T. Hanson, 2003. Economic Impact of the Mississippi Farm-Raised Catfish Industry at the Year 2003. Miss. State Univ. Extension Publication #2317

FAO (Food and Agriculture Organization of the United Nations). 2007. FishStat Plus: Universal Software for Fishery Statistical Time Series.

Haley, M.M. 2008. Livestock, Dairy and Poultry Outlook. A report from the Economic Research Service, U.S. Department of Agriculture, April 17, 2008. [www.ers.usda.gov](http://www.ers.usda.gov)

Hanson, T.R., S. Dean, and S.R. Spurlock. 2004. Economic Impact of the Farm-Raised Catfish Industry on the Mississippi State Economy. *Journal of Applied Aquaculture* 15 (1/2):11-28.

Harvey, D. 2006. Aquaculture Outlook. USDA, ERS, LDP – AQS-23.

Hinshaw, J., G. Fornshel, and R. Kinnunen. 2004. A profile of the aquaculture of trout in the United States. USDA, Risk Management Agency, Federal Crop Insurance Corporation, through Mississippi State University. Agreement RMA 01-IE-0831-127.

Knapp, G., C.A. Roheim, and J.L. Anderson. 2007. The Great Salmon Run: Competition between Wild and Farmed Salmon. Traffic North America, World Wildlife Fund, Washington, DC

Kraeuter, D., B. Dewey, B., and M. Rice. 2000. Response to EPA's aquaculture industry regulatory development data needs. Joint Subcommittee on Aquaculture, Aquaculture Effluent Task Force. Molluscan Shellfish Aquaculture Technical Subgroup.

Leber, K. 2006. Personal communication.

McGee, S. Undated. Salmon hatcheries in Alaska – plans, permits, and policies to protect wild stocks. <http://www.lltk.org/>

Nash, C.E. 1995. Aquaculture Sector Planning and Management. Fishing News Books, Blackwell Science, Ltd., Osney Mead, Oxford, U.K.

National Agricultural Statistical Service (NASS). 2006. Aquaculture, October 2006. [www.nass.usda.gov/Statistics\\_by\\_State/Florida/Publications/Aquaculture/06aqua4.doc](http://www.nass.usda.gov/Statistics_by_State/Florida/Publications/Aquaculture/06aqua4.doc)

National Agricultural Statistical Service (NASS). 2008. Catfish News <http://catfishnews.com/markets.htm>

NMFS (National Marine Fisheries Service). 2007. Fisheries of the United States 2006. Current Fishery Statistics No. 2006, NOAA/NMFS, Silver Spring, Maryland.

NMFS (National Marine Fisheries Service). 2003. Fisheries of the United States 2002. Current Fishery Statistics No. 2002, NOAA/NMFS, Silver Spring, Maryland.

NMFS (National Marine Fisheries Service). 1999. Fisheries of the United States 1996. Current Fishery Statistics No. 1996, NOAA/NMFS, Silver Spring, Maryland.

Newell, R.I.E. 1988. Ecological changes in Chesapeake Bay: are they the result of overharvesting the American oyster, *Crassostrea virginica*? Chesapeake Research Consortium, Publication 129.

Philippakos, E., C. Adams, A. Hodges, D. Mulkey, D. Comer, and L.N. Sturmer. 2001. The economic impact of the Florida cultured hard clam industry. University of Florida Sea Grant (SGR 123), Gainesville, FL, 23 pp.

Ruth, A., L. Sturmer, and C. Adams. 2003. Organizational structures and strategies for the hard clam aquaculture industry in Florida. Submitted to the USDA Risk Management Agency. The Targeted Commodity Partnerships for the Risk Management Education Program; Report on Project 02-1E0831-0105.

Seafood Intelligence. 2008. What news from Hell. Norway registers formidable salmon production; Chile and Canada down. (Jan 26<sup>th</sup>)  
<http://www.seafoodintelligence.com/EditModule.aspx?tabid=145&mid=574&def=News%20Article%20View&ItemId=16299>

Timmons, M., and J. Ebeling. 2006. Recirculating Aquaculture System (RAS) Technologies. Part *Aquaculture Magazine* Sept / Oct 2006 32 - 39.

Tucker, C., J. Avery, C. Engle, and A Goodwin. 2004. Industry profile: pond-raised channel catfish. USDA Risk Management Agency, Federal Crop Insurance Corporation, through Mississippi State University. Agreement No. RMA 01-IE-0831-127.

United States Department of Agriculture (USDA). 2005 Census of Aquaculture.  
<http://www.agcensus.usda.gov/Publications/2002/Aquaculture/index.asp>

White, B. 2005. Alaska salmon enhancement program - 2005 annual report. Fishery Management Report No. 06-19.

# CHAPTER 11

## Future Markets for Aquaculture Products

James Anderson and Gina Shamshak

---

*This chapter compares the global seafood industry to other animal protein industries and examines the general trends shaping the future of the U.S. seafood industry.*

### The Seafood Industry

How does the seafood sector compare to other animal protein sectors? Consider the following characterization of the global seafood industry:

- The global seafood industry is the most complex and diverse animal protein sector especially in terms of the number of species and the variety of harvest technologies. There are over 800 species traded, ranging from urchin to oyster to salmon to swordfish (Anderson, 2003). The industry still uses harvesting technologies that date back thousands of years (nets, spears, and harpoons); however, it also employs some of the most advanced technologies in aquaculture and fishing systems.
- It is by far the most international of all the animal proteins. International trade in fish is valued at more than twice the trade in all other meats and poultry combined (FAO, 2004).
- It is the most fragmented industry, with tens of thousands of companies spread around the world.
- Few would argue with the claim that the seafood sector faces the most bureaucratic and inefficient regulatory environment, relative to any other food sector.
- Compared to other animal protein sectors, it is remarkably wasteful. The levels of bycatch and processing wastes are staggering. The race to find and capture fish has often resulted in excess capacity, overcapitalization, and/or regulated inefficiency, all of which waste resources.
- Seafood is definitely the most misunderstood animal protein by both consumers and chefs. The lack of knowledge regarding preparation, handling, nutritional characteristics, origin, and species is truly remarkable, especially in the U.S. The media are full of misinformation and biased content.
- Seafood trade occurs in a global marketplace which lacks transparency. There are few, well-run wholesale markets in the U.S. In general, accurate and timely information about prices and market conditions is difficult to obtain or non-existent.
- All of these factors result in a seafood sector which is highly volatile compared to the other animal protein sectors.

The factors above undermine efficiency, market planning, and market development. Growth in market share will come from the sub-sectors of the seafood industry that can change the industry from the one characterized above to one that is more like the traditional animal protein sectors (such as beef and poultry). That future belongs to aquaculture and the few well-managed wild fisheries. To understand this position more thoroughly, consider the expectations for seafood consumption in the future.

## **Expectations: World Supply and Demand**

In a recent study, Delgado et al. (2003) projected the global demand for seafood will grow 38% from 133 million metric tons (mmt) in 1999/2000 to approximately 183 mmt in 2015. This represents an annual increase of about 2.1%, compared to an annual growth rate of 3.1% over the prior two decades. They expect 46% of this growth to come from population increases and 54% to come from economic development and other factors.

Their report also projects the source of the supply required to meet the forecasted demand. They expect that 73% will come from aquaculture, while most traditional capture fisheries are expected to stagnate. Only 27% of the growth in supply is expected to come from traditional fisheries. In particular, they expect the share of supply derived from pelagic and demersal fisheries to decline.

## **Expectations: U.S. Market**

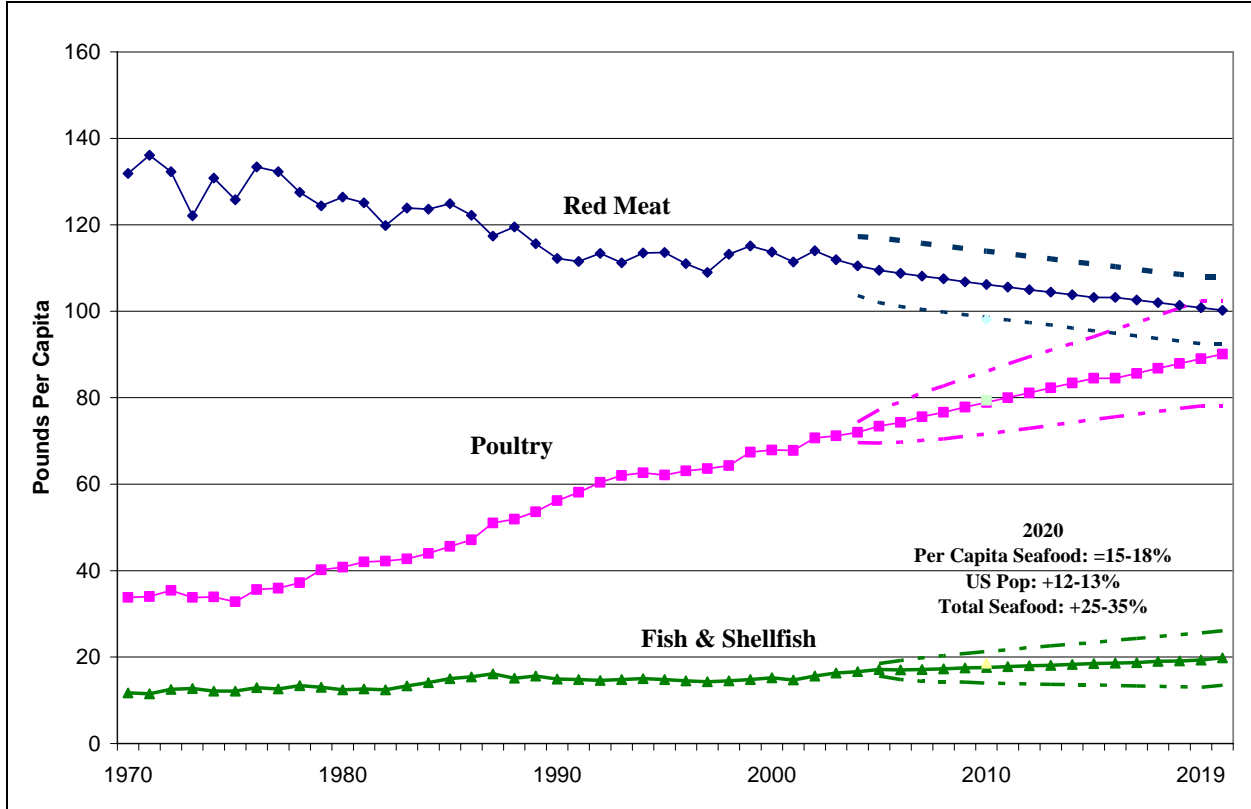
Figure 11.1 illustrates U.S. per-capita consumption of red meat, poultry and seafood. Expected per-capita consumption for the three categories was forecasted out to 2020 using a basic state-space time series model. Red meat per-capita consumption is expected to decline by about 9% over the next 15 years, and poultry per-capita consumption is expected to increase nearly 40% (barring an outbreak of Avian flu). Growth in seafood consumption is expected to increase 14-17%, from 16.6 pounds per capita to over 19 pounds per capita by 2020. Given that the U.S. population is expected to grow 12-13%, additional seafood requirements are likely to range between 25 to 35% more than are currently available. These expectations are in line with the forecasts by Delgado et al. (2003) for global demand. Demand could also expand as consumers seek out seafood products due to their associated health benefits. Demand could also expand as consumers seek out seafood products due to their health benefits. Seafood is an excellent source of high quality proteins and long chain omega-3 fatty acids, including EPA (eicosapentaenoic acid) and DHA (docosahexaenoic acid). Both DHA and EPA provide essential health benefits, including cardiovascular health, improved cellular function, and overall brain and nervous system function. The consumption of omega-3 fatty acids is beneficial especially with regard to cardiovascular health (Seierstad et al., 2005; Kris-Etherton et al., 2002; Eliseo et al., 2002; Connor, 2000; Kromhout et al., 1985). Advances in aquaculture production will be required to meet this expected demand. With improved marketing and advances in technology, these forecasts may be conservative.

## **Current Market Trends**

Consider how the market has been changing over the past decade or so. Table 11.1 shows two significant changes in the U.S. seafood market. The first startling observation is that growth in per-capita consumption is occurring almost exclusively among aquaculture-based species. Since 1987, salmon is up 403%, shrimp is up 74%, catfish is up 91%; and tilapia wasn't even measured in 1987. In contrast, many traditional fisheries are stable or declining: cod is down 62%; clams are down 21%; flatfish are off the top ten list; and tuna and scallops remain essentially unchanged.

A second observation is that the market for seafood is becoming more concentrated. Note that the top five species account for 76% of total consumption in 2003, compared to 56% in 1987. Furthermore, the top ten species now account for 93% of total seafood per-capita consumption. This concentration is coming from consolidation in the seafood business, which is driven in large part by the presence of the aquaculture sector. The aquaculture sector is not just increasing global seafood supply, it is also reducing supply uncertainty and providing a more consistent, high-quality product. This leads to better marketing and new product development.

**Figure 11.1. U.S. per capita consumption of red meat, poultry, and fish/shellfish actual (1970-2004) and forecast (2005-2020).**



Source: USDA, 2004; NMFS, 2004

Seafood product diversity in the future will not necessarily come from the next “new” species; rather, it will come from the same species with a new preparation, sauce, product form, or image (such as organic). The U.S. catfish industry, for example, has expanded its market share by making catfish appear different with sauces, flavors, and coatings. Producers within the tilapia industry will likely do the same to increase market share and expand product lines.

The trend toward aquacultured species is further substantiated by the data collected in the annual retail survey conducted by *Seafood Business*. As can be seen in Table 11.2, top selling species (salmon, tilapia, shrimp, and catfish) are now dominated by aquaculture. Ten years ago pollock, cod, haddock, and flounder were the top sellers.

**Table 11.1. United States seafood consumption changes from 1987 to 2003.**

<b>Edible kg per Capita</b>						
	<b>1987</b>			<b>2003</b>		<b>% Change</b>
71%	Tuna	1.59	56%	Shrimp	1.81	+74
	Shrimp	1.04		Tuna	1.54	-3
	Cod	0.76		Salmon	1.01	+403
	AK Pollock	0.40		AK Pollock	0.77	+93
	Flatfish	0.33		Catfish	0.52	+91
	Clams	0.30		Cod	0.29	-62
	Catfish	0.27		Crab	0.28	+84
	Salmon	0.20		Clams	0.25	-21
	Crab	0.15		Tilapia	0.24	NA
	Scallops	0.15		Scallops	0.15	0
	Other	2.16		Other	0.55	-75
Total	7.35	Total	7.40	+1		

Source: NMFS(2004) and NFI (1988, 2005)

**Expectations: Global Supply**

Globally, supplies from traditional fisheries will either remain flat or decline over time. Figures 11.2 & 11.3 demonstrate the trend in traditional capture fisheries production, where harvests have been stable or declining over the past 20 years. Increases in global seafood supply will not come from traditional fisheries. Many fisheries are already fully exploited and any increases in harvest levels will only reduce the stock and ultimately decrease, rather than increase, harvest levels. Instead, any increases in total global fisheries production will come from the aquaculture sector.

In contrast to Figures 11.2 and 11.3, which represent stagnant or declining global supply in traditional fisheries over the past 20 years, Figures 11.4 & 11.5 demonstrate the extraordinary expansion in production that occurred and will continue to occur in the aquaculture sector.

Global production of salmon and trout, as well as tilapia, has exhibited remarkable growth over the past two decades. Production by these sectors has steadily increased, unlike the situation for traditionally harvested flatfish and cods. Interestingly, tilapia imports in the U.S. are likely to surpass salmon imports within the next 15 years (Figure 11.6). One reason for the rapid growth in tilapia, in addition to technological and genetic advances, is the substitution of tilapia for traditional whitefish, as supply from traditional capture fisheries remains static or declines.

The emergence of offshore aquaculture could alter this scenario, especially if species such as cod and haddock are raised in offshore aquaculture operations. Even if these species are not raised domestically, the importation of these and other aquaculture species will continue, and most likely increase, as the forecasted gap between domestic demand and supply for seafood widens.



**Table 11.2. Seafood Business Retail Survey: U.S. Retail Sales, 1994 vs. 2004. Best Sellers**

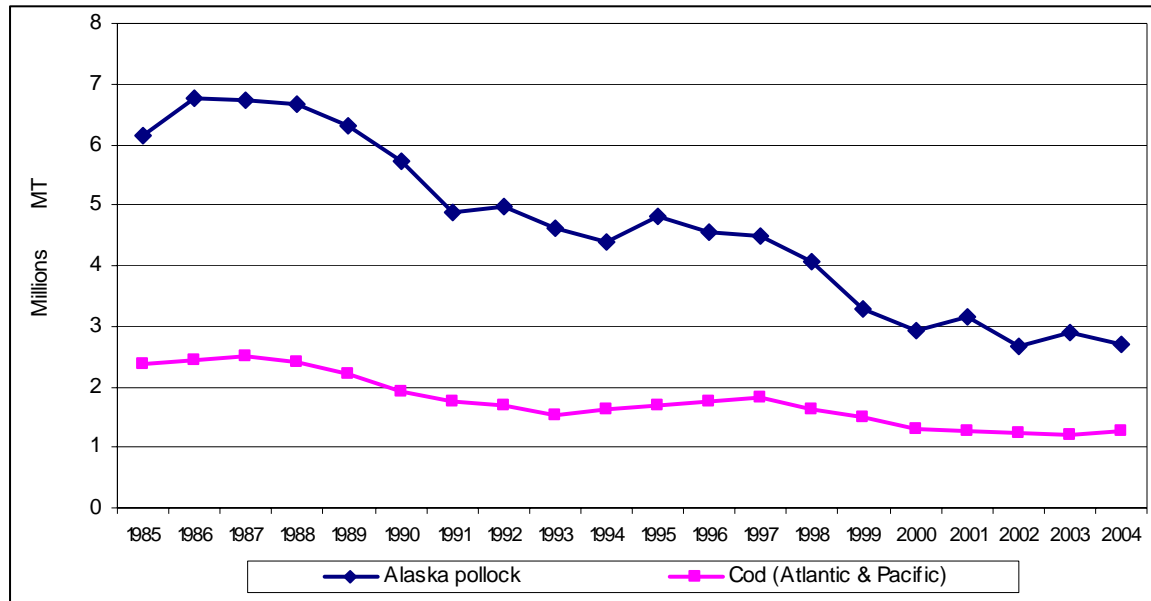
	1994	2004
1	Shrimp	Shrimp
2	Salmon	Salmon
3	Pollock, Cod, Haddock	Tilapia
4	Catfish	Tuna
5	Flounder	Catfish

**Fastest Growing Items**

	1994	2004
1	Salmon	Salmon
2	Shrimp	Tilapia
3	Tilapia	Shrimp
4	Catfish	Tuna
5	Orange Roughy	Crab

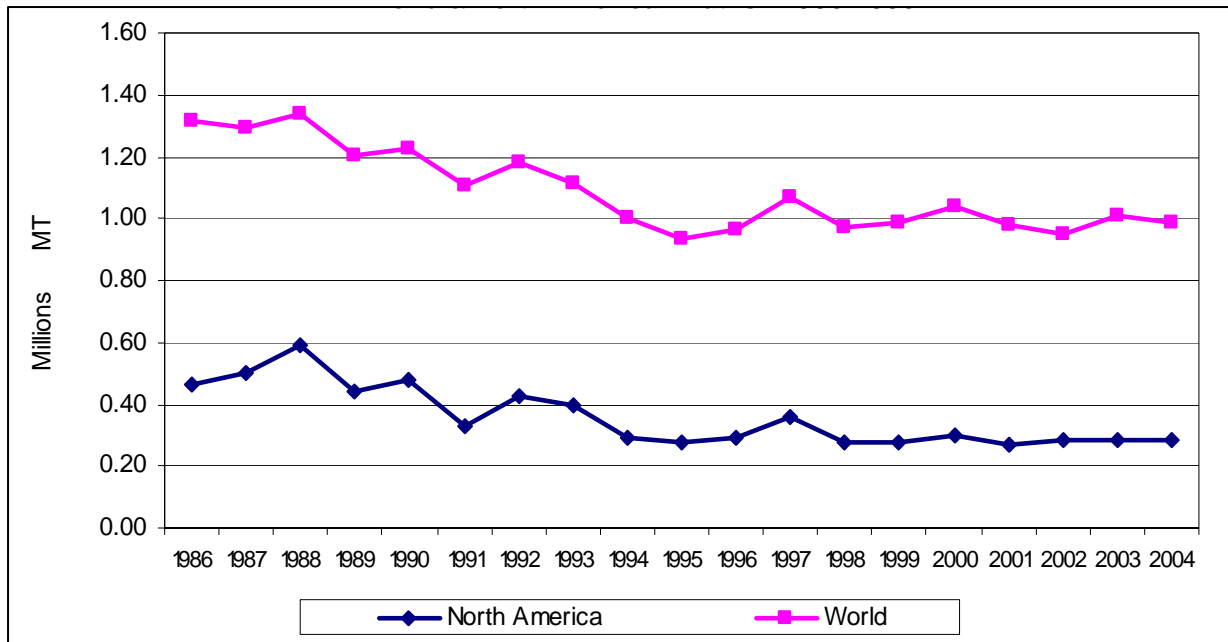
Source: Perkins, 1994; and Robinson, 2004

**Figure 11.2. World harvest of Alaskan pollock and cod 1985-2004.**



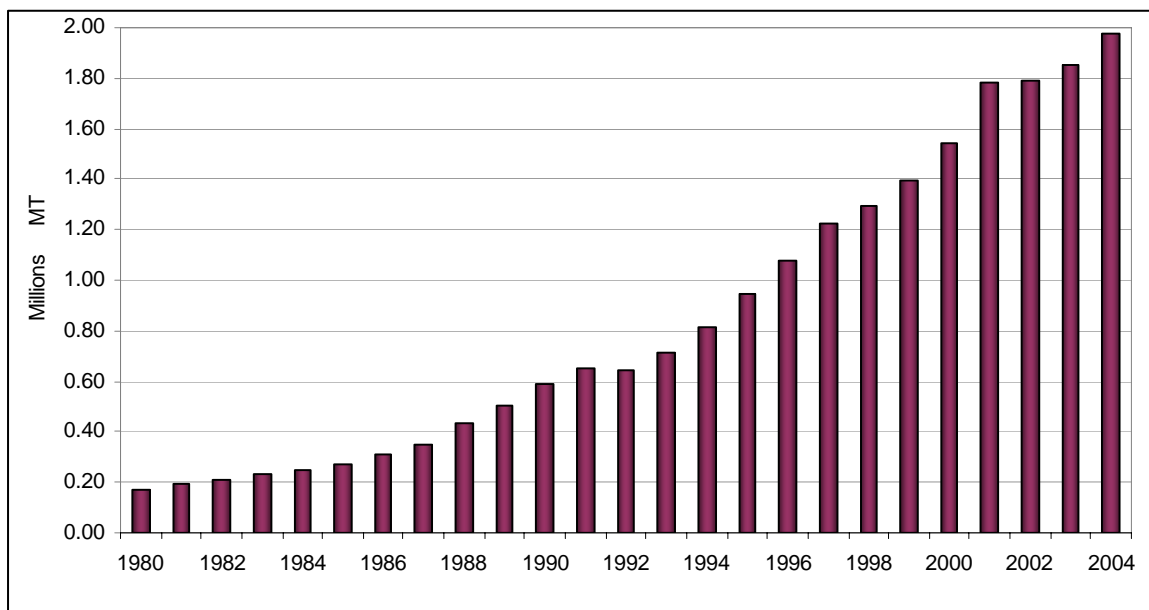
Source: FAO, 2006

**Figure 11.3. World and North American flatfish 1986-2006.**



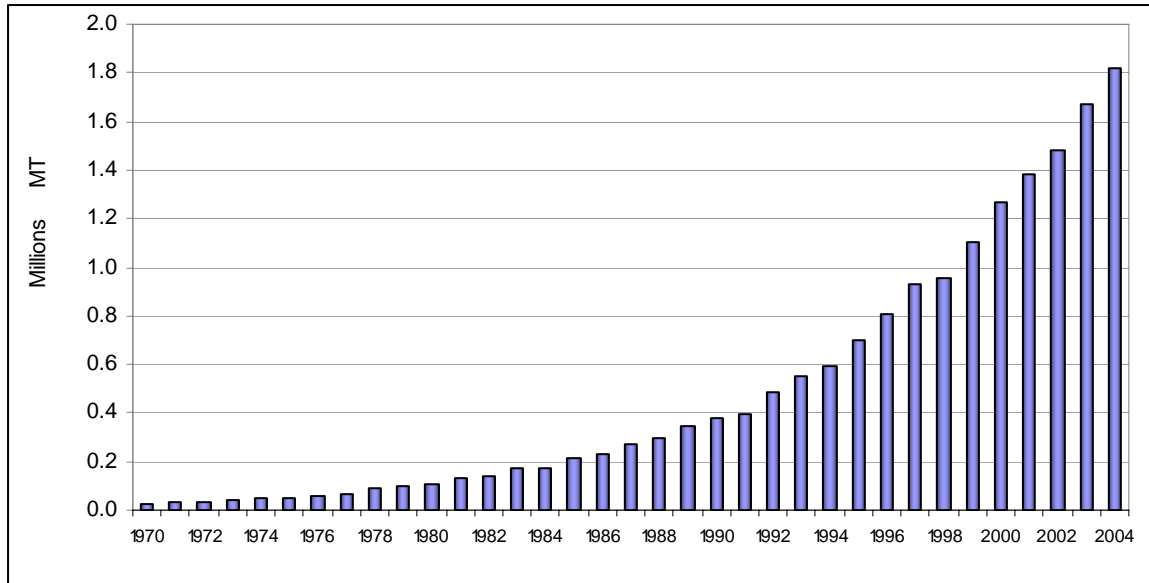
Source: FAO, 2006

**Figure 11.4. World salmon and trout aquaculture.**



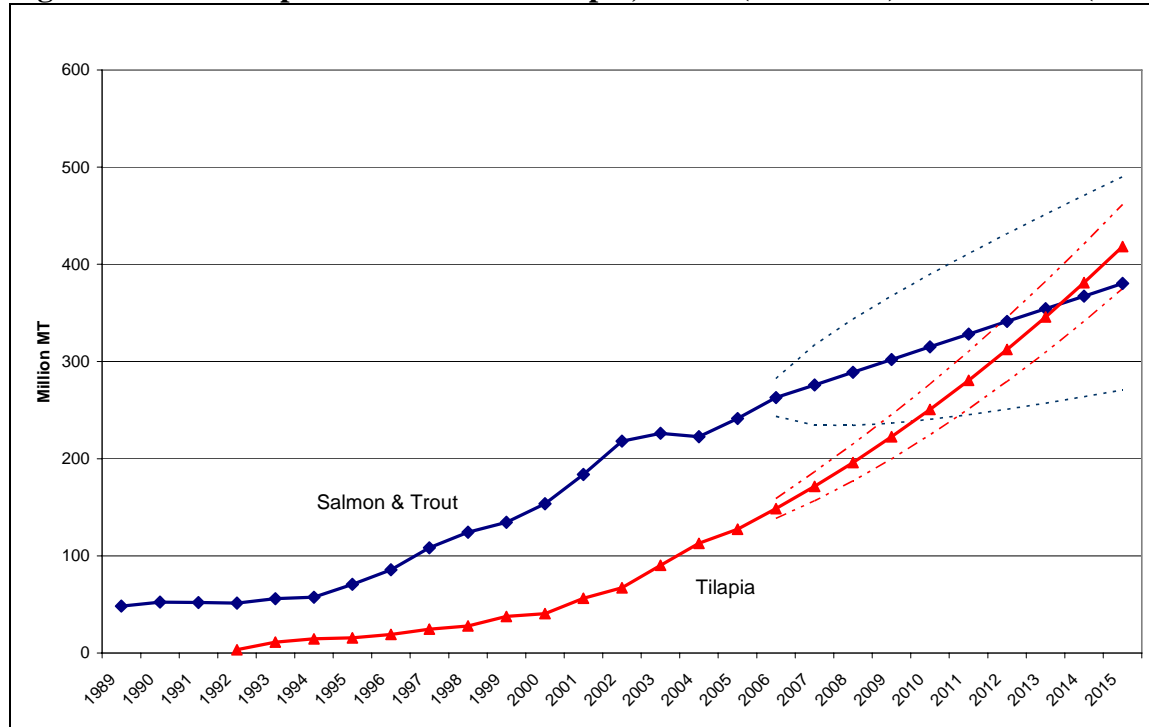
Source: FAO, 2006

**Figure 11.5. World tilapia aquaculture.**



Source: FAO, 2006

**Figure 11.6. U.S. imports of salmon vs. tilapia, actual (1989-2005) and forecast (2006-2015).**



Source: USDC, 2005

## **Aquaculture vs. Traditional Fisheries**

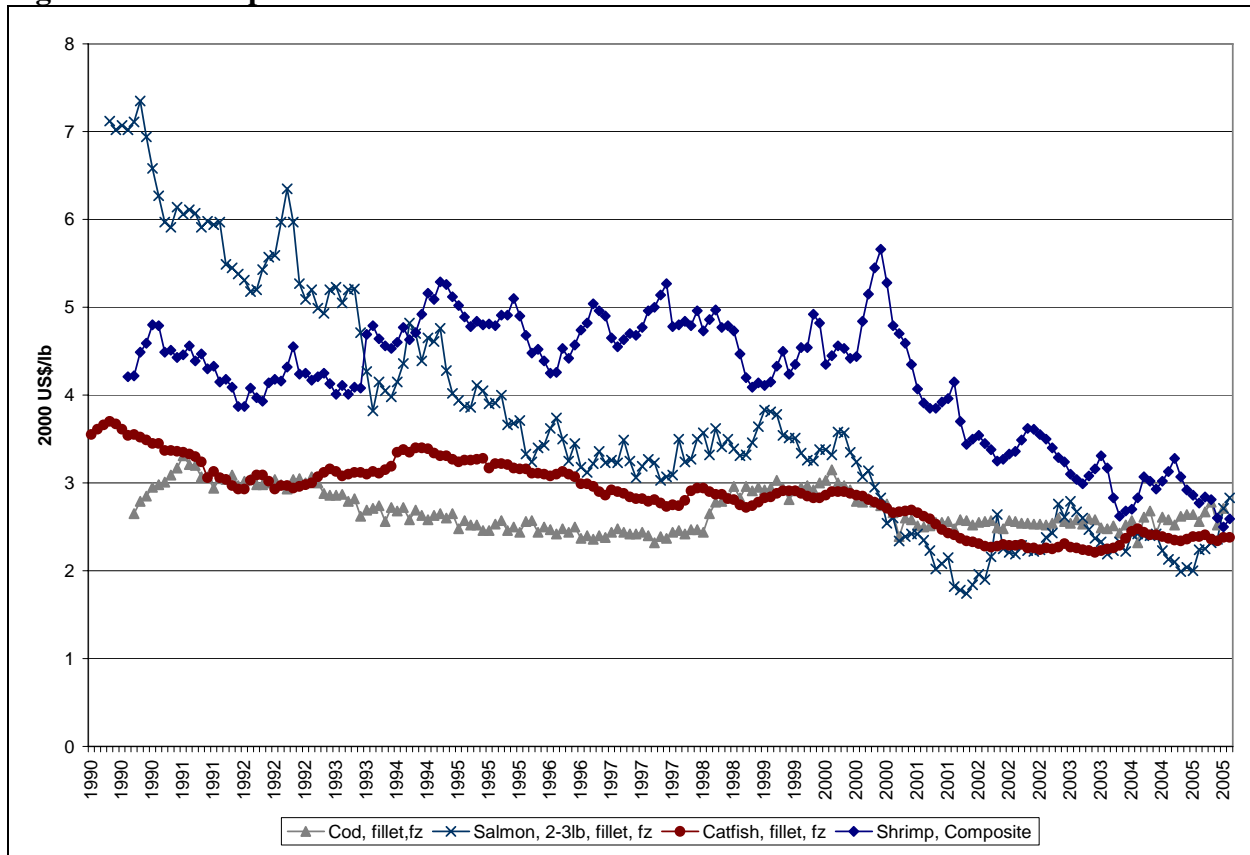
In addition to increasing global seafood supplies, the aquaculture sector also provides seafood markets with characteristics that traditional fisheries are often unable to provide. Aquaculture species are often not as influenced by seasonal and environmental fluctuations in supply, unlike wild fisheries (such as wild-caught salmon) which have season-specific supply spikes, followed by periods of no availability. This consistency in the supply of a species is preferable to processors and distributors, who can make production and marketing decisions throughout the year instead of over a concentrated period of time. Consumers also benefit from year-round availability of a species, allowing demand to grow as consumption becomes more frequent. In aquaculture, product forms do not have to be limited to frozen, as is often the case for many wild fisheries. Furthermore, year-round trade in fresh or live species is also possible for several species.

Given the standardized production of aquaculture species, producers are able to supply a homogeneous product of similar size, quality, and consistency throughout the year. For example, a catfish fillet harvested and sold in March is essentially identical in size and quality to a catfish fillet sold in December, owing to consistency in the production process. Processors, distributors, consumers, and the market all benefit from this reliability in supply, quality, and form. Another important feature of aquaculture is the ability to predict supply with a much lower variance than is the case in wild, traditional fisheries.

The consistency in supply and quality of aquacultured products are essential features for market development, especially with regard to new and value-added products. Investors and marketers will seek out species that exhibit increasing production trends, where, as demand grows so too can supply—further increasing market demand.

## **Real Price Trends in Seafood**

The real price trends of various aquaculture species have been declining over time in contrast to traditional wild-caught species, which have remained essentially flat or increased (Figure 11.7). Over the past 15 years, the real price of frozen cod has remained relatively unchanged. During 1990, the average price of frozen cod was \$2.84 per pound, while in 2005 the average price was \$2.65 per pound, a 7% difference. In contrast, the real prices for salmon, shrimp, and catfish all fell considerably over that same time period. Salmon prices declined 66%, falling from an average price of \$6.94 per pound in 1990 to an average price of \$2.39 per pound in 2005. The price of shrimp declined from an average price of \$4.52 per pound in 1990, to an average price of \$2.71 per pound in 2005, representing a decline of 40 percent. Similarly, the price of frozen catfish fillets declined 33%, from an average price of \$3.57 per pound in 1990 to an average price of \$2.38 per pound in 2005. It is also interesting to note that, currently, catfish, shrimp, salmon, and cod are all trading at very similar prices. Relatively consistent declines in the price of aquacultured products are important, because they create opportunities for market development and increased market share.

**Figure 11.7. Real price trends of seafood.**

Source: USDA, 1990-2005; Urner Barry Publications, 1990-2005

### Product Diversification and the Role of Eco-labeling

Relating back to Table 11.1, as the number of species consumed becomes fewer and the market becomes more concentrated, diversity in product attributes will fuel additional market growth. As stated earlier, this can come in the form of new preparations, sauces, flavorings, and other value-added consumer conveniences. Another important source of product differentiation will come from eco-labeling and other types of certification programs that differentiate products according to set standards that relate back to environmental, health, or other relevant production methods.

There are two major marine certification programs: one administered by the General Aquaculture Alliance (GAA), and one administered by the Marine Stewardship Council (MSC). The GAA strictly deals with aquacultured species. According to its website, the GAA is “an international, nonprofit trade association dedicated to advancing environmentally and socially responsible aquaculture” (GAA, 2006). The GAA established the Responsible Aquaculture Program (RAP), which led to the establishment of quantitative, “Best Aquaculture Practices” standards for shrimp farming. These standards address environmental and social issues in addition to food safety and traceability issues (GAA, 2006).

Another important certification program, the MSC, deals strictly with traditional capture fisheries. Established through a partnership between Unilever and the World Wildlife Fund (WWF), the MSC was developed to create standards for certifying fisheries as sustainable and well-managed (MSC, 2006). There are three main principles of the MSC standard: 1) the condition of the fish stock is evaluated, ensuring harvest levels are sustainable; 2) the impact of the fishery on the surrounding marine environment is examined (including the potential impact on non-targeted species, marine mammals, and sea birds); and finally, 3) the fishery management system is evaluated to assess the success of its rules and procedures in ensuring the sustainable use of the resource (MSC, 2006). Currently, the MSC does not certify aquacultured fish; however, it is reasonable to envision the MSC expanding to include both traditional fisheries and aquaculture in the future.

Both certification programs provide another form of value-added product differentiation to consumers by providing information on the production and harvest practices and, also, the overall environmental and social impacts of a given fishery. Consumers are becoming increasingly interested in where and how their seafood was produced or harvested, and the value of this information has not been lost on retailers and restaurants. Both Wal-Mart and Darden restaurants have recently committed to providing MSC- and GAA-labeled products to its consumers. In early 2006, Wal-Mart announced its commitment “to source all of its wild-caught fresh and frozen fish for the North American market from MSC certified fisheries over the next three to five years” (Wal-Mart, 2006). This commitment will apply to Wal-Mart’s own branded products, not other branded products, although the company hopes “to influence that also” (McGovern, 2006). Darden Restaurants Inc., the parent company of Red Lobster, recently committed to requiring its farmed shrimp suppliers to adhere to GAA “Best Aquaculture Practices” certification standards. Both companies are major players, and their actions speak volumes about the growing importance of environmental certification programs. Other retailers and restaurants will most likely follow the lead of Wal-Mart and Darden, increasing both the availability and popularity of this new form of value-added seafood product in the market.

Roheim (2003) identifies four major beneficiaries of successful eco-labeling programs. First, marine fisheries and surrounding ecosystems benefit from the establishment of sustainable management practices. Second, consumers benefit from receiving more information on the seafood products which they consume, allowing them to make more informed purchasing decisions. Third, producers of eco-labeled seafood products benefit from potentially higher prices, due to the ability to differentiate their products. And finally, the fishing industry itself benefits from operating in a sustainable and well-managed framework designed to preserve both the resource and the industry.

## **Conclusions**

The general trends shaping the future of the U.S. seafood industry are increasing imports predominantly from the aquaculture sector: moderately increasing per capita seafood consumption, and growth in value-added seafood products. The U.S. demand for seafood is forecasted to expand by 25-35% over the next 15 years, with no foreseeable increases in domestic production, especially from domestic capture fisheries. The situation is similar for global capture fisheries, many of which are already fully exploited. Therefore, any further

increases in total global fisheries production will come from the aquaculture sector, as has been the case to date.

Per-capita consumption of seafood will continue to increase; however, it will likely be concentrated on fewer species produced primarily through aquaculture. Product diversity will come from variations in preparation, including sauces, portions, and other value-added and convenience-driven modifications. Additionally, eco-labeling and other certification programs will provide further opportunities for value addition and product differentiation.

Technological innovations and better nutritional and disease management practices will continue to reduce costs in aquaculture production. In turn, lower production costs and increased supplies from aquaculture will hold prices down, another attractive outcome for investors and marketers. However, the trend toward value-added products has the potential to drive processing to countries where labor costs are lower.

Retail outlets will continue to be increasingly important to the seafood industry. Supply stability and product standardization are important attributes for large retailers and chain restaurants, especially those focused on growth in revenue and market share. They will seek out new product forms that have the potential to expand both on the supply and the demand sides. Furthermore, they will seek out supply sources where consistency and low prices allow them to engage in long-term planning. Given these requirements, aquaculture is in a better position to satisfy these demands than traditional capture fisheries.

Open-ocean aquaculture has the potential to contribute in two major ways. First, it would increase the global supply of seafood by providing an additional source of production. Recall that global demand for seafood is expected to grow 38 percent between 1999/2000 and 2015. Additionally, open-ocean aquaculture can provide a product that meets the needs of consumers and processors: a consistent, high-quality product with a relatively stable and/or declining price.

With regard to the United States, seafood imports will remain vital in bridging the gap between domestic supply and demand. While the emergence of a domestic, open-ocean aquaculture industry has the potential to increase domestic seafood production, it will not eliminate seafood imports. However, without any increases in domestic aquaculture production, offshore or otherwise, the level of seafood imports will have to increase to meet an ever-growing domestic demand for seafood products. In 2004, the U.S. seafood deficit was \$7.6 billion, an all-time high (NMFS, 2004). Without substantial increases in domestic production, the seafood trade deficit will certainly increase. In the future, aquaculture will be the primary source of growth in seafood supply for the U.S. market. U.S. regulatory policy over the aquaculture sector will largely determine whether that source is from domestic or foreign production.

## References

Anderson, J.L. 2003. *International Seafood Trade*. Woodhead Publishing, Ltd., Cambridge, England and CRC Press, Boca Raton, Florida.

Connor, William E. 2000. Importance of n-3 fatty acids in health and disease. *American Journal of Clinical Nutrition* 71:171S-175S.

Delgado, C.L., N. Wada, M.W. Rosegrant, S. Meijer, and M. Ahmed. 2003. Fish to 2020: Supply and Demand in Changing Global Markets. International Food Policy Research Institute, Washington DC. World Fish Center, Penang, Malaysia.

Eliseo Guallar, M. Inmaculada Sanz-Gallardo, Pieter van't Veer, Peter Bode, Antti Aro, Jorge Gómez-Aracena, Jeremy D. Kark, Rudolph A. Riemersma, José M. Martín-Moreno, Frans J. Kok, the Heavy Metals and Myocardial Infarction Study Group. 2002. Mercury, Fish Oils, and the Risk of Myocardial Infarction. *New England Journal of Medicine* 347:1747-1754.

Food and Agriculture Organization (FAO). 2006. FishStat Plus: Universal Software for Fishery Statistical Time Series.

Global Aquaculture Alliance (GAA). 2006. <http://www.gaalliance.org/resp.html>

Kris-Etherton, P. M. Harris, W. S. Appel, L. J. 2002. Fish consumption, fish oil, omega-3 fatty acids, and cardiovascular disease. *Circulation* 106(21):2747-57.

Kromhout D, EBBosschieter EB, de Lezenne Coulander C. 1985. The inverse relation between fish consumption and 20-year mortality from coronary heart disease. *New England Journal of Medicine* 312:1205–1209.

Marine Stewardship Council (MSC). 2006. <http://www.msc.org/>

McGovern, D. 2006. *Wal-Mart Clarifies MSC Initiative*. Intrafish Media. <http://www.intrafish.no/global/news/article100353.ece>

National Fisheries Institute (NFI). 1988 & 2005. Top Ten Seafood Rankings Provided by Howard Johnson, H.M. Johnson & Associates for NFI. <http://www.aboutseafood.com>

National Marine Fisheries Service (NMFS). 2004. Fisheries of the United States 2003. U.S. Department of Commerce, National Oceanic and Atmospheric Administration, National Marine Fisheries Service, Office of Science and Technology, Fisheries Statistics Division.

Perkins, C. 1994. Seafood Business Retail Survey: U.S. Retail Sales. Seafood Business. Diversified Business Communications. Portland, Maine

Robinson, F. 2004. Seafood Business Retail Survey: U.S. Retail Sales. Seafood Business. Diversified Business Communications. Portland, Maine

Roheim, C. 2003. Chapter 10 in International Seafood Trade. Anderson, J.L. 2003. Woodhead Publishing Ltd., Cambridge, England and CRC Press, Boca Raton, Florida



Seierstad, S.L., Seljeflot, L., Johansen, O., Hansen, R., Haugen, M., Rosenlund, G., Froyland, L. and H. Arnesen. 2005. Dietary Intake of Differently Fed Salmon: The Influence on Markers of Human Atherosclerosis. *European Journal of Clinical Investigation* 35(1):52-59.

United States Department of Agriculture. National Agricultural Statistical Service (USDA NASS). 1990-2005. Catfish Processing.  
<http://usda.mannlib.cornell.edu/reports/nassr/other/pcf-bb/>

United States Department of Agriculture. Economic Research Service. (USDA ERS). 2004. Per Capita consumption data.  
<http://www.ers.usda.gov/data/foodconsumption/FoodAvailSpreadsheets.htm>

United States Department of Commerce (USDC). 2005. US Census Bureau. US Imports and Exports of Merchandise. Washington, DC.

Urner Barry Publications. Seafood Price-Current. 1990-2005.

Wal-Mart. 2006. News Release. Wal-Mart Takes Lead On Supporting Sustainable Fisheries: All Wild-Caught and Frozen Fish Suppliers to be Marine Stewardship Council-Certified.  
<http://walmartstores.com/>

*This page intentionally left blank.*

## CHAPTER 12

### Broader Issues in the Offshore Fish Farming Debate

John Forster

---

*Previous chapters have been concerned primarily with the immediate and near-term implications of offshore aquaculture, such as markets, jobs, costs, and competition. This chapter looks at its potential over the longer term and within a broader context by asking:*

- *How does the potential of offshore aquaculture fit into the bigger picture of global food supply?*
- *What is its long-term potential and how important is this potential in evaluating today's efforts to get started?*
- *Since it is impossible to satisfy humanity's need for food with zero impact, how should offshore aquaculture be judged in comparison to other methods of food production?*
- *What new law, if any, is needed to enable private farming in marine public lands?*

#### **The Global Food Supply**

Discussion of the above questions becomes more meaningful when key points about global population and food supply are first understood: For example:

- Annual world food production in total is about 5.1 billion metric tons (Table 12.1).
- At least 1.1 billion tons (21%) of this food is fed to animals (Wild 1997)<sup>1</sup>.
- Production of terrestrial animal products is 473 million metric tons (mmt) per year.<sup>2</sup>
- Capture fisheries yield about 93 mmt of fish per year<sup>3</sup> (Figure 12.1).
- Aquaculture produces 42 mmt fish and shellfish per year, and 1.9 mmt of seaweed

Looking ahead, the FAO (2002) has projected that:

- World population will grow from about 6 billion people to 8.3 billion by 2030;
- Food calories available per person will increase from 2,800 kcal to 3,050 kcal;
- This means one billion metric tons more cereal crops will be needed for human and animal food; and
- 120 million hectares more farmland will be needed to grow these cereals.

FAO and other researchers also project that there will be an increase in per-capita consumption of meat and dairy products, which will be driven by higher per-capita incomes in

---

<sup>1</sup> This figure is from a 1997 report. There are more up to date figures for the manufactured feed sector, but this is the only source the author could find that included all feeds, i.e. manufactured feeds (530 mmt), home mixing (350 mmt) and single ingredient feeds (220 mmt). Tacon (2005) quotes Gill (2005) in stating that manufactured feed production is now 620 mmt.

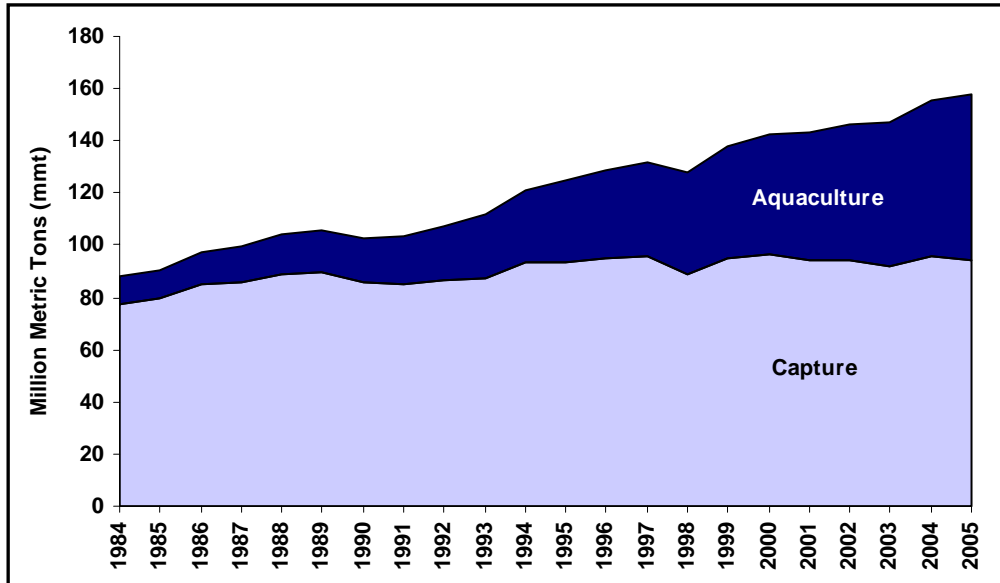
<sup>2</sup> This includes a 'constructed value' for milk of which there is 600 mmt produced each year. When expressed on a equivalent protein basis with meat using data from Waggoner (1994), this converts to 169 mmt.

<sup>3</sup> 68.3 mmt of which is eaten by humans and 21.7 mmt is made into fish meal.

**Table 12.1. Agricultural production in 1990.**

<i>Product</i>	<i>Production (mmt)</i>	<i>Protein (mmt)</i>
<b>CLASS 1</b>		
<i>Wheat</i>	601,723	84,162
<i>Rice</i>	521,703	46,953
<i>Veg &amp; melon</i>	450,986	4,669
<i>Fruit ex melon</i>	344,875	2,811
<i>Potatoes</i>	268,107	4,547
<i>Cassava</i>	150,768	897
<i>Sweet potatoes</i>	125,124	1,709
<i>Sugar</i>	123,401	0
<i>Pulses</i>	58,846	13,117
<i>Rye</i>	40,042	5,606
<i>Rapeseed</i>	24,416	8,320
<i>Ground nuts</i>	23,410	4,440
<i>Sunflower</i>	22,682	7,729
<i>Yams</i>	20,966	379
<i>Copra</i>	5,476	394
<i>Taro</i>	5,173	82
<i>Tree nuts</i>	4,379	198
<i>Roots other</i>	3,971	54
<i>Cocoa beans</i>	2,528	437
<i>Sesame</i>	2,399	817
<i>Olive oil</i>	1,573	0
<i>Honey</i>	1,172	4
<i>Safflower</i>	917	312
<b>TOTAL</b>	<b>2,804,637</b>	<b>187,637</b>
<b>CLASS 2</b>		
<i>Milk</i>	537,844	18,836
<i>Meat</i>	176,629	26,222
<i>Fish</i>	99,535	24,585
<i>Eggs</i>	37,056	4,252
<b>TOTAL</b>	<b>851,064</b>	<b>73,895</b>
<b>CLASS 3</b>		
<i>Corn</i>	479,340	47,934
<i>Barley</i>	181,946	23,653
<i>Soybeans</i>	108,134	36,847
<i>Sorghum</i>	56,677	6,234
<i>Oats</i>	42,799	5,564
<i>Cotton Seed</i>	33,930	11,562
<i>Millet</i>	29,896	3,569
<b>TOTAL</b>	<b>932,722</b>	<b>135,363</b>
<b>GRAND TOTAL</b>	<b>4,588,423</b>	<b>396,895</b>

Note: More up-to-date data from various sources indicates that current world food production is more than shown here by about 500,000 mt. Data from Waggoner (1994) is used here because it is the only data that could be found that expressed global production in terms of weight and protein.

**Figure 12.1. Global seafood production from wild-capture fisheries and aquaculture.**

Source: FAO, 2007

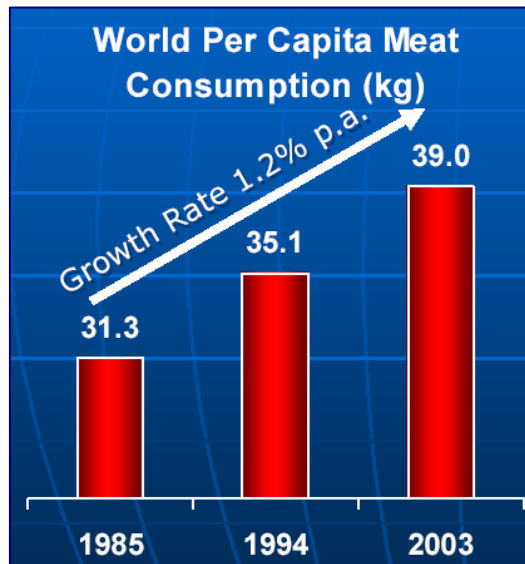
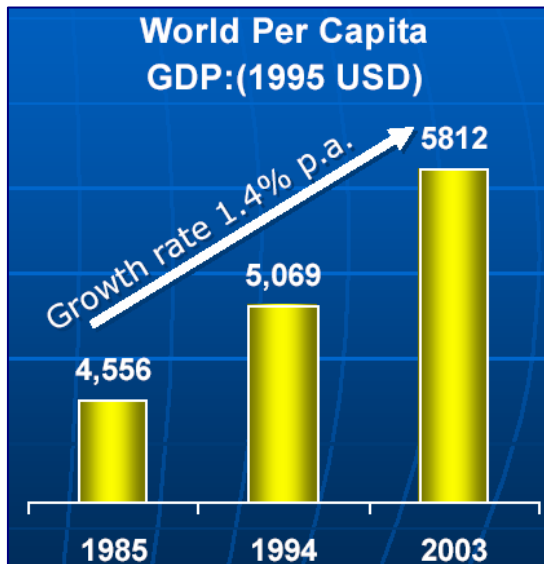
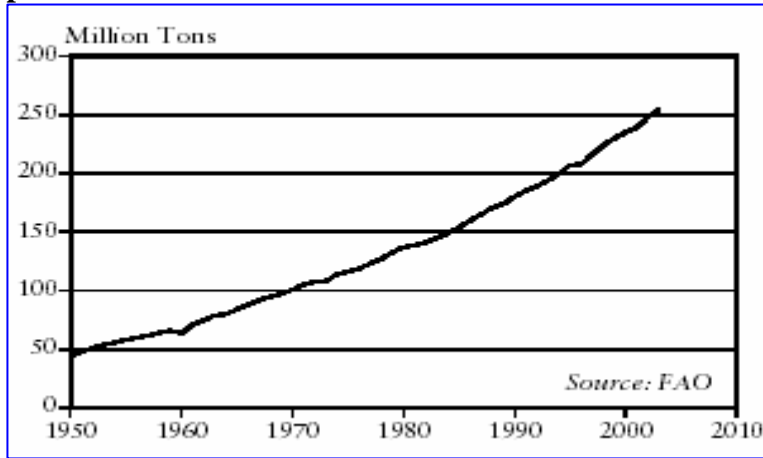
developing countries (FAO, 2002; Brown, 2005; Delgado et al., 1999) (Figure 12.2). Consumption of meat and milk by 2030 is expected to increase by 100 mmt and 223 mmt, respectively, led by China, which already consumes over twice the amount of meat eaten in America (Delgado et al., 1999; Brown, 2005). Delgado et al. (1999) also warn that unless increased production is accompanied by corresponding improvements in farming practices, it will result in continued environmental degradation including, importantly, continued diminution of fresh groundwater reserves.

These projections highlight the huge difference in the scale of production between what is anticipated by traditional agriculture and what might be feasible during the same period from offshore aquaculture. It is sobering to realize, for example, that just the expected increase in global meat supply between 1993 and 2030 is more than the present, total worldwide production of all seafood from capture fisheries and more than twice that of aquaculture. By comparison, the likely contribution from true offshore (open-ocean) aquaculture by 2030 will be modest. Presently, it contributes no more than about 20,000 mt per year worldwide<sup>4</sup> and, unless things go exceptionally well, this is unlikely to increase to more than 2 mmt by 2030, or by just 2% of the expected increase in meat supply. This does not mean it will never be more significant, but to reach its full potential, development of offshore aquaculture will take more than 25 years.

Under these circumstances, Delgado et al. (2003) conclude that prices for seafood, relative to other kinds of meat, will rise by about 20%. The primary driver for this increase will be demand in developing countries, which will occur because capture fisheries have reached the limit of what they can take from the oceans, while aquaculture is unlikely to be able to make up

<sup>4</sup> This estimate does not include 'nearshore' or sheltered water farming such as for salmon. It includes farmed tuna and limited quantities of other marine fish that are now being farmed in exposed open ocean (offshore) conditions.

**Figure 12.2. World meat production and the historical relationship between wealth and meat consumption .**



Sources: Brown, 2005, Bunge, undated

the gap. Moreover, demand for certain food crops to produce biofuel is now leading to price increases in a broad spectrum of food products worldwide. When superimposed on the outlook for seafood, this suggests even larger future seafood price increases as well as higher feed costs for those who grow any sort of livestock.

One final point that these numbers highlight is the vast disparity that exists between the amount of food derived from the land versus that captured from the sea. Presently, worldwide consumption of all animal products is 566 mmt per year<sup>5</sup>, of which the oceans contribute only 12.1%<sup>6</sup> from capture fisheries and less than 1% of our plant-derived food or fiber. Yet they cover over two-thirds of the Earth's surface and contain 97% of its water, and their natural productivity

<sup>5</sup> Total of 473 mmt of terrestrial animal products which, as noted in Footnote 2 of Page 1 (this chapter), includes a constructed value for milk protein, plus 93 mmt of seafood.

<sup>6</sup> 68.3 mmt of wild caught seafood was eaten by humans in 2003. This is 12.1% of the 566 mmt total.

is thought to be similar to that of the land, namely 40 to 50 petagrams<sup>7</sup> (Pg) of carbon per year compared to 56 Pg per year on land (Geider et al., 2001). At a time when the world faces the prospect of having to produce large amounts of additional food by traditional agriculture, adding environmental burden to what is already thought to be excessive (UN, 2005), it is appropriate to ask: Is increased production of food from the oceans a possible solution and, if it is, what has to be done to accomplish it?

## **Offshore Aquaculture in the Long Term**

### *Making More Productive Use of the Sea*

The potential for offshore aquaculture in the long term may be larger and more profound than merely providing additional production to meet our future needs for seafood. Our biosphere is powered by energy received from the sun, two-thirds of which falls on the oceans. In turn, the oceans provide equable growing conditions for plant life over their entire surface, resulting in an overall level of productivity already comparable to that on land when, as yet, no serious attempt has been made to enhance it. Moreover, this productivity and its potential enhancement are not dependent on inputs of freshwater as is terrestrial agriculture, a dependency that may inhibit its expansion in some areas. The key to recovering more of this energy and to making the oceans more productive is to develop a system of aquaculture that grows plants as its primary source of production, with animal protein being produced secondarily, just as is done in terrestrial agriculture today.

For reasons explained below, it will take many decades and much experimentation before methods are perfected to be able to do this. Marine aquaculture, as practiced today, is simply a first stage in this process, and it is important that it is seen in this context because it is too easy, otherwise, to misinterpret it and to under-estimate the environmental and economic benefits it will bring. For the same reason, it is also important to start thinking about what might be involved in a plant-based “Marine Agronomy,” in order to help guide a development process that could not only ease pressure on our natural fisheries but could, eventually, reduce the demands we now make on the land and even on the biosphere itself. At a time when the prospect of global warming threatens human existence as we know it, it is surely an oversight that we use two-thirds of the Earth’s surface for little more than hunting and navigation.

Though agricultural parallels are persuasive, their application at sea is difficult, because terrestrial and marine ecosystems are quite different. While vegetation on land is dominated by large plants (macrophytes), plant life in the oceans consists mainly of microscopic plants, collectively called phytoplankton. Large marine plants (seaweeds) make up only a small proportion of total marine vegetation, because most seaweed species need to attach to a surface; normally the seabed. In order to do this and yet still receive enough light, they must occur in shallow water. Most of the ocean is too deep for them, so phytoplankton species - which can float near the surface in order to receive light - are the only plants that can grow there.

These tiny plants are the primary food source for higher animals, but they cannot be eaten directly by most fish and, instead, must first be consumed by small, filter feeding creatures specifically adapted for such a trophic existence. In turn, these creatures serve as food for larger

---

<sup>7</sup> One petagram = 10 to the power of 15 grams.

fish, some of which are captured in commercial fisheries, but which mostly provide forage for still larger fish that are then targeted for capture. Thus, the “marine food chain” requires one, two or more additional conversion steps compared to the process on land before producing animals that can be readily used by man. It means that most of the fish taken in capture fisheries, or contemplated as species for aquaculture, are carnivores, quite unlike the large macrophyte-eating herbivores that provide meat for humans on land.

There are exceptions to this; especially, bivalve shellfish that can filter and feed on phytoplankton and which humans are able to harvest directly. Future, large-scale ocean aquaculture could produce more shellfish for this reason. But there is probably a limit to how many mussels, oysters, or clams people can or want to eat. Mostly, humans prefer to eat fish and there are few species of fish suitable for farming, or palatable to humans, that can filter phytoplankton or eat seaweed. Therefore, a critical step in realizing the full potential of ocean farming is to figure out how to “shortcut” the natural marine food chain by processing protein and fat from marine plants so that they can be used in fish feed. Or, at least, to find uses for farmed marine plants that substitute for terrestrial ingredients in other applications. Unless this is done, fish farming will, in effect, be a “zero sum game” in which ingredients that might otherwise be fed to terrestrial animals are fed to fish instead. It is true that fish may convert these ingredients into meat more efficiently than warm-blooded land animals and that the meat itself may be of superior nutritional value, so the sum may not be exactly zero. But, the accomplishment will be so much greater if we can truly learn to amplify and harvest some of the ocean’s vast photosynthetic capacity.

#### *Seaweeds for biofuel and animal feed*

Increased food production is not the only way in which humanity might benefit. World energy use is expected to increase five-fold by 2100 (Huesemann, 2006). Given that peak oil production will soon be reached and that the continued combustion of fossil fuels will aggravate the many risks associated with global climate change, it is imperative that future energy demand be supplied by renewable energy. However, the generation of biofuels such as ethanol, diesel, and methane from terrestrial biomass requires extremely large areas of productive land. For example, to supply the current worldwide energy demand of 351 Exajoules ( $10^{18}$  joules)/yr solely with terrestrial biomass would require more than 10% of the earth’s land surface, which is comparable to the area used for the entire world arable agriculture; about 1,500 million hectares. Or, if ethanol from corn were to be substituted for 100% of the gasoline consumption in the U.S., all of the available U.S. cropland (190 million hectares) and the freshwater that irrigates it would have to be devoted to ethanol production, leaving no land for food production (Huesemann, 2006). Since the oceans are not used presently for any form of large-scale capture of solar energy by photosynthesis, it prompts the question: Could this be possible one day, and if so, could the resulting biomass be used for a wide range of applications, including biofuel production, thereby easing pressure on the land?

This idea was first examined in the early 1970s following the first world oil crisis when the U.S. Department of Energy and the Gas Research Institute established a marine biomass energy research program to determine the potential for producing methane from seaweed by a process of biodigestion. After conducting several pilot studies and feasibility analyses, Ashare et al. (1978) concluded that the concept was not then economically competitive, a conclusion that



was validated later as crude oil prices declined in the early 1990s. But oil and gas prices are now back at record highs and the prospect of carbon taxes makes it likely that burning them will become even more expensive in future. A recent analysis of the past work (Chynoweth et al. 2001) suggests that methane production from seaweed such as *Macrocystis*, *Sargassum*, and *Laminaria* could now be economically viable if methods can be developed for the large scale farming of these species. Viability might be even more likely if these plants could also be processed into products such as animal feeds as well as biofuel, as is the case in ethanol production from corn.

It is easy to dismiss such notions as fantasy. Certainly, the prospect of large scale farming of seaweeds for energy and animal feed is many years away but, as we learn to farm fish and to work in the open sea, so we will develop the skills and infrastructure that will allow us to farm marine plants there in future. And, as we learn to feed carnivorous fish on terrestrially grown plant nutrients, so we will set the stage for them to be fed, one day, on plant nutrients produced at sea.

In effect, today's pioneering aquacultural efforts are just the beginning of the creation of a critical mass around which new developments can take place, some of them barely imaginable now. The key to making progress, as it has always been, is to try, to risk failure and to learn from it. In a twenty-first century capitalist democracy, that also means trying something that has a chance at the outset of making some money and, for now, that means growing something for which people will pay a price that justifies the costs, and that means high value finfish. If we can embrace that idea and build research programs around it that anticipate subsequent steps in the journey, there is a reasonably good chance that it will get us, eventually, to where we need to go.

It is noteworthy that one of the companies that collaborated in the earlier marine biomass work was General Electric, which now, alongside other, international corporations, champions "green energy" production as one of the outstanding economic opportunities for American business in the new century. As in the offshore production of finfish, America possesses many of the technologies necessary to develop new, renewable energy and food sources based on the farming of marine plants. That such an opportunity is apparent at the same time as the offshore production of more seafood is contemplated is no coincidence. The Millennium Ecosystem Assessment (UN, 2005) describes all too clearly how the Earth, especially its terrestrial habitat, is strained to its breaking point. And though the assessment provides similar warnings about world fisheries and coastal pollution, it is not surprising that people from many fields find themselves wondering simultaneously if two-thirds of the planet could be used more effectively.

### First Steps

The Chinese philosopher, Lao-Tzu, once observed that a journey of a thousand miles must begin with a single step. Relative to the lofty goals put forward above, modern marine aquaculture has a long way to go and has, up to now, taken just a few tentative, albeit critical, steps for which it is often criticized. Salmon farming has born the brunt of much of the criticism. Yet, in the space of only 30 years it has become the world's primary source of salmon and proved to a skeptical seafood industry that it is possible to turn to the sea and farm high-quality fish at a cost that meets the value expectations of a mass market. In so doing, it has made highly nutritious food available to many who would otherwise have been deprived of its benefits.

Of course, methods of salmon farming and the farming of other species can be improved. But these improvements would hardly be possible, or even contemplated, were it not for what was learned during the past few decades. Steady, incremental improvements in a technology may not satisfy idealists, but man has always progressed in this way and there is no reason to think that the development of ocean farming - be it for seafood, renewable energy, or other valuable byproducts - will be different. This is one of the reasons that the U.S. Commission on Ocean Policy and a wide variety of stakeholders have recommended the enactment of offshore aquaculture legislation: to enable the next steps in the process (NOAA, 2007; Cicin-Sain et al, 2005; Stickney et al, 2006). If America is to take the lead in this new industry, as it can and should, it is essential to provide a regulatory framework now that will allow a period of experiment and innovation to begin.

What can be expected?

If an initial timeframe of ten years is contemplated, what sort of projects can be envisioned, what will they look like, and how much space within the EEZ will be needed? Ten years is not very long in a business with production cycles from egg to harvest up to three years, so it is unlikely that within such time passing of legislation will unleash massive growth. The technical challenges and assembly of all the components needed to make medium to large scale offshore aquaculture business work are complex, so initial investment is likely to be cautious and painstaking. But it will lay the groundwork for further expansion and provide a more informed basis for further legislation should it be found that such is needed. The sorts of development that can be expected may include:

- Demonstration that offshore farming systems can be operated economically over several years in a wide range of sea conditions;
- Establishment of up to 20 new offshore farms in the U.S. EEZ, with a combined annual production of 10,000 to 15,000 mt;
- Identification of up to ten different species of fish as suitable candidates for offshore aquaculture;
- Establishment of up to five onshore hatcheries to produce juvenile fish to be stocked in offshore farms;
- Establishment and gradual expansion of offshore methods for the production of mussels and possibly scallops; and
- Research on techniques for farming and processing certain seaweeds, and on development of applications and markets for them.

It is important that this likely pace and nature of progress is understood clearly. To put it in perspective, an offshore aquaculture industry of 20 farms producing a combined total of 15,000 mt of fish per year would need about 30 acres of surface space in the EEZ for net pens, with up to 2,000 acres encumbered by moorings on the seabed (out of the 25 billion acres of the U.S. EEZ).

Looking ahead further, there are several directions the industry may take. Which of them will be followed and how quickly development proceeds will depend on the success of research and on markets as they evolve, but the following are some possibilities:

- Combined aquaculture and offshore wave or wind energy systems that tap the synergies created by supporting infrastructure and by wave attenuation in the case of wave energy;
- Location of farms in deeper water as single point mooring methods are perfected or self-positioning systems are developed that can be operated at any depth;
- Refinement in the understanding of how nutrients can be recycled from fish farms by integration with shellfish or seaweed farms;
- Adoption of offshore mussel farming (as in New Hampshire) and small finfish cage culture technologies by commercial fishermen using existing boats and supply high value niche markets; and
- Development of methods for the floating culture of seaweeds combined with genetic improvements in them like those that made the “green revolution” in terrestrial agriculture possible, yielding biomass of increasingly high value for a range of new applications, including renewable energy.

Such developments may herald a completely new method of energy and food production that could, one day, free humans from the limits of the land and allow some of the land itself to be taken out of production. This will not happen in committees, or through desk studies, but by learning-by-doing, through the hard work of pilot and demonstration projects, fledgling commercial operations, and by cooperative work of fishermen, entrepreneurs, scientists, and seafood businesses.

*How sustainable is it and how should this be judged?*

The long-term vision for ocean farming offered above would seem to meet all current definitions of “sustainable” since farming would be predominantly powered by sunlight. However, as noted, there is a long way to go before the vision will become reality. How, therefore, should sustainability be judged in the interim? In fact, how can the sustainability of any process be judged when it is not static but constantly adapting to change? Critics frequently brand some forms of modern marine aquaculture as unsustainable, notably salmon farming. But is this meaningful, or helpful, if such activities are a means to an end that will be quite different from the way they operate today?

Three presumptions seem to underlie the criticism. First, that there is little difference between fisheries, which depend on nature to adapt to and recover from human pressure, versus fish farming, where “nurture” allows man to intervene to accelerate the process using technology. An editorial in the February 9, 2006 *Seattle Times*, “Don’t throw more krill on the barbie,” captured this idea. Second, aquaculture will continue to expand unchecked by ecological or market forces. Third, the industry cannot be trusted to improve on its own. Yet the industry has been undergoing constant and rapid improvement for the past 30 years in response to ecological, market, and regulatory forces. By any standard, it is more efficient now than it was 30 - or even 10 - years ago, both economically and ecologically. And while regulatory coercion played a part, competition, smart design to save on costs, and rising prices of inputs such as feed costs, have been by far the greatest forces for change.

A frequently cited criticism, which embraces elements of all three presumptions, is that the use of fish meal in salmon feeds is unsustainable because fish meal fisheries are fished to their limit and cannot supply more. Further, it is argued that salmon and most marine fish are carnivores and that feeding them with fish is like feeding tigers with meat and leads to a net loss of fish protein (Naylor, et. al., 2000). The counter-points to this are listed below; each speaks in a different way to why these criticisms and the resulting charge of lack of sustainability are misleading.

1. Up to one-third of fish meal is made from fishery wastes that would have to be disposed of if not re-used as animal feed.
2. The other two-thirds are made mostly from small bony fish that are caught in mostly well-managed fisheries and for which man has not yet found a better use. In fact, implied in much of the criticism on this issue is the idea that using these fish for fish meal production deprives malnourished people from being able to eat them instead. This is highly misleading because it has proved impossible up to now, despite considerable effort, to process them into a form that is palatable to people at a cost that makes sense.
3. Feeding salmon with some fish meal in their diet is actually up to five times more efficient than if the fish from which the meal is made were left in the sea to be eaten by wild fish (Asgard et al., 1999). Thus, the idea that use of fish meal in aquaculture results in a net loss of fish protein is also misleading.
4. The comparison with feeding tigers overlooks the fundamental differences between marine and terrestrial ecosystems (explained earlier) and the last two points made. The great majority of fish that humans eat are carnivores, but whereas for commercially-caught wild fish this can never change, in aquaculture it can and will. Indeed, changes are already happening (see #6 below).
5. Because an animal has adapted to catch and eat other animals in nature does not mean that its digestive system is incapable of using vegetable matter, especially if the protein in this matter has been concentrated (Rust, 2002). Thus, in captivity carnivores can in effect be turned into herbivores. There is still much to learn about doing this with many potential aquaculture species, but carnivorous behavior in nature is not an immutable physiological state.
6. Salmon farmers and farmers of other carnivorous fish have realized for years that the supply of fishmeal is finite and that this represents a commercial vulnerability. Research to find alternatives has been progressing since the 1970s, and ingredients such as soy, corn, and canola protein are already being used in salmon feeds at increasing rates of inclusion.

In a broader context and building on what has been learned in the last 20 years, most people would say that commercial offshore aquaculture was not only sustainable, but highly beneficial if, 25 years from now, it becomes an industry that:

- contributes one mmt (\$2.5 billion) of domestically-produced seafood to the national larder;
- demonstrates that it really is a means to reduce pressure on over-fished stocks;

- is well on its way to perfecting ecologically balanced aquaculture that recovers wastes from fish farms through secondary production of shellfish and seaweeds; and
- uses feed made from all vegetable proteins or byproducts from other agribusinesses, while developing methods for making feeds directly from seaweed proteins.

And, while some may challenge that controlled recycling of fish farm wastes in an ocean environment is improbable, it is not so very different from the concepts of organic agriculture today, where farm animals are nourished with feed that is grown in fields nearby using animal wastes as the primary source of nutrients. A major difference between the two is that, on land, such wastes have to be collected, transported and spread, using non-renewable energy for a process that at sea is performed passively. Given the vastness of the oceans and with careful siting of aquaculture operations, aquaculture could transform man's present understanding of the Earth's productive capacity and possibly reduce the burden he currently imposes on its exhausted lands.

### Environmental Costs

Some of the discourse about marine aquaculture is focused upon concerns about actual or hypothetical environmental impacts. It is suggested, however, that it would be better instead to talk about environmental costs or the use of environmental services. Man could not survive without incurring such costs or using such services, and it is hardly surprising that the costs imposed by six billion people (soon to be eight billion) appear to be pushing the environment toward bankruptcy—consumption of food being one the main drivers. Yet no one suggests that humans should not eat, so the only solution, if there is one, is to seek to minimize the costs incurred or services used in producing what we need.

This raises two points of principle which merit discussion and which; as is often the case in debate about aquaculture, take the discourse into a much broader realm of philosophy and man's purpose in life. First, though we are confronted by great environmental challenges, is it an appropriate response merely to try to conserve rather than to seek instead to manage and build on the resources that have been given to us? Second is the concept of relative costs, or comparative ecological footprints. As we strive to build on our resources, there will be environmental costs and risks that things will not always go as expected. There is no hiding from the fact that in the short and medium term, as an offshore aquaculture industry strives to develop it may (like any aquaculture operation elsewhere) incur ecological costs, including:

- use of feed materials from several external sources;
- discharge of wastes into marine waters;
- the potential for escapes of domesticated stock which, if they breed with wild stock, may impact them genetically; and
- the potential for release of pathogens if farmed stock become infected, which may then heighten the risks of disease in wild stock.

All of these actual or potential costs will either draw on environmental services or risk negative environmental consequences. But are these more or less than the burdens imposed by other forms of food production, such as deforestation or soil erosion in terrestrial agriculture, or degradation by certain commercial fisheries at sea? It is impossible to satisfy humanity's need

for food with zero impact. Therefore, in weighing the possible impacts of a new form of food production—such as offshore aquaculture—the alternatives must be compared.

Offshore aquaculture is opposed or criticized by parts of two general constituencies: the commercial fishing industry and environmental NGOs. The commercial fishing industry is concerned about aquaculture being a competitive source of supply and about possible environmental consequences that could threaten the resource it harvests. Environmental NGOs also worry about environmental issues and about setting in motion an industry whose future scale and consequences are unknown.

To address these concerns, we need a dispassionate comparison between commercial fishing, aquaculture, and other forms of food production and of the role that aquaculture can play in an integrated approach to managing marine ecosystems. We also need a better understanding of the synergies between fishing and aquaculture, how fishermen can benefit from aquaculture, and of the effects of the globalization of the seafood trade on U.S. production of seafood. Today's clamor for sustainability will eventually ensure that such matters are addressed and that those on all sides are judged without prejudice.

### **Private Use of Marine Lands**

In its final report, “An Ocean Blueprint for the 21<sup>st</sup> Century,” the U.S. Commission on Ocean Policy offers a primer on ocean jurisdictions under the title, “Drawing Lines in the Water”. In general, both the states and the federal government must exercise authority over the nation's waters “for the benefit of the public” under *The Public Trust Doctrine*, which originates from ancient Roman and English common law. Given such ancient origins, it is hardly surprising that the obligation that the doctrine imposes has had to be interpreted, modified, and adjudicated numerous times in response to new circumstances, and there is a large body of law to reflect this work.

Aquaculture in marine waters introduces another new circumstance that could not have been foreseen in earlier interpretations of the doctrine and for which a new body of law will have to evolve. In the same way that society has evolved rules to govern rights to use of the airwaves for communication, the skies for air transport, the sea for commercial fishing and the sea bed for mineral extraction, it is also clearly possible to provide new laws for offshore aquaculture. But this pre-supposes that the political will to do so exists.

As the process moves forward, however, it is possible to imagine certain outcomes and to respond proactively to some concerns. First, for offshore aquaculture to succeed, small parts of the EEZ will need to be privatized, albeit through permits rather than titled ownership. In other words, government has to act as a partner in this development because government is the owner (*The Public Trust Doctrine* notwithstanding) of the aquatic real estate that will be farmed.

Parallels with the homesteading laws of earlier times are relevant here. In order to encourage settlement and productive use of western lands, the government provided not only permission but also incentive to those with the will and the drive to challenge a new frontier.

There are reasons to think that the oceans now represent such a frontier and, once again, it is government's task to act as both the enabler and the steward.

In this context, it is interesting to compare the development of the U.S. catfish farming industry with various approaches to sea-based aquaculture. On land (albeit land that is excavated to make ponds), land-use law and the principle of private property is clearly established. In fact, it is enshrined in our essential freedoms. Thus, there was little to deter landowners and traditional farmers in the South from digging ponds and becoming catfish farmers once they recognized this as good business. In other words, they were free, within reason, to do what they wanted with their land and they knew that their investment would be secure, and might even increase in value as commercial success was proved. The result is a world-class industry that now produces over 70% of all aquacultured products in America.

Examples of privately owned marine property are rare but they do exist. For example, tidelands in the State of Washington have been privately owned and used for shellfish farming since statehood, providing the owners with a bankable asset that appreciates in value. Private ownership has even been found helpful in some commercial fisheries, where allocation and subsequent ownership of fishery quotas provides the motivation to better husband the resource and manage the supply.<sup>8</sup> Such quotas are also bankable; in fact, selling quotas has provided some with a lucrative exit from the commercial fishing industry.

Since the days of claim-staking and unrestricted access to natural resources have passed, it is incumbent on government leaders to do three things:

1. Establish a schedule of permit fees that at one and the same time recover a fair rent for use of public waters, while acknowledging the commercial risk and the international competition that offshore fish farmers must deal with.
2. Establish ownership criteria that encourage local and national investment, while being consistent with international trade law and recognizing the reciprocal rights that Americans are usually accorded when investing overseas themselves.
3. Consider how the economic multiplier benefits of investment in offshore aquaculture can help those in coastal communities who are most in need, without imposing constraints that may inhibit the investment to begin with.

There are models and precedents for dealing with these matters in many branches of American commerce. Particularly relevant is the policy that makes federal lands available for the grazing of livestock, where fees are charged based on the number of animals the land will support. It is noteworthy that grazing occurs on 235 million acres of federal lands for a variety of purposes (GAO, 2005), which stands in marked contrast to the estimates provided earlier with regard to the surface and seabed areas required for aquaculture. It is to be hoped that, just because in this case we are dealing with the sea, the temptation will be resisted to re-invent wheels, and that existing practices—such as livestock grazing on public lands—can and will be used as models.

---

<sup>8</sup> The most commonly use acronym for these today is LAPPs – Limited Access Privilege Programs.

An often heard comment in the discourse over marine aquaculture in America is that it can only work in countries with weak environmental regulations; that it will not develop in America because regulations here are too tough. This is not true. No business can operate in a lawless society, be it laws governing the environment or private property. Serious investors in aquaculture need tough environmental regulations and strong private property assurances to protect them from the capricious acts of government or criminal acts of individuals. The aquaculture industry is not looking for lax environmental standards or a free ride on the resources it uses, but instead, for regulatory clarity, certainty, and stability. State regulations already in place in Maine, Washington, Florida, and Texas, and regulations in other industrialized countries, provide good examples of what the industry expects and NOAA has in mind regarding environmental matters. Federal law that protects property rights from real estate to the air waves provides adequate prior guidance on which to base a fair and enabling system of marine leasing. If America is to take a lead in this new industry, as it can and should, its practitioners need and expect no less.

## References

- Asgard, T., E. Austreng, I. Holmefjord, M. Hillestad, and K. Shearer. 1999. Resource efficiency in the production of various species. Proceedings of the Second International Symposium on Sustainable Fish Farming. Oslo, Norway. Nov.2-5<sup>th</sup> 1997, Publ. A.A. Balkema, Rotterdam.
- Brown, L.R. 2005. *Outgrowing the Earth: The Food Security Challenge in an Age of Falling Water Tables and Rising Temperatures*. NY: W.W Norton & Co., 2004.
- Bunge. Undated. [http://www.bunge.com/US/en/industry\\_information/afoa\\_slides.pdf](http://www.bunge.com/US/en/industry_information/afoa_slides.pdf)
- Chynoweth, D.P., J.M. Owens, and R. Legrand. 2001. Renewable Methane from Anaerobic Digestion of Biomass. *Renewable Energy* 22:1-8.
- Cicin-Sain, B., S. M. Bunsick, J. Corbin, M. R. DeVoe, T. Eichenberg, J. Ewart, J. Firestone, K. Fletcher, H. Halvorson, T. MacDonald, R. Rayburn, R. Rheault and B. Thorne-Miller. 2005. Recommendations For An Operational Framework For Offshore Aquaculture In U.S. Federal Waters. Gerard J. Mangone Center for Marine Policy, University of Delaware, Newark. Available at: <http://darc.cms.udel.edu/sgeez/sgeez2final.pdf>
- Delgado, Christopher L., Nikolas Wada, Mark W. Rosegrant, Siet Meijer, and Mahfuzuddin Ahmed. 2003. *Fish to 2020, Supply and Demand in Changing Global Markets*. International Food Policy Research Institute, Washington, D.C., 226 pp.
- FAO. 2005. *The State of the World Fisheries and Aquaculture. PART 1: World review of fisheries and aquaculture, Overview*. [www.fao.org/docrep/007/y5600e/y5600e04.htm](http://www.fao.org/docrep/007/y5600e/y5600e04.htm)
- FAO. 2007. *FishStat Plus: Universal Software for Fishery Statistical Time Series*.
- Geider, Richard J., et al. 2001. Primary productivity of planet earth: biological determinants and physical constraints in terrestrial and aquatic habitats. *Global Change Biology* 7:849-882.



Government Accountability Office. 2005. *Livestock Grazing*.  
<http://www.gao.gov/new.items/d05869.pdf>

Huesemann, M.H. 2006. Can Advances in Science and Technology Prevent Global Warming? A Critical Review of Limitations and Challenges. *Mitigation and Adaptation for Global Change* 11(1).

NOAA. 2007. NOAA 10-Year Plan for Marine Aquaculture. Available at  
<http://aquaculture.noaa.gov/pdf/finalnoaa10yrrweb.pdf>

Naylor, R. et al. 2000. Effects of aquaculture on world fish supplies. *Nature* 405, 1017-1024.

Rust, M. B. 2002. Nutritional Physiology. Chapter 7 in R. W. Hardy and J. H. Halver (ed.), *Fish Nutrition*, 3rd ed., San Diego: Elsevier Science. pp 367-452.

Stickney, R.R., B. Costa-Pierce, D.M. Baltz, M. Drawbridge, C. Grimes, S. Phillips and D.L. Swann. 2006. Toward Sustainable Open Ocean Aquaculture in the United States. *Fisheries* 31(12):607-610

Tacon, Albert. 2005. State of information on salmon aquaculture feed and the environment. World Wildlife Federation, special publication.

UN Millennium Environmental Assessment. 2005.

U.S. Commission on Ocean Policy. 2004. An Ocean Blueprint for the 21<sup>st</sup> Century. Final Report. Washington, D.C.

Waggoner. 1994. How much land can ten billion people spare for nature? Task force report, ISSN 0194-4088: no. 121. <http://www-formal.stanford.edu/jmc/nature/nature.html>

Wild, Ruedi. 1997. Snapshot of the world feed industry: Global Perspective. *Feed Management* 48(7):10-13.

*This page intentionally left blank.*

## Background on the Authors

---

### **Dr. James L. Anderson – University of Rhode Island**

Dr. James Anderson is the Chairman of the Department of Environmental and Natural Resource Economics at the University of Rhode Island in Providence, where he has been a professor since 1983. His research has focused on aquaculture markets, seafood safety, seafood price forecasting, analysis of seafood markets, market structure and other pricing mechanisms, and the relationship between the seafood market and environmental policies and regulation. Dr. Anderson has authored or co-authored four books, over 30 peer-reviewed articles, and multiple book chapters. He has served as editor of *Marine Resource Economics* since 1999. He received the Outstanding Ph.D. Thesis Award from the American Agricultural Economics Association (1984), Research Scientist of the Year Award from the University of Rhode Island's College of Environment and Life Sciences (1994), and the Article of the Year Award from the Editorial Board of *Agricultural and Resource Economics Review* (1995). Dr. Anderson holds a Ph.D. in Agricultural and Resource Economics from the University of California–Davis.

### **John Forster – Forster Consulting**

Mr. John Forster is an aquaculture consultant with over 40 years of experience in the industry. Initially a government researcher in the United Kingdom, he moved to the business sector with Shearwater Fish Farming in 1974, where he ran a commercial trout farm and established an international technical services business. In 1984, Mr. Forster moved to Port Angeles, Washington, where he helped Stolt Sea Farm develop its West Coast salmon and sturgeon farming operations. In 1994, he founded Columbia River Fish Farms LLC, the largest U.S. producer of steelhead trout, and served as its president until 2005. A consultant to clients in both the public and private sectors, he has a special interest in the application of experience from the farmed salmon industry to new aquaculture species. He is currently the director of four aquaculture companies. He also serves on NOAA's Marine Fishery Advisory Committee, which advises the Secretary of Commerce on living marine resource matters.

### **Dr. Di Jin – Woods Hole Oceanographic Institution**

Dr. Di Jin is an Associate Scientist at the Marine Policy Center of the Woods Hole Oceanographic Institution in Woods Hole, Massachusetts. He specializes in the economics of marine resources management and marine industries. Dr. Jin has substantial research experience with the commercial fishing and aquaculture industries, the offshore oil and gas industry, and the marine transportation industry, and has experience working on coastal management problems. His papers have been published in numerous journals, including *Aquaculture Economics and Management*, *Environmental and Resource Economics*, *Journal of Environmental Economics and Management*, *Land Economics*, and *Marine Resource Economics*. He holds a Ph.D. in Economics–Marine Resources from the University of Rhode Island.

## Background on the Authors

---

### **Dr. James E. Kirkley – College of William and Mary**

Dr. James Kirkley is a Professor of Marine Science in the Department of Fisheries Science at the College of William and Mary in Williamsburg, Virginia. From 2000 to 2005, Dr. Kirkley was the Chairman of the Department of Coastal and Ocean Policy at William and Mary. From 1978 to 1986, he was the Chief of Economic Investigations at NOAA's Northeast Fisheries Science Center in Gloucester, Massachusetts. His primary research interests include fisheries economics, marine policy, marine resource management, economic impact analysis, economic valuation of market and non-market goods and services, fisheries management, aquaculture, and fisheries production. He holds a Ph.D. in Agricultural and Resource Economics from the University of Maryland.

### **Dr. Gunnar Knapp – University of Alaska–Anchorage**

Dr. Gunnar Knapp is a Professor of Economics at the University of Alaska's Institute of Social and Economic Research in Anchorage, where he has conducted a wide variety of research on Alaska's economy and natural resources, including markets for Alaska seafood and the management of the state's fisheries resources. In particular, Dr. Knapp has studied markets for Alaska salmon and other fish species and how they have been affected by competition from farmed salmon and other factors. He is also interested in how the Alaska seafood industry has responded to changes in world seafood markets. Dr. Knapp co-authored the 2007 report, *The Great Salmon Run: Competition Between Wild and Farmed Salmon*, which examines the economic and policy issues surrounding wild and farmed salmon in North America. Dr. Knapp holds a Ph.D. in Economics from Yale University.

### **Colin E. Nash – NOAA Fisheries Service (retired)**

Mr. Colin Nash was Director of the Aquaculture Development and Coordination Programme at the Food and Agriculture Organization of the United Nations in Rome during the 1980s, followed by four years as the technical director of Cofrepêche, an international firm in France specializing in coastal management issues. After his return to the United States in 1998, Mr. Nash joined the aquaculture group at the NOAA Northwest Fisheries Science Center's Manchester Research Station near Seattle. For 10 years he was the Editor-in-Chief of the first aquaculture journal, *Aquaculture*. He has published a number of papers on aquaculture, including, most recently, *Guidelines for Ecological Risk Assessment of Marine Fish Aquaculture* (NOAA Technical Memo, December 2005) and *Achieving Policy Objectives to Increase the Value of the Seafood Industry in the United States: The Technical Feasibility and Associated Constraints* (Food Policy, December 2004). In 2005, Mr. Nash was made an Honorary Member of the European Aquaculture Society.

## Background on the Authors

---

### **Dr. Michael C. Rubino – NOAA Aquaculture Program**

Dr. Michael Rubino is the manager of NOAA's Aquaculture Program. He joined the agency in 2004 to lead NOAA's renewed commitment to marine aquaculture. Most recently, Dr. Rubino was the Manager of New Funds Development for the World Bank's Carbon Finance Group. In the 1990s, Dr. Rubino worked at the International Finance Corporation, a private sector affiliate of the World Bank, where he developed renewable energy and biodiversity investment funds. Prior to that, he was the CEO of Bluewaters, Inc., an aquaculture research and development company, and a partner in Palmetto Aquaculture, a shrimp farm in South Carolina. Dr. Rubino also served as vice-chairman of the State of Maryland's Aquaculture Advisory Committee. He holds a Ph.D. in Natural Resources from the University of Michigan.

### **Gina L. Shamshak – University of Rhode Island**

Ms. Gina Shamshak is a Ph.D. candidate in Environmental and Natural Resource Economics at the University of Rhode Island. She holds M.A. and B.A. degrees in Economics from Boston University. In 2005, she was one of 40 students chosen nationally for the John A. Knauss Sea Grant Fellowship Program. Her research interests include fisheries and aquaculture economics and management, environmental policy, risk analysis, bioeconomic modeling, and international trade. Ms. Shamshak is currently researching the economics of bluefin tuna aquaculture for her dissertation.

### **Diego Valderrama – University of Rhode Island**

Mr. Diego Valderrama is a Ph.D. candidate at the Department of Environmental and Natural Resource Economics, University of Rhode Island. He holds a B.S. degree in Marine Biology from the Universidad Jorge Tadeo Lozano (Bogota, Colombia) and an M.Sc. in Aquaculture and Fisheries from the University of Arkansas at Pine Bluff. He has published nearly a dozen journal articles and several book chapters on various issues in aquaculture and fisheries economics. He has extensive experience in the analysis of global shrimp and salmon markets. Mr. Valderrama has researched the economics of shrimp farming in Latin America, catfish farming in the southeastern United States, and the optimization of management strategies for sea scallop stocks in the northwest Atlantic Ocean. His current dissertation work involves analyzing market interactions between aquaculture and traditional capture fisheries, examining the economic climate of the Alaskan salmon fisheries, and formulating recommendations for improving competitiveness of the fishing industry with the aquaculture sector.







**U.S. Department of Commerce  
National Oceanic & Atmospheric Administration  
Silver Spring, Maryland**

**You may download an electronic version of this report from:  
<http://aquaculture.noaa.gov>**

**For more information:**

**NOAA Aquaculture Program  
1315 East-West Hwy.  
SSMC #3 – Room 13117  
Silver Spring MD 20910  
(301) 713-9079**

**E-mail: [noaa.aquaculture@noaa.gov](mailto:noaa.aquaculture@noaa.gov)  
Website: <http://aquaculture.noaa.gov>**